

Experimental Method for Early Age Properties

JOEY EL- RASSI



POLITECNICO
MILANO 1863

**AN EXPERIMENTAL METHOD TO MEASURE VERY EARLY AGE FRACTURE
PROPERTIES OF HPCRCS**

Acknowledgements

The following study reports my work on An Experimental Method to Measure Very Early Age Fracture Properties of HPFRCCs (High Performance Fiber-Reinforced Cementitious Composites) as a graduation thesis. It is the final requirement of the MSc in Civil Engineering – track Structures at the Politenico di Milano.

The project has been carried out under the supervision of Associate Prof. PhD Liberato Ferrara, and Eng. Francesco Lo Monte. I would like to thank my colleague Gabriele Zago for his contribution to this project.

Finally, I would like to thank my family and friends who have supported me throughout my stay at Politecnico.

Joey El- Rassi

Milan, September 2018

Abstract

With the recent advancements in technology, novel techniques have been developed in the past few decades in order to automate the production process, rendering it more efficient. 3D printing which is an additive manufacturing layer-based technique have found particular success in a variety of fields. Its speed, efficiency, and ease of customization at no added cost make it a convenient acquirement to the on-site and precast building industry. Promising work has been done for developing 3D printing for building from a number of companies and laboratories, however, the industry still lags behind. This is due to the lack of research in the structural field on the behavior of the printed shapes. This thesis study aims at providing a reliable experimental method in order to test strength development properties in fresh concrete.

A literature review exposes the background of additive manufacturing from relief maps to sculpture applications. Later advancements enabled the development of user-friendly home 3D printers, as well as bigger 3D printers for industrial production purposes. Different types of printing techniques are explored and the materials best optimized for each process are highlighted.

3D printing in the construction industry provides an insight about the latest findings and achievements done in the field. Three major printing techniques, along with their benefits and advantages are discussed. Different companies that have also taken initiative towards exposing the benefits of 3D printing are also mentioned.

In order to develop a working testing method, properties of fresh concrete and tests previously done on printed concrete are studied. Connections between early strength development, printing orientation, and fresh concrete rheology are demonstrated from literature articles.

Considering limitations such as printer size and nozzle diameter, mix designs previously designed for printing processes are presented. The problem of reinforcement in 3D printing of concrete is solved with the use of reinforcing fibers with maximum possible length and diameter. Fiber reinforcement helps in further automating the building process, where no additional manual labor would be needed for steel bars installment (or minimal).

Based on the above information and limitations, shear and tensile testing apparatuses were designed and are adopted in the current study. Two concrete mix designs are used, one for shear testing, and the other for tensile testing. Performed at different times, these tests demonstrate the development of very early strength (min. 100 minutes) in cementitious composites. The experimental program details the performed tests and presents the findings. In addition, a clear connection between concrete rheology and strength development is found, by means of slump tests performed at different times.

The findings of this thesis may serve as a step towards developing a reliable testing method for early strength characteristics of concrete, especially for applications in the 3D printing building industry. By further studying the properties and characteristics of printed cementitious composites, the amelioration of mix designs and their optimization for 3D printing is possible. Backed up by further research, these testing methods would help implement 3D printing in the building industry.

Table of Contents

ACKNOWLEDGEMENTS	2
ABSTRACT	3
I. Introduction	13
II. Literature Review	14
1. Additive Manufacturing	16
2. 3D Printing Techniques	18
2.1.VAT Photopolymerization	18
2.1.1. Stereolithography	18
2.1.2. Direct Light Processing	20
2.1.3. Continuous Direct light Processing	20
2.2.Sheet Lamination	21
2.2.1. Laminated Object Manufacturing	21
2.3.Material Jetting	22
2.3.1. Material Jetting	22
2.3.2. Nano-Particle Jetting	22
2.3.3. Drop on Demand	23
2.4.Binder Jetting	24
2.4.1. Binder Jetting	24
2.5.Powder Bed Fusion	25
2.5.1. Selective Laser Sintering	25
2.5.2. Multi Jet Fusion	26
2.5.3. Direct Metal Laser Sintering/Selective Laser Melting	27
2.5.4. Electron Beam Melting	28
2.6.Direct Energy Deposition	29
2.6.1. Laser Engineering Net Shape	29

2.6.2. Electron Beam Additive Manufacturing	30
2.7. Material Extrusion	30
2.7.1. Fused Deposition Modeling	31
3. 3D Printing in the Construction Industry	33
3.1. Contour Crafting	35
3.2. D-Shape	40
3.3. 3D Concrete Printing	43
3.4. YingChuang	47
3.5. HuaShang Tengda	48
3.6. TotalKustom	49
4. Printable Concrete Characteristics	52
5. Mix Designs	59
6. Reinforcement in 3D Printable Concrete	61
III. Experimental Program.....	64
1. Shear Apparatus	66
2. Tensile Apparatus	68
3. Mix Composition	70
3.1. Cement	70
3.2. Grounded Blast Furnace Slag	70
3.3. Sand	71
3.4. Superplasticizer	71
3.5. Fiber Reinforcement	72
3.6. Water	72
4. Experimental Mix Design	72
5. Mix Protocol	74
6. Material Testing	75
6.1. Shear Test	75
6.2. Tensile Test	76
6.3. Slump Test	77
IV. Experimental Results	78
1. Experimental Data	78

2. Shear Analysis	89
3. Tensile Analysis	90
4. Slump Analysis	92
V. Conclusion and Further Work	94

List of Figures

Figure 1. Layered Wax Molds (Blanther, 1892)

Figure 2. Baese Photo Sculpture Technique (Baese, 1904)

Figure 3. Swainson Laser Technique (Swainson, 1977)

Figure 4. Ciraud Powder Technique (Ciraud, 1972)

Figure 5. SLA Setup (3dhubs.com)

Figure 6. DLP Setup (3Dprintingindustry.com)

Figure 7. LOM Paper Sheets Setup (3dprintingindustry.com)

Figure 8. Material Jetting Printer (3dhubs.com)

Figure 9. Binder Jetting Model (additively.com)

Figure 10. Binder Jetting End Product (3dhubs.com)

Figure 11. SLS Printer (3dcompare.com)

Figure 13. DMLS Machine (lasersintering.com)

Figure 14. EBM Process (additively.com)

Figure 15. LENS Process Scheme (Griffith et al, 1996)

Figure 16. EBAM Process (Sciaky.com)

Figure 17. FDM Process Scheme (additively.com)

Figure 18. Additive Manufacturing Overview (3dhubs.com)

Figure 19. Cheap Housing Using Concrete 3D Printing (theverge.com)

Figure 20. Extrusion and Filling Mechanisms (Hwang and Khoshnevis, 2005)

Figure 21. Single Nozzle with Trowels Assembly (Hwang and Khoshnevis, 2005)

Figure 22. Material Filling Using a Multiple Nozzle System (Hwang and Khoshnevis, 2005)

Figure 23. Multiple Outlet CC Printer Model (contourcrafting.org, 2014)

Figure 24. 2D Slicing (2013)

Figure 25. CC printed Structures and Machine (top right) (Lim et al, 2011)

Figure 26. 5m*5m*5m D-Shape Printer (Krassenstein, 2014).

Figure 27. D-Shape printed Sculptures (d-shape.com).

Figure 28. D-Shape Printed House (d-shape.com).

Figure 29. Concrete Printing Machine (Lim et al, 2011).

Figure 30. Delivery and Refill Processes (Lim et al., 2011).

Figure 31. 3D Printed Silo (Lim et al, 2011)

Figure 32. 3D Printed Bed (Lim et al, 2011).

Figure 33. “Wonder Bench” (Lim et al, 2012).

Figure 34. YingChuang 3D Printing Technology (winsun3d.com).

Figure 35. Two-story 3D printed house (3dprint.com).

Figure 36. 3D Printed Suite (totalkustom.com).

Figure 37. 3D Printed Miniature Castle (totalkustom.com).

Figure 38. Earthquake Resisting Quake Column (emergingobjects.com).

Figure 39. Water Absorbing “Cool Brick” (emergingobjects.com).

Figure 40. 3D Printing Process (Paul et al, 2017).

Figure 41. Slump Test Representation (Ferraris, 1999).

Figure 42. Force Direction (Nerella et al, 2016)

Figure 43. Flexural Test Loading (2016).

Figure 44. Concrete Mix Preparation.

Figure 45. 3D Printed Pedestrian Bridge – Gemert, Netherlands (3dprint.com).

Figure 46. Experimental Testing Setups (Mettler et al, 2016).

Figure 47. Shear Mold Dimensions (mm) – Taken from AutoCAD 2016

Figure 48. Empty Shear Testing Apparatus

Figure 49. Full Shear Testing Apparatus

Figure 50. Tensile Mold Dimensions (mm) – Taken from AutoCAD 2016

Figure 51. Empty Tensile Testing Apparatus

Figure 52. Full Tensile Testing Apparatus

Figure 53. GBFS (indiamart.com)

Figure 54. Steel Fibers (AZICHEM Ltd)

Figure 55. Mixing Metal Bowl.

Figure 56. Transducer Push System.

Figure 57. Shear Test.

Figure 58. Tensile Test

Figure 59. Performed Slump Test.

Figure 60. Shear Test 1 at 110mins.

Figure 61. Shear Test 2 at 200mins.

Figure 62. Shear Test 3 at 140mins.

Figure 63. Shear Test 4 at 170mins.

Figure 64. Shear Test 5 at 210mins.

Figure 65. Shear Test 6 at 110mins

Figure 66. Shear Test 7 at 150mins.

Figure 67. Shear Test 8 at 130mins.

Figure 68. Shear Test 9 at 160 mins.

Figure 69. Tensile Test 1 at 100mins.

Figure 70. Tensile Test 2 at 190mins.

Figure 71. Tensile Test 3 at 140mins.

Figure 72. Tensile Test 4 at 175mins

Figure 73. Tensile Test 5 at 200mins.

Figure 74. Tensile Test 6 at 110mins.

Figure 75. Tensile Test 7 at 145mins.

Figure 76. Tensile Test 8 at 130mins.

Figure 77. Tensile Test 9 at 150mins.

Figure 78. Slump (mm) vs. Time (min) Scatter of Mix 1.

Figure 79. Slump (mm) vs. Time (min) Scatter of Mix 2.

Figure 80. Shear Failure at 130mins.

Figure 81. Shear F vs D Superposition.

Figure 82. Tension Failure.

Figure 83. Tensile F vs. D Superposition.

Figure 84. Strength Evolution vs. Yield Stress Build Up.

List of Tables

Table 1. 3D Concrete Printing Trial Mix Proportions (Le et al., 2011).

Table 2. Mold Dimensions (Mettler et al, 2016).

Table 3. Data Input.

Table 4. Mix Design.

Table 5. Cementitious Composite Mixes.

Table 6. Time Elapsed (minutes).

Table 7. Shear Trial 1 Results.

Table 8. Shear Trial 2 Results.

Table 9. Shear Trial 3 Results.

Table 10. Shear Trial 4 Results.

Table 11. Tensile Trial 5 Results.

Table 12. Tensile Trial 6 Results.

Table 13. Tensile Trial 7 Results.

Table 14. Tensile Trial 8 Results.

An Experimental Method to Measure Very Early Age Fracture Properties of HPFRCCs

I. Introduction

Cost, efficiency, and sustainability are the main concerns when it comes to any industry.

Scientists and engineers around the world aim at optimizing these parameters. With the recent advancements in many sectors, most notably technology, novel techniques have been incorporated in the production process. 3D printing, a concept based on additive manufacturing, is one of the newest cutting-edge technologies being used in a wide variety of fields including medicine, construction, prototyping, and industrial manufacturing. Additive manufacturing is a process by which any part or final three-dimensional object is obtained by depositing a selected material layer by layer (**Conner et al, 2014**). 3D printing has seen significant advancements in the last decade, with its applications ranging from consumer-friendly household printers to aerospace engineering, and from the food industry to the medical world (**theengineer.co.uk**).

Although advancements in many industries have been fast, one in particular still lags behind. The construction industry is yet to embrace the new technology on a larger and more significant scale. This is mainly due to the lack of research done on the properties of reinforced concrete mixes suitable for 3D printing. Structural designers of our time are capable of optimizing their designs, so that the load carrying capacity of a structure is maximized with an efficient (minimal) use of sustainable materials. “Creating complex objects with desirable material properties, cheaply, accurately and rapidly has been a continuing problem for designers.” (**Keisher, 2014**). These designs are difficult to realize using the old building techniques which turns heads towards 3D printing. The aim of this project is to develop suitable testing methods in order to determine the early strength characteristics of fresh concrete, to present solid grounds for the eventual optimization of a printable cementitious composite mix.

II. Literature Review

Although additive manufacturing is seen as a new technique, its concept and ideology trace back to the 19th century with topography and photo sculpture (**Beaman et al, 1997**). Transforming topographical maps into raised relief maps, by imposing printed paper after cutting along contour lines on wax plates leading to negative and positive surfaces, was one of the first forms of manually created 3D representations suggested by Blanther in the 1890's (**Blanther, 1892**).

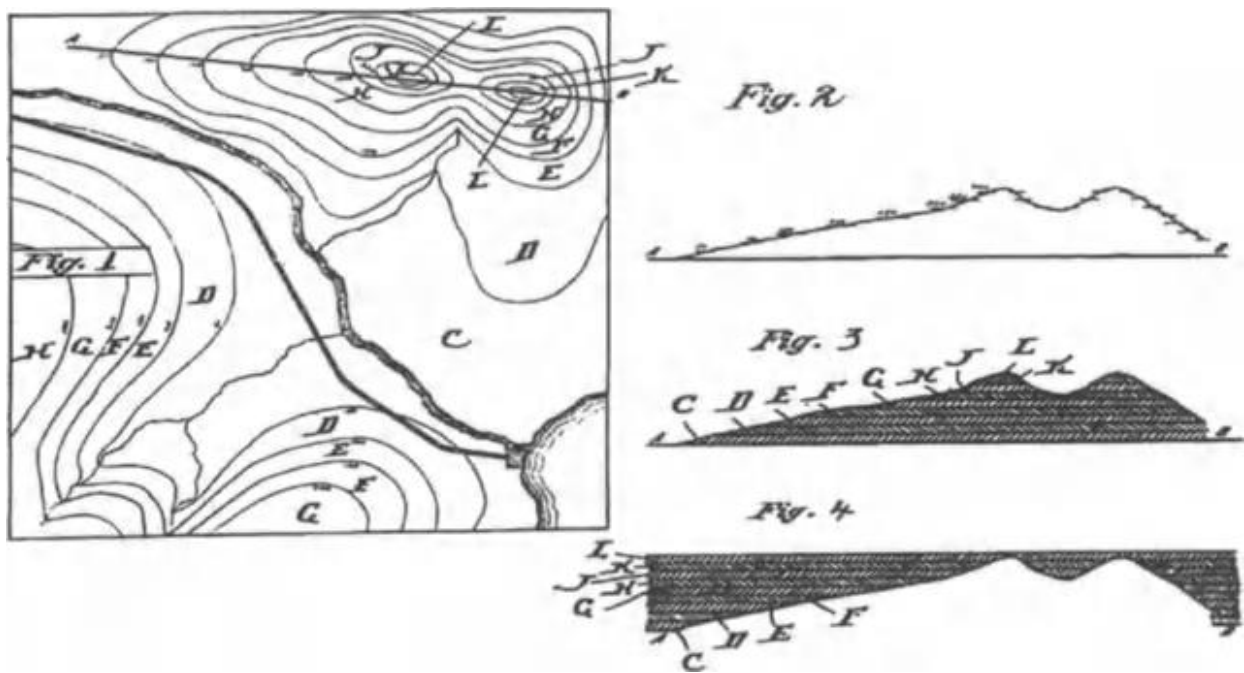
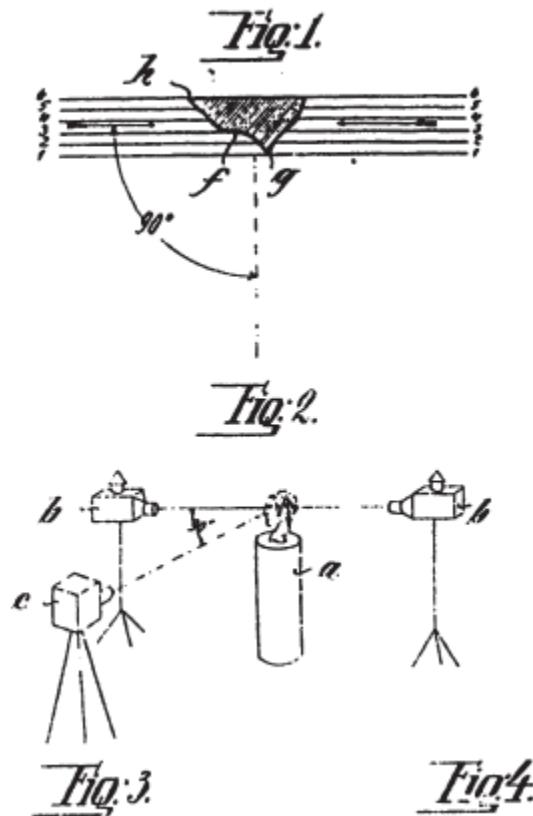

Figure 1. Layered Wax Molds (**Blanther, 1892**).

In parallel with Blanther's topographical invention, Baese suggested in the early 1900's using a photosensitive gelatin that expands in size proportionally to its light exposition after being treated in water for photo sculpture (**Baese, 1904**).



Figure

2. Baese Photo Sculpture Technique (Baese, 1904).

Shortly after, Perera suggested stacking cardboard piles cut according to the desired map's contour lines in order to recreate a 3D representation (Perera, 1940). The first apparent progress came from photo sculpting when Munz suggested a system that recreates layer-by-layer the cross-sections of scanned objects, using a movable piston and adding suitable amounts of fixing agents and photo emulsion (Munz, 1956). Later in 1972, a Mitsubishi Motors employee suggested using photo-hardening material for the topographical process (Matsubara, 1974). "In this process, a photopolymer resin is coated onto refractory particles (e.g., sand). These coated particles are then spread into a layer and heated to form a coherent sheet. Light is then selectively projected or scanned onto this sheet to harden a defined portion of it. The unscanned, unhardened portion is dissolved away by a solvent." (Beaman et al, 1997).

1. Additive Manufacturing:

ASTM F2792 defines additive manufacturing as “a process of joining materials to make objects from 3D model data, usually layer upon layer, as opposed to subtractive manufacturing methodologies” (ASTM, 2013). It is also notable to mention that additive manufacturing, more commonly known as 3D printing, differs from formative processes like casting or forging, and joining processes such as welding or fastening (Conner et al, 2014).

One of the earliest attempts to automate additive manufacturing was proposed by Swainson in 1968 (Swainson, 1977) when he described a process based on two radiation beams intersecting at a photosensitive polymer, creating a plastic.

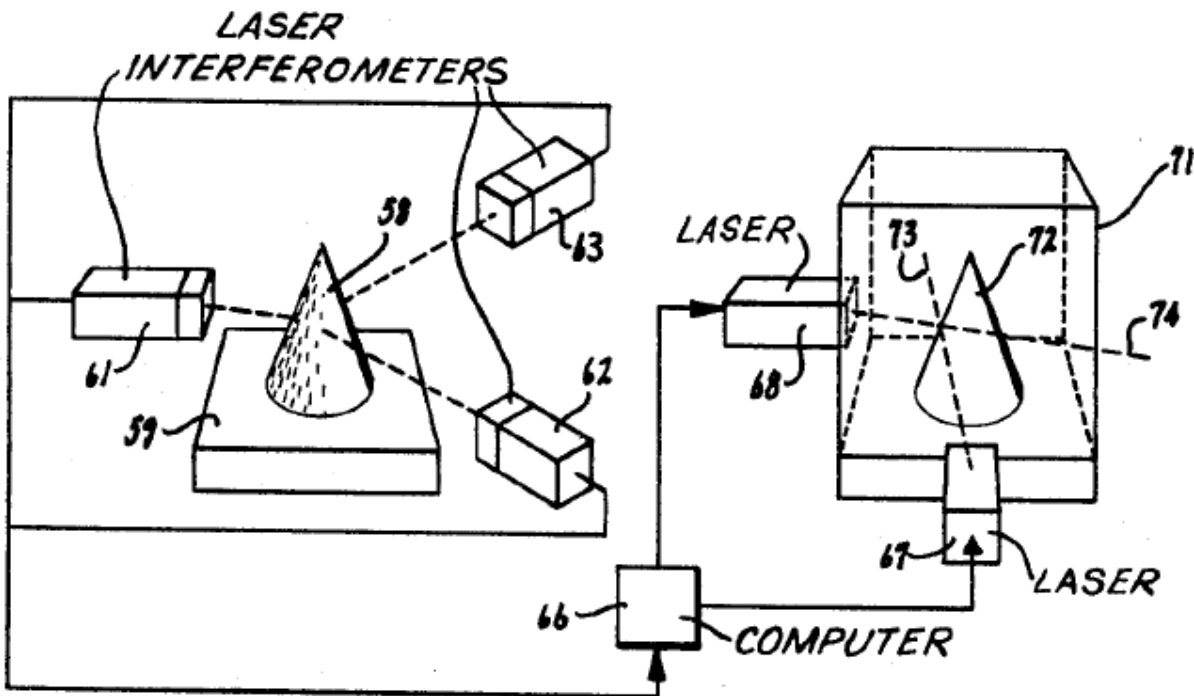

Figure 3. Swainson Laser Technique (Swainson, 1977).

Another method relying on heating meltable powders into adherence by laser, electron, or plasma was also suggested by Ciraud at around the same time (Ciraud, 1972).

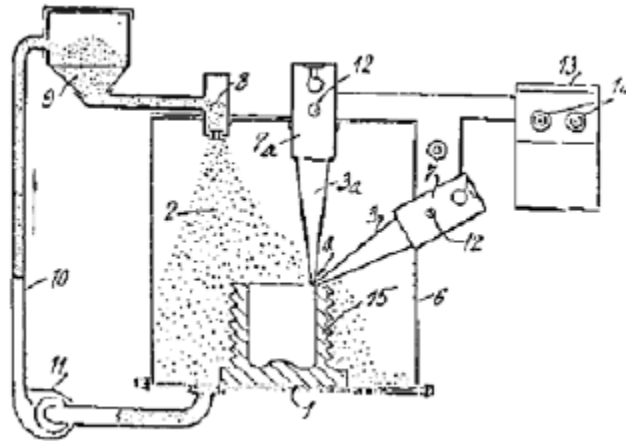

Figure 4. Ciraud Powder Technique (Ciraud, 1972).

Soon after, with the advancements in technology and the revelations of research, 3D printing turned into an essential part in many manufacturing fields. Its commercial use was also encouraged due to its speed and accuracy in producing customized shapes or objects (Conner et al, 2014). 3D printers are now readily available at reasonable prices and could be easily operated by the consumer using a specific software (theengineer.co.uk). Depending on the materials used and the desired characteristics of the end product, different 3D printing techniques are adopted by different sources. These processes will be briefly discussed, and their main operating companies mentioned in the following sections.

2. 3D Printing Techniques:

ASTM places additive manufacturing processes in seven categories, each relying on different techniques, technologies, and methods.

2.1 VAT Photopolymerization:

Vat Photopolymerization is “an additive manufacturing process in which liquid photopolymer in a vat is selectively cured by light-activated polymerization” (ASTM, 2013). In other words, a photopolymer resin placed in an apparatus is exposed to a beam of light at a specific wavelength, causing it to solidify. Three additive technologies fall under this category: Stereolithography, Direct Light Processing, and Continuous Direct Light Processing.

2.1.1 Stereolithography (SLA)

Stereolithography, commonly known as SLA, is an additive technology falling under the first category according to ASTM (2013). A build platform is submerged into a polymer resin bath (tank). A single laser in the machine is directed at the bottom of the tank, drawing the required cross section shape as the resin solidifies. After the bottom layer is solidified, the build platform is moved along the Z-direction, so that a new layer of polymer resin fills the bottom. The same process is repeated until the final shape is obtained. The object could then be exposed to UV light in order to enhance material properties (Jacobs, 1992). Usually, support structures that are made of the same material are needed and

removed or dissolved at the end of the process. SLA is the oldest and one of the most used 3D printing technology due to its cost effectiveness (**Hopkinson and Dickens, 2003**).

Top Down SLA printers are usually used for industrial purposes, while Bottom Up SLA printers could be operated from a desktop. Most notable desktop printer manufacturer is FORMLABS while the most popular industrial printer manufacturer is 3D SYSTEMS (**3dhubs.com**).

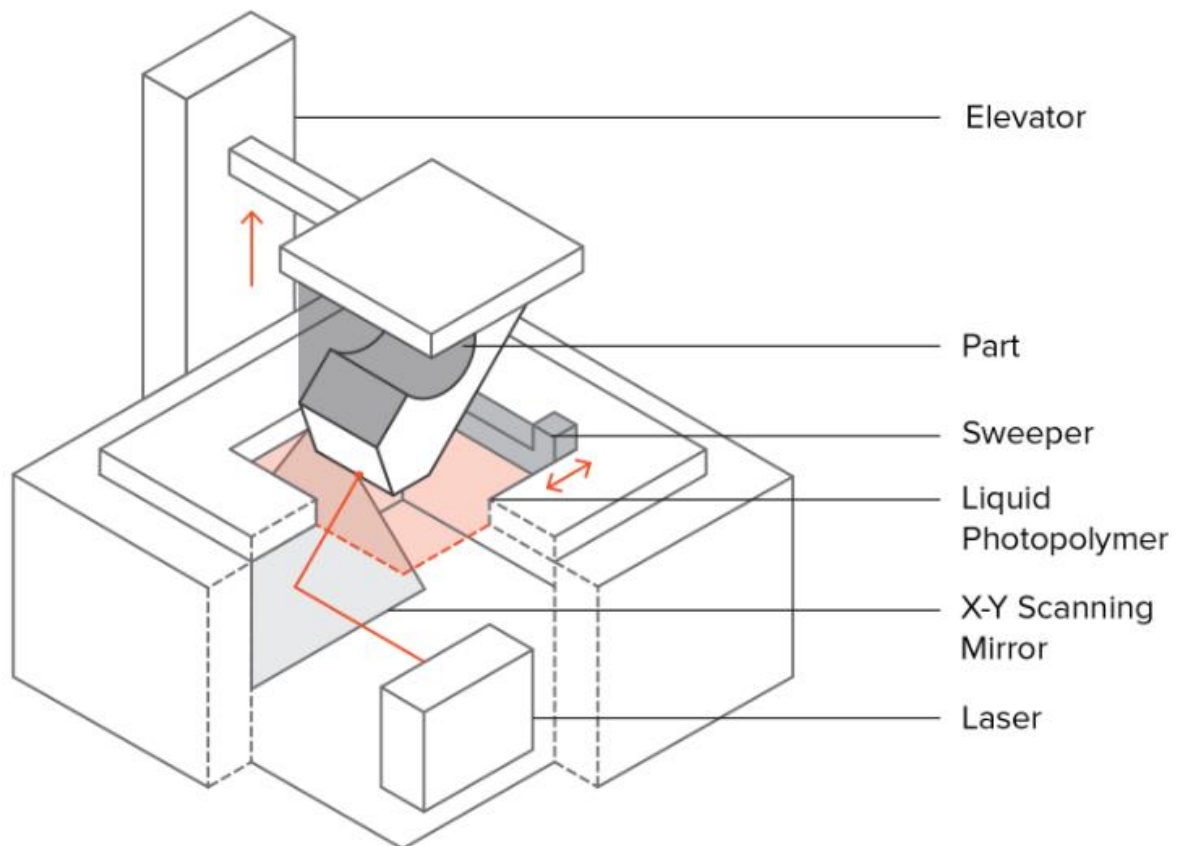

Figure 5. SLA Setup (**3dhubs.com**).

2.1.2 Direct Light Processing (DLP)

The second used technology in this category is Direct Light Processing, referred to as DLP. In comparison to SLA, DLP uses an identical method of production. Instead of drawing the desired cross section with a laser beam, a digital light projector screen flashes an image at the resin layer. Since images on projector screens are formed from pixels, this method results in end layers formed from small rectangular bricks known as “Voxels” (3dhubs.com). An entire layer of resin is solidified at once using the same projected image, causing DLP to result in faster print times than SLA.

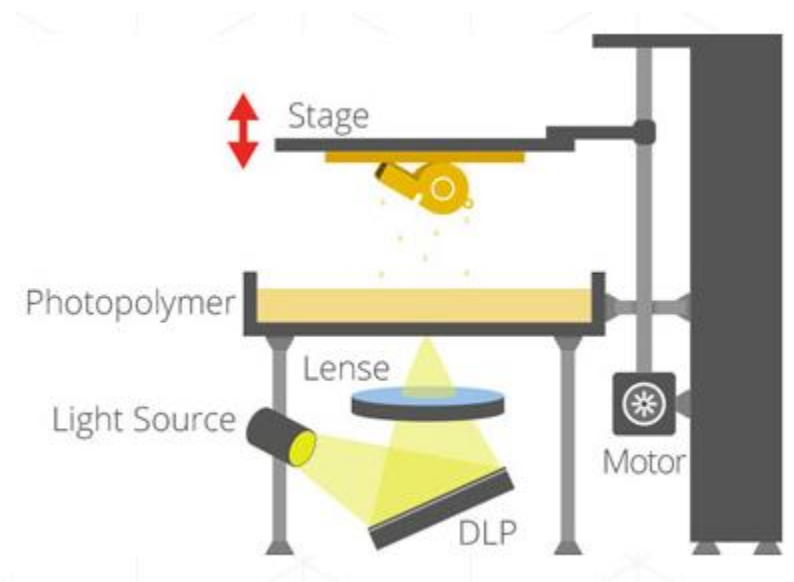

Figure 6. DLP Setup (3Dprintingindustry.com).

2.1.3 Continuous Direct Light Processing (CDLP)

The main difference between CDLP and DLP is the continuous upward movement of the build plate. Another notable difference between the two systems

is the curing of the resin polymer with LED lights and exposure to oxygen during CDLP.

2.2 Sheet Lamination

Sheet Lamination is defined by **ASTM (2013)** as an “additive manufacturing process in which sheets of material are bonded to form an object.” Highly detailed and colorful 3D objects are obtained from this method.

2.2.1 Laminated Object Manufacturing

Similar to other additive manufacturing techniques, sheets are cut by a laser beam in order to obtain the desired cross sections. These sheets are then placed layer by layer on top of each other and glued after being coated with an adhesive. The only present commercial LOM printers use paper sheets since they are cheapest and can be colored. Industrial printers are compatible with plastic foils and metal sheets.

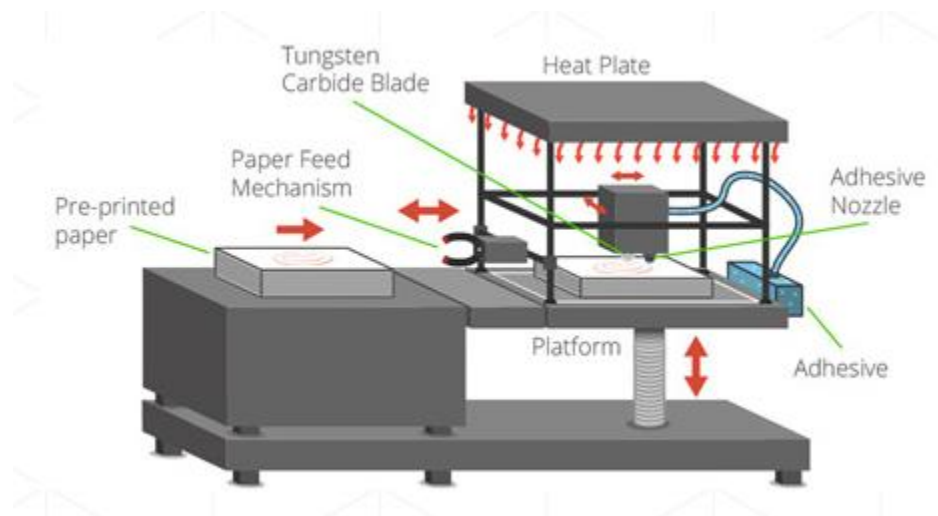

Figure 7. LOM Paper Sheets Setup (3dprintingindustry.com).

2.3 Material Jetting

Material Jetting is vaguely explained by **ASTM (2013)** as the process by which “droplets of build material are selectively deposited”. It includes three additive technologies, discussed briefly below.

2.3.1 Material Jetting

This technology jets out a photopolymer from several (hundreds) printer nozzles layer by layer on a build platform. Each photopolymer layer is exposed to UV light, which causes it to harden, and eventually form the final object shape.

Supports built simultaneously are often needed and disposed of or dissolved at the end of the printing process. Most common manufacturers for material jetting printers are STRATASYS and 3D SYSTEMS. Multi-color, multi-material, products with various properties can be printed using this technology.

2.3.2 Nano-Particle Jetting

Nano-Particle jetting differs from the classical material jetting in the substance that is excreted by the printer nozzles. Instead of secreting a photopolymer, a liquid containing metal nanoparticles is secreted. The build temperature is then increased in order to evaporate the liquid and have a 3D object made up of the leftover metals. Common manufacturers for NPJ printers are XJET company, which use stainless steel or ceramics.

2.3.3 Drop on Demand

DOD printers are characterized by two print jets: one that jets a wax-like liquid which later hardens in order to form the 3D object, and another that jets dissolvable support material. The cross section of the desired component is printed out by depositing the wax-like liquid in a pointwise fashion (**3dhubs.com**). Each build layer is then skimmed in order to ensure a flat surface. This technology is usually used in order to produce castings and molds. Common DOD printer companies include SOLIDSCAPE, which utilize wax in their 3D products.



Figure 8. Material Jetting Printer (**3dhubs.com**)

2.4 Binder Jetting

“Binder Jetting is an additive manufacturing process in which a liquid bonding agent is selectively deposited to join powder materials” (ASTM, 2013).

2.4.1 Binder Jetting

A binding adhesive agent is added to a thin layer of ceramic or metal -based powder materials. Agent droplets are deposited on the top of the powder material present on the build platform, causing them to bind together and solidify. The surface is then lowered and another layer of powder is sprayed with binding material droplets in an iterative process. This technology often produces brittle material which is why it is most convenient for aesthetic applications (architectural models, mini-models, packaging). 3D SYSTEMS, VOXEL, and EXONE are the most common manufacturers of BJ printers.

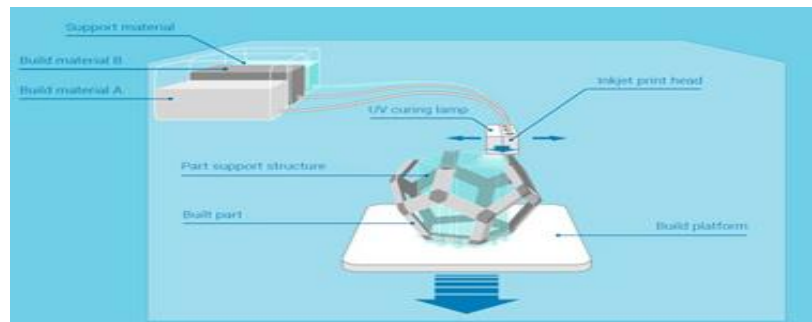

Figure 9. Binder Jetting Model (additively.com).



Figure 10. Binder Jetting End Product (3dhubs.com)

2.5 Powder Bed Fusion

Powder Bed Fusion (PBD) is “an additive manufacturing process in which thermal energy selectively fuses regions of a powder bed” producing solid layers (ASTM, 2013).

2.5.1 Selective Laser Sintering

SLS is an additive technology falling under the PBD category. A plastic powder is spread across the build surface, which is then sintered by a laser beam producing a certain solid cross section. The build platform is then lowered a layer thickness, and a new layer of powder is spread on top. The process is repeated until the final product is obtained. The product is usually covered with the powder material, and further post-processing is required to smoothen the surface. (Pham and Gault, 1997).

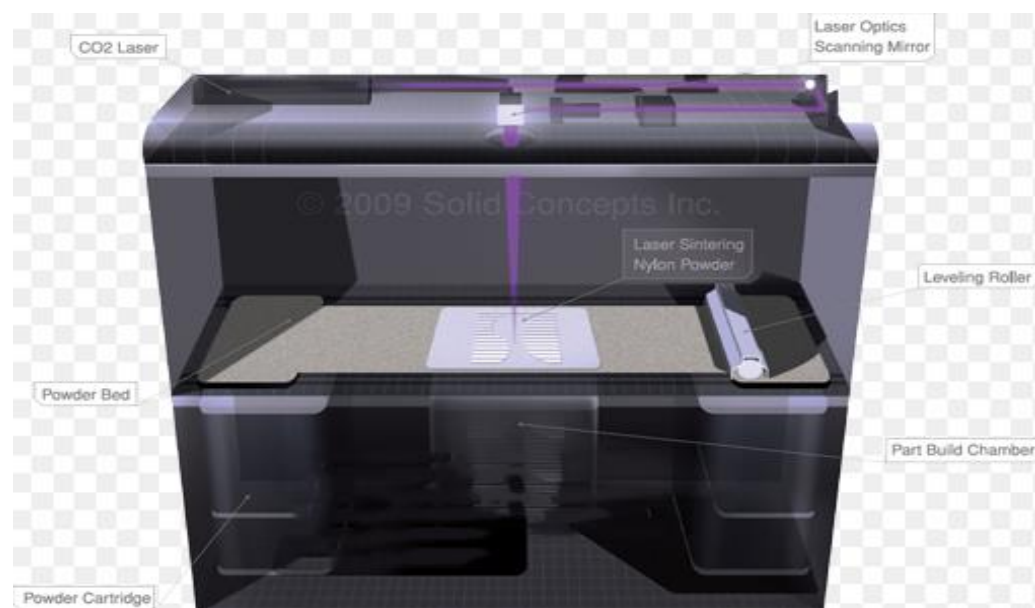

Figure 11. SLS Printer (3dcompare.com).

2.5.2 Multi Jet Fusion

Multi Jet Fusion, commonly referred to as MJF, is a combination between SLS and Material Jetting. Ink nozzles, attached to a movable carriage, secrete binding agent on the build surface where plastic powder is spread. A sintering inhibitor is then applied from another nozzle at the edges of the fused material. Strong InfraRed rays then sinter the cross section where the fusing agent was applied, causing it to solidify, leaving the other areas untouched. HP is the main manufacturer of MJF printers.

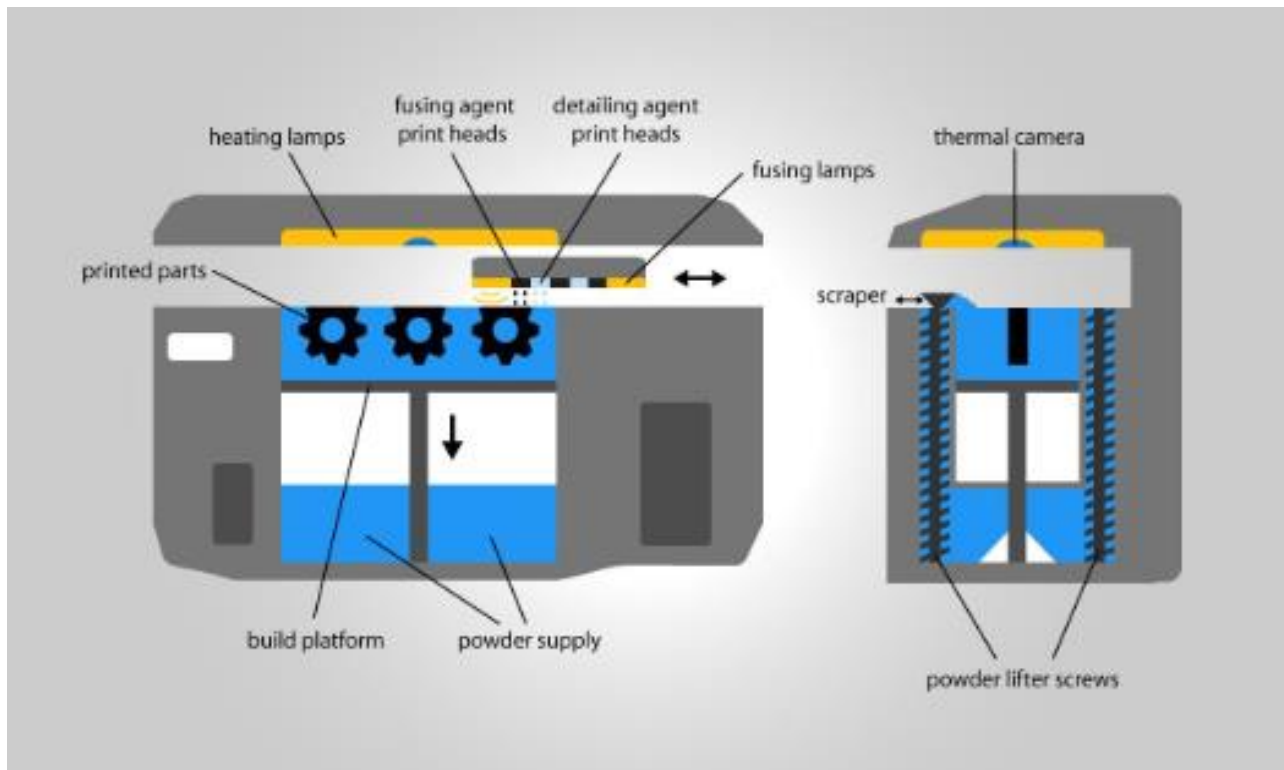

Figure 12. MJF Printer Schematic (tth.com).

2.5.3 Direct Metal Laser Sintering/Selective Laser Melting

SLM and DMLS are Powder Bed Fusion technologies that work in a similar fashion to Selective Laser Sintering technology. The main difference is that a metal powder is used instead of a plastic one. SLM causes the metal powder (single component e.g. Aluminum) to completely liquify (melt), while DMLS causes the metal powder (Alloy) to increase in temperature until it is chemically fused. Support structures are usually needed in order to prevent warping and twisting caused by the metal residual stresses. EOS, based in Munich, Germany, was the first to produce DMLS printers, commercially available since 1995 (Khaing et al, 2001). A couple of competitors have entered the market since then, 3D SYSTEMS and SINTERIT which also produce desktop compatible printers.

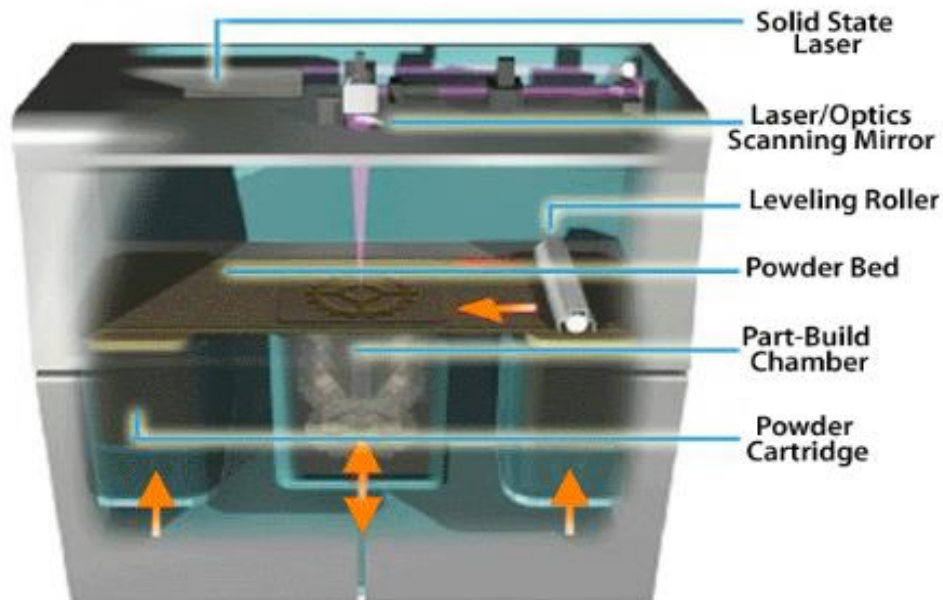

Figure 13. DMLS Machine (lasersintering.com).

2.5.4 Electron Beam Melting

EBM is a technology close to Selective Laser Melting and SLS. An electron beam is directed at the metal powder, causing it to melt, fuse, and solidify according to a traced cross-section. Although EBM is faster than SLM/DMLS and uses much less energy, its end product is of a lower quality. Support structures are not necessarily needed since less residual stresses lead to less deformations. One main drawback of this technology is that the printing system's build surface and powder have to be placed in a vacuum chamber, and only conducting materials can be used. ARCAM patented and is the main manufacturer of EBM technology and printers which use Titanium and Cobalt-Chrome powder. (Sing et al, 2015)

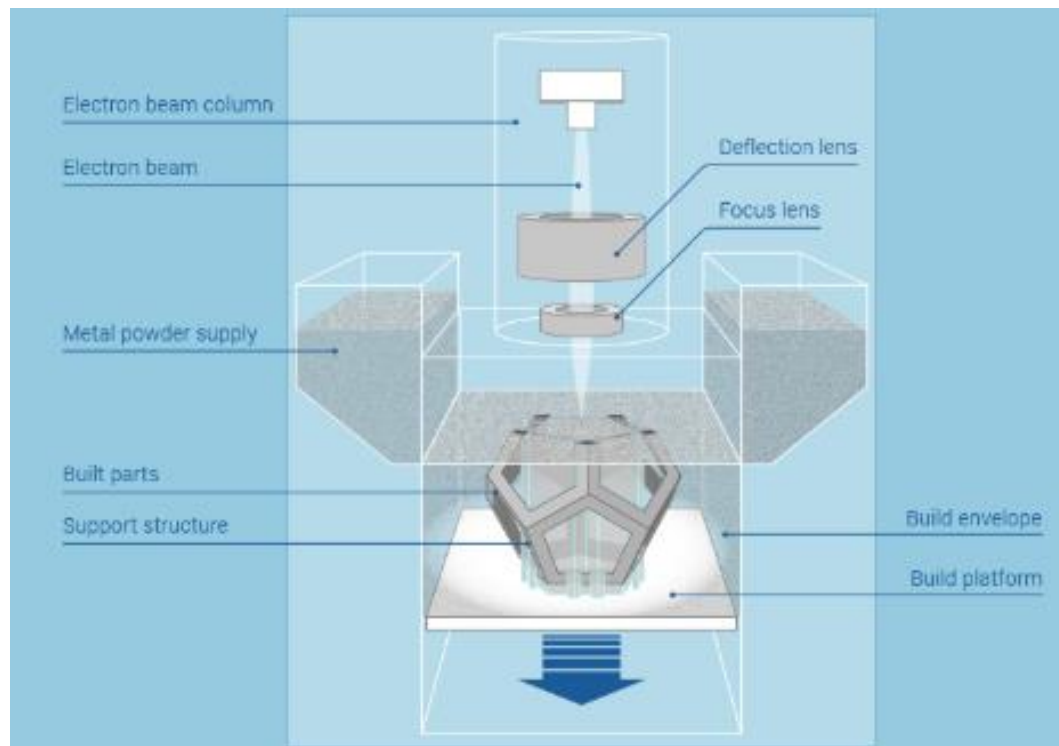

Figure 14. EBM Process (additively.com).

2.6 Directed Energy Deposition

Directed Energy Deposition (DED) is “an additive manufacturing process in which focused thermal energy is used to fuse materials by melting as they are being deposited”. (ASTM, 2013)

2.6.1 Laser Engineering Net Shape

LENS is one of the newest additive technologies. A laser head concentrated at a specific point creates a “melting pool” where a nozzle head and inert gas tubing deposit the powder to be melted and solidified. A metal surface is usually used, and this technique is mostly utilized for repairing by adding material to a certain object (Griffith et al, 1996). OPTOMECH is the main LENS printer manufacturer.

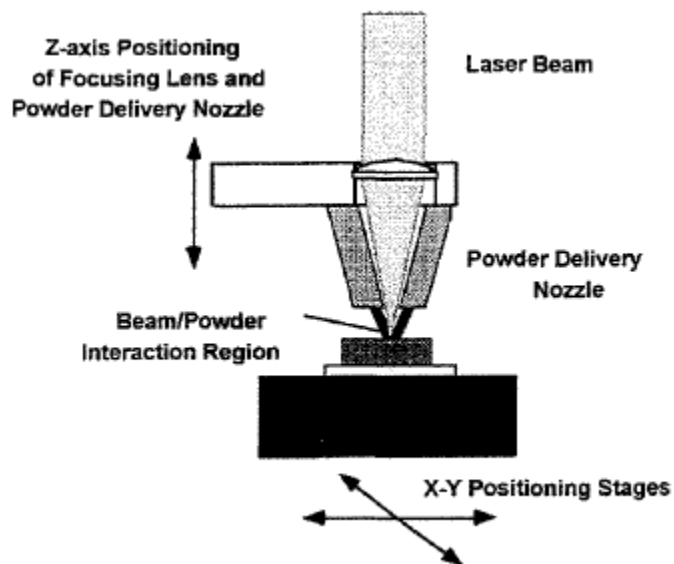

Figure 15. LENS Process Scheme (Griffith et al, 1996).

2.6.2 Electron Beam Additive Manufacturing

A technology originally built for space, EBAM is the second DED printing technique. An electron beam is used as a heat source in order to weld metal wires or powder materials, resulting in a metal end product. Electron beams operate in vacuum and are more efficient than laser beams. The main manufacturer of EBAM printers are SCIAKY INC which utilize titanium, steel, aluminum, or copper.

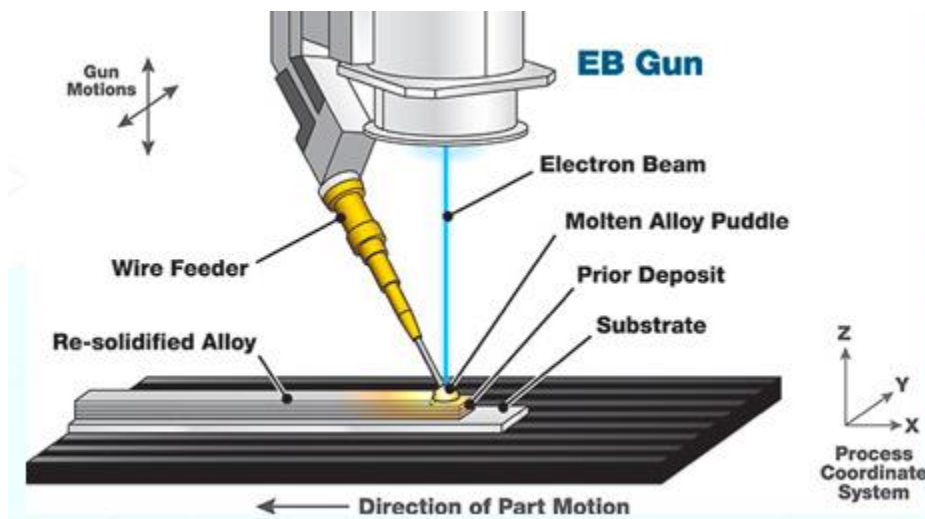

Figure 16. EBAM Process (Sciaky.com).

2.7 Material Extrusion

Material Extrusion (ME) is “an additive manufacturing process in which material is selectively dispensed through a nozzle or orifice.” (ASTM, 2013)

2.7.1 Fused Deposition Modeling (FDM)

Fused Deposition Modeling (FDM), also referred to as Fused Filament Fabrication, is the only ME technology currently in use. Solid thermoplastic material in filament form is heated in the printer nozzle head as it is pushed out in a dense melted form. The printer moves the nozzle according to the desired cross-section, forming layers above layers of solidified material until the final object is obtained. It is the most widely used technology, and concrete printing is based on the same extrusion concept. (Zein et al, 2000).

Most common manufacturers are STRATASYS, ULTIMAKER, MAKERBOT, AND MARKFORGED, which use a variety of materials ranging from nylon and plastic to wood and steel.

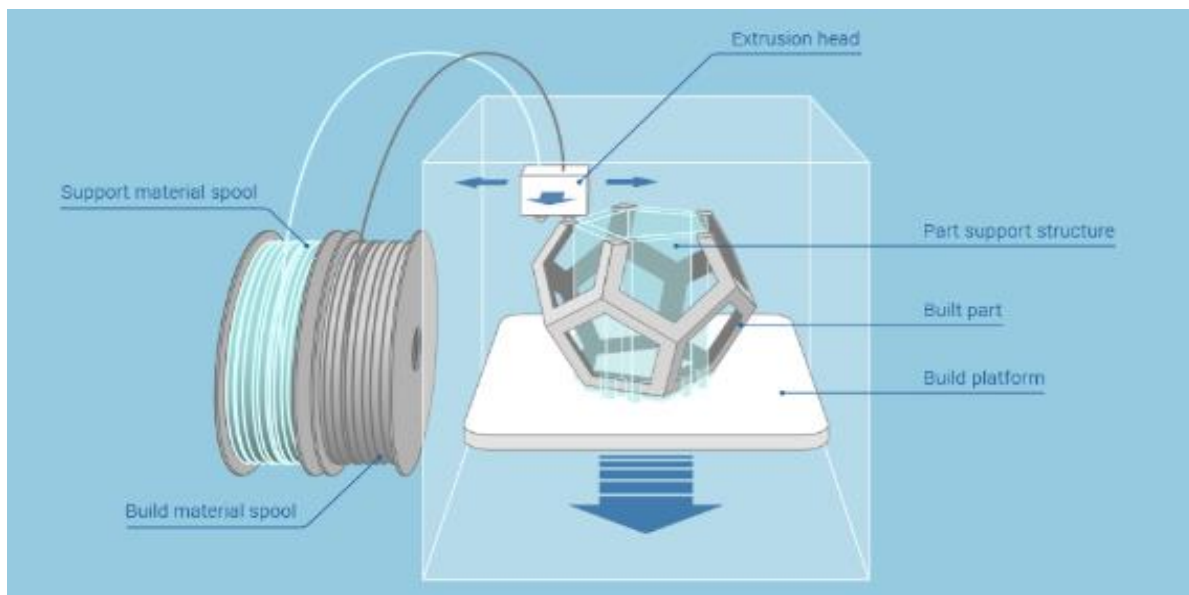

Figure 17. FDM Process Scheme (additively.com).

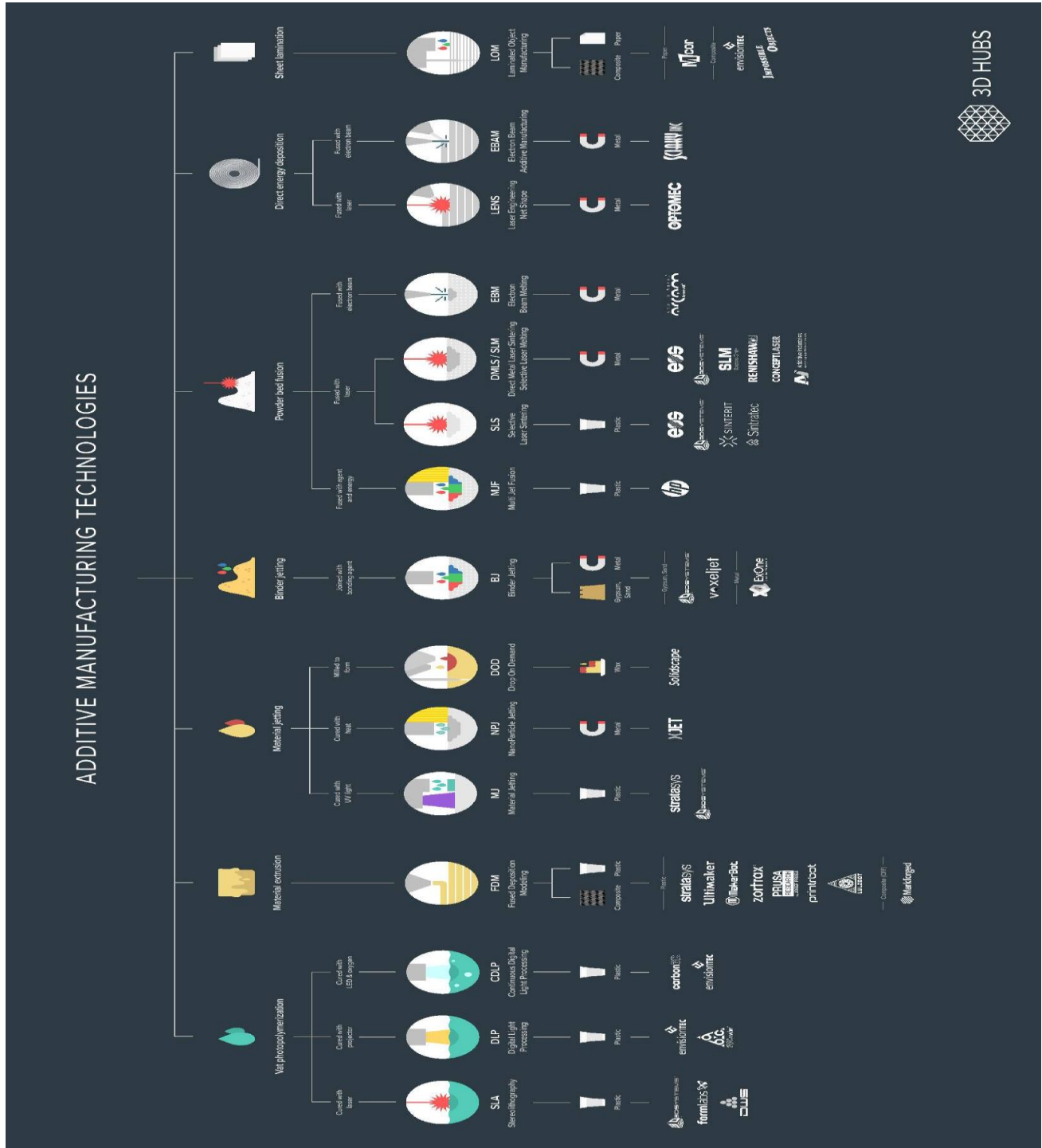

Figure 18. Additive Manufacturing Overview (3dhubs.com).

3. 3D Printing in the Construction Industry:

After the industrial revolution, living standards changed drastically. Robotics is now implemented in a variety of manufacturing applications replacing complicated and possibly dangerous human production activities. This has caused the prices of goods and services to greatly decrease while their quality increases. This however does not apply to the construction industry. (**Khoshnevis, 2004**).

Until today, the construction industry is still heavily labor-oriented, leading to the rise of problems with quality, productivity, safety, and skilled labor (**Hwang and Khoshnevis, 2004**). Several attempts at automation and robotics integration started in the US and Japan, however, they were not very successful since the industry was too dependent on processes not adaptive to automation technologies (**Warszawski and Navon, 1998**). The need for a technology that could accomplish quality, safety, and productivity targets greatly increased in the past decade since it was obvious that the construction industry is lagging behind.

3D printing, an automated layer-by-layer production process, has been adopted for more than two decades in the manufacturing industry. As discussed previously, various 3D printing techniques and methods have been developed, each utilizing different specific materials. Due to their high viscosity and fast melting and solidification properties, plastics, metals, and ceramics have been most widely used. Creating complex models using 3D printing takes just as much time as any other model with no additional cost. This made 3D printing suitable for building complex small-scale architectural models. Consequently, building real large-scale architectural components as well as buildings using additive manufacturing technology have been the main

goals to many companies after years of process evolution and refinement. A few companies have been able to develop and test printers for concrete or concrete-like substances. Years of testing and trial and error are still ahead of us. In the following, different concrete and concrete like substances printers will be discussed, as well as their main operators and manufacturers. It is useful to shed light on the idea that 3D printing works by slicing a 3D Computer Aided Design (CAD) model into layers of 2D models, which are subsequently sent to the printer for construction.



Figure 19. Cheap Housing Using Concrete 3D Printing (theverge.com).

3.1. Contour Crafting

“Contour Crafting Technology adapts Rapid Prototyping capabilities and extends them to the field of large-scale construction.” (Hwang and Khoshnevis, 2004). It is “an additive fabrication technology that uses computer control to exploit the superior surface-forming capability of troweling in order to create a smooth and accurate planar and free from surfaces out of extruded materials” (Zhang and Khoshnevis, 2013). Developed in 1998 at the University of Southern California, Contour Crafting is a 3D printing technology patented by Behrokh Khoshnevis. It is originally designed in order to print large scale models and usable structures for buildings. The whole design is based on the extrusion of contours and consequent filling inside the printed layers by two different nozzles as can be seen in the figure below.

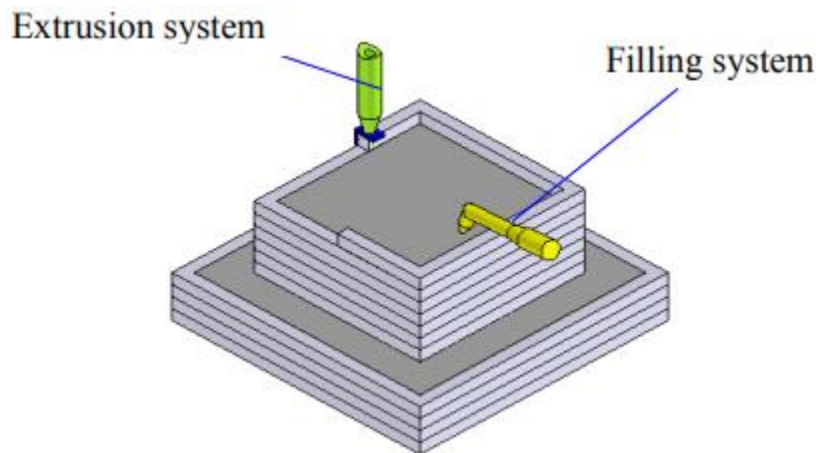
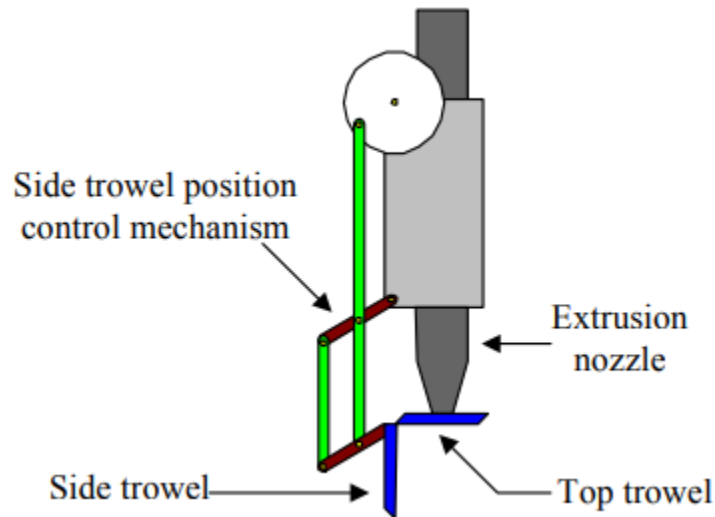

Figure 20. Extrusion and Filling Mechanisms (Hwang and Khoshnevis, 2005).

A smooth object surface is obtained through the extrusion process, where the flow is constrained horizontally and vertically by trowels. The side trowel orientation can be conveniently changed dynamically in order to get a better surface fit of different layers. The side trowel also determines material thickness and allows for thick material decomposition, leading to a much faster process, especially important for building big structures. The outer and top surfaces of outer edges are

first created through the extrusion process. The smoothness of each layer is guaranteed by the top and side operating trowels.



Figure

21. Single Nozzle with Trowels Assembly (**Hwang and Khoshnevis, 2005**).

The surface finish quality of the printed object is determined by the troweled external surface of each layer. It is important however to also have a smooth top surface for better material bonding and layer addition. The last layer top troweling determines its finish. After the boundaries are created, the extruded object can then be filled with a mortar mix as shown in the figure below.

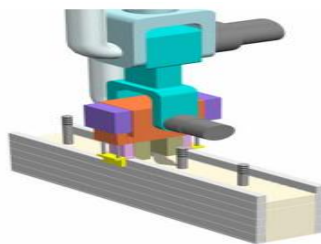

Figure 22.

Material Filling Using a Multiple Nozzle System (**Hwang and Khoshnevis, 2005**).

Materials used in Contour Crafting range from polymers to ceramic slurries and cement. One of the most interesting characteristics of Contour Crafting is that materials with larger aggregates and reinforcements could be printed (**Khoshnevis, Hwang, Yao, & Yeh, 2006**). This could be key to producing fiber reinforced 3D concrete structures using the Contour Crafting printer. The nozzle may have single or multiple outlets, enabling the printer to work on several sections at the same time. By deflecting the nozzle, non-orthogonal surfaces such as domes and vaults can be created (**Khoshnevis, 2004**).



Figure 23. Multiple Outlet CC Printer Model (**contourcrafting.org, 2014**).

The aim of the research done at the University of Southern California (Khoshnevis, 2004) was to first create a single CC printed residence structure in one go. “A gantry system carries the nozzle system and robotic arms move on two parallel lanes on the construction site. Adding an additional support-beam picking and positioning arm could produce conventional structures (at openings). Integrating automatic embedment of reinforcement is studied as well.” (**Wolfs, 2015**). The research then proceeds to the next phase where complete buildings could be realized by

automated systems for plumbing, electrical and communication wiring, beam installation, and painting and tiling. The last phase aims at making Contour Crafting the main process for construction, providing active feedback through its sensory systems and information technologies. Before reaching this stage, many obstacles have to be overcome. The CC printer has a lot of limitations, some of which include (**Zhang and Khoshnevis, 2013**):

- An optimized tool path is required as input in order to get the most out of the technology.
- During construction, each nozzle has to completely finish a layer before moving to the next, which imposes some time and material limitations.
- For multi nozzle systems, collision between printer nozzles has to be avoided.
- Subsequent constraints imposed by layer adherence properties, solidification properties, slump, and support ability of lower layers.

“A tool path of Contour Crafting for a specific structure must describe the position, orientation, velocity, and deposition rate of the nozzle in the entire construction period. This information is converted into a sequence of machine tasks and then fed to the Contour Crafting machine.” (**2013**). This is done after slicing a 3D CAD model into a sequence of 2D layers, as can be seen in the figure below.

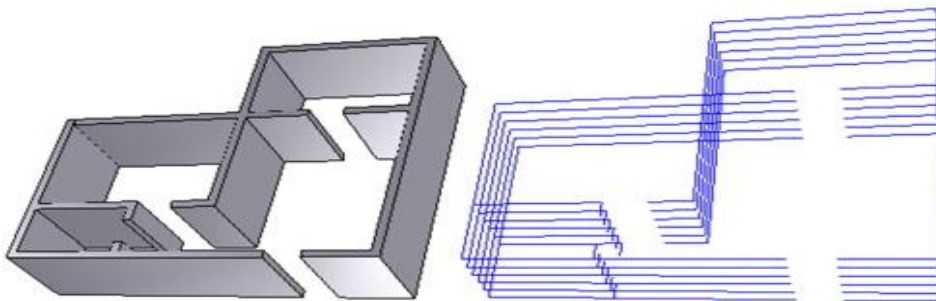

Figure 24. 2D Slicing (**2013**).

The 2D model is then fed to the CC printer, along with the required parameters. The printer's main structure then supports and guides the extrusion system throughout the whole process.



Figure 25. CC printed Structures and Machine (top right) (Lim et al, 2011).

With the possible use of Sulphur concrete and sintered moon soil (aka Regolith) as a printing mixture, NASA has funded Contour Crafting research for its use as a Lunar Construction Method. Human intervention would be minimized, leaving less margin for errors and better safety measures. (Khoshnevis & Zhang, 2012).

3.2.D-Shape:

Based on Z-Corp's Binder Jetting 3D printing process, Dini (2006) proposed "a method for automatically producing a conglomerate structure and apparatus therefor". In other words, he aimed at producing larger scale objects, eventually buildings, by spraying binding material (e.g. epoxy resin, cross-linking polyurethane) on a granular material bed (Dini patent, 2006). By further improving his Monolite process, Dini developed what is known as D-Shape 3D printing. A layer of sand-like material with predetermined hardening properties is laid on the build surface and compacted to the desired layer thickness. Multiple nozzles (300) are then moved around by the printer arm, releasing binder material according to the desired cross-section, hardening the layer of grains below it. The build surface is then moved along the vertical axis, releasing an added layer of granular material, and repeating the same process until the final object is achieved. The maximum current printer size is 6m*6m*6m.



Figure

26. 5m*5m*5m D-Shape Printer (Krassenstein, 2014).

Although there is no specific reason as to why D-Shape has not been employed on-site, it is considered a gantry based off-site dry manufacturing process. Being a powder-based process, the unconsolidated material is used for supporting overhangs and “freedom” features (**CITATION**).

After experiencing problems with the first epoxy resin characteristics, a Magnesium based adherent was developed that solidifies sand, giving it suitable properties.

Architectural pieces of around 1.6m high and sculptures (shown below) were first produced using this technology.



Figure 27. D-Shape printed Sculptures (**d-shape.com**).

Binder deposition rate is one of the main factors affecting printing speed. In addition to this, layer thickness, which varies between 4 and 6mm, is another major contributing factor to printing speed. Since printing is done in a “pool” of sand, the final object has to be retrieved or dug out of the powder bed. This property in particular poses one of the main problems for D-Shape 3D printing, a large volume of material has to be deposited in the build area, and

very large structures could not be realized (**Lim et al, 2011?**). It is also worthy to note that maximum object size cannot be larger than the printer (6*6*6 m currently). Nevertheless, a small complete house (depicted below) was printed in one go using the D-Shape printer.



Figure

28. D-Shape Printed House (d-shape.com).

As can be seen in the above picture, D-Shape printing finish requires grinding and polishing if a smooth surface is desired (**CITE**). Other issues with the D-Shape printing technology relates to the binder penetration through each layer, as well as “bleeding” that could happen next to sprayed areas (dripping adherent material). ESA, a space administration agency, has also expressed interest and funded D-Shape technology for its possible use to build outpost structures on the moon.

3.3.3D Concrete Printing:

Inspired by advances in 3D printing technology, a novel printing process was developed at Loughborough University called Concrete Printing. Concrete Printing, like Contour Crafting, is an extrusion-based 3D printing technique, with a viable future in the construction industry. The main difference is that while CC extrudes a mold and then fills it with concrete, CP is a mold-free extrusion process (**Lim et al, 2011**). As the previous 3D printing processes, the first step in Concrete Printing is providing the printer with a layered representation of a 3D CAD model. Nozzle position, movement, and material flow are all predetermined and fed to the printer with the layered model. The first prototype printer consists of a 5.4m by 4.4m by 5.4m frame “and a printing head on a mobile horizontal-beam which moves in the y and z direction while the printing head moves in the x direction only.” (**Lim et al, 2009**).



Figure 29. Concrete Printing Machine (**Lim et al, 2011**).

The printing process consists of three main stages, being: material preparation, delivering, and printing. Materials based on cement and concrete have been used for the prototype

modeling due to their known properties. The former is used for build material, while the latter is used to create dissolvable or removable structural supports during printing. Constant workability and control of materials are of essential importance during the printing process. Not many details have been provided about the types of mixes used, however, according to **Lim et al (2012)**, workability consistency is provided by a retarder admixture. It is further mentioned that the material mix consists of 54% ash, 36% reactive cementitious compounds, and 10% water by mass (**Lim et al, 2012**). According to **Le et al (2011)**, the binder material is a mix of CEM 1 cement, fly-ash, and undensified silica fume. Shrinkage and deformation in the plastic state are reduced by the inclusion of polypropylene micro-fibers (**Bos, Wolf, Ahmed, and Salet, 2016**). Due to the possible formation of voids during printing, material strength is reduced by around 20% (**Lim et al., 2011**).

Materials are fed to the printer in small batches since it is important to maintain freshness and maximize material strength. In addition to this, the delivery path should also be as short as possible in order to guarantee workability of printed material. After mixing the material, it is shortly stored in a “pump located outside of the rig to deliver material to the nozzle through a hose. A small hopper is installed as a buffer zone on the top of the deposition device which in turn delivers the materials to the desired location. In the beginning of printing, the head is located in the recharging position to fill the materials into the hopper. When the amount of material in the hopper is reached to the pre-defined low level, then the printing head moves back to the recharging position to refill the hopper.” (**Lim et al, 2011**).

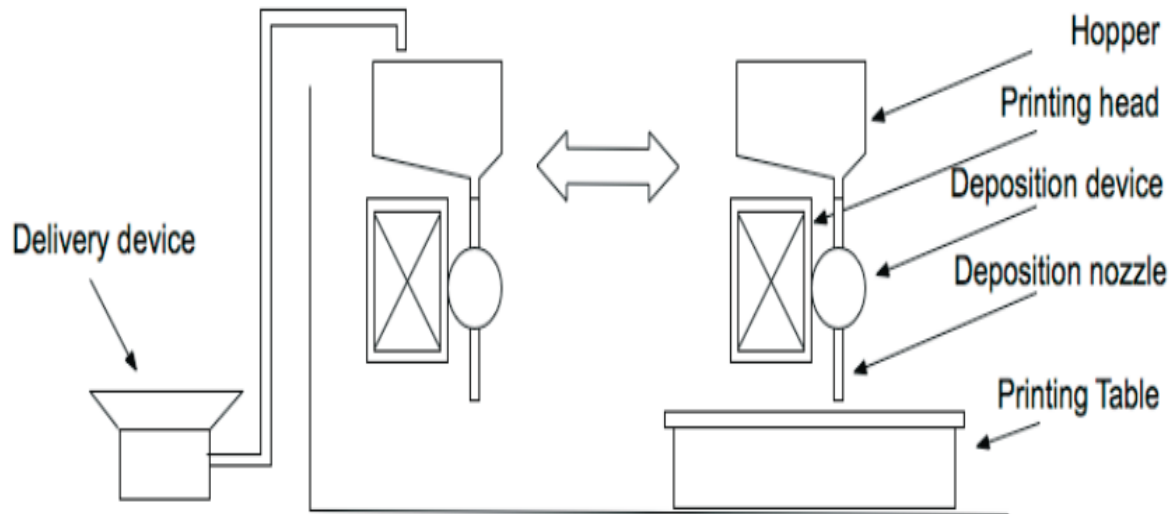

Figure 30. Delivery and Refill Processes (Lim et al., 2011).

A specific tool path, as well as other parameters such as flow rate and movement speed are predetermined. In the first trials, a flow rate of around 1.4 Kg/min was used to accommodate the small nozzle diameter (9mm). Print direction and strength are relatively independent due to the crystallization process through which cement hydrates. Nevertheless, this also means that there is a limited time during which concrete should be printed, before it sets. “The critical issue is the consistent rheology of the fresh material to enable it to move smoothly through each part of the delivery process, yet retain sufficient rigidity once it leaves the nozzle.” (Lim et al, 2011).

Concrete mix has to flow enough in order to exit the printer nozzle, however, it must also be able to withstand the forces exerted by upper layers when wet with minimal slump, and different higher exerted forces when dry. Several objects were successfully printed using this 3D technology, initially using gypsum-based material. These served as test objects for calibrating nozzle size, print speed, and surface finish. It was observed that decreasing the bead size would increase the printing resolution. After a few modifications, the following objects were printed.



Figure 31. 3D Printed Silo (Lim et al, 2011) Figure 32. 3D Printed Bed (Lim et al, 2011).

The first notable structure made using 3D Concrete Printing is Loughborough University's wonder bench, seen in the picture below.



Figure 33. "Wonder Bench" (Lim et al, 2012).

3.4. YingChuang:

Founded in July 2003, YingChuang Building Technique is the first industrial company to successfully 3D print houses around the world. Large scale building components are built at high speed inside their factories, and later moved on site. Their printing technique is similar to Contour Crafting, where inner and outer leaves are printed, with a zig-zagged shape in between. Reinforcement is added during the printing process between layers as observed in the figure below.



Figure 34. YingChuang 3D Printing Technology (winsun3d.com).

A 150 by 10 by 6.6 m printer was developed, along with several possible printable mixes. Glass reinforced gypsum (GRG) was the first patented product by its father company Winsun in 2002, used for 3D printing internal decoration of theaters, stadiums, and offices. The second patented

material was fiber reinforced plastic (FRP), used to 3D print furniture. Special Reinforced Concrete (SRC), also patented by the company in 2006, is used for building internal and external parts of personalized buildings. Floors, walls, and roofs of building may also be 3D printed using the most recently patented (2007) Crazy magic stone (CMS). Multiple houses, a five-story apartment block, and a 1,100m² mansion were realized by YingChuang from 2008 to 2014.

3.5. HuaShang Tengda:

A major competitor for YingChuang on the Chinese market is construction company HuaShang Tengda. After years of developing their 3D concrete printer, HuaShang Tengda was able to build a 2-story 400m² house, completely 3D printed. Their technique differs from others in that the frame of the house, complete with the rebar support and plumbing pipes, is first erected. The machine with a fork-shaped extruder then lays C30 concrete on both sides of the structural element, encasing it within the walls. It took 45 days to completely finish building the 2-story house shown in the picture below.



Figure 35. Two-story 3D printed house (**3dprint.com**).

3.6. TotalKustom:

Andrey Rudenko, a contractor from Minnesota, was able to build a 3D printer which uses a technique similar to Contour Crafting. Main difference between the two methods is that Rudenko uses much less layer height (5mm), which, although slows down the printing process, could result in more detailed structures with better finish. According to Rudenko, cheap, fast, building is not the main concern, contrary to the previously introduced Chinese companies, but being able to completely automate the building process from all aspects (e.g. plumbing, insulation, electrical wiring...) using 3D printing is. No details about the concrete mix used is available, however, a miniature castle in Rudenko's backyard, and a hotel suite in the Philippines were successfully 3D printed by Andrey Rudenko and his team. The abovementioned structures are depicted in the images below. (TotalKustom.com)



Figure 36. 3D Printed Suite (**totalkustom.com**).



Figure 37. 3D Printed Miniature Castle

(**totalkustom.com**)

Several other companies have also had some successful 3D printing initiatives, such as CyBe Additive Industries which is based in Netherlands and developed a mortar reaching bearable strengths within minutes to use for CC (**Anderson, 2015**).

BetAbram, a Slovenian company, successfully 3D printed a concrete staircase, and are further developing their printers for commercial use and availability. They are also working on 3D printable concrete mixtures, although additional mix information is not provided (**Alec, 2014**). A subgroup of Rael San Fratello Architects known as Emerging Objects have developed a printing technique similar to Dini's D-Shape using a fiber-reinforced concrete mixture. It is made up of small aggregates, in addition to the cement and reinforcement, with a variety of adhesives that improve workability. An alcohol-based water-soluble binder is first applied to the dry bed of mix. The synthetic polymer contributes to the mix's adhesive and mixing abilities, while providing it with high tensile capacity. Additionally, it aids the curing phase in terms of speed, and it increases the density of the mixture, causing added flexural strength. Hydration of the material and better connection between the fibers and cement mix is achieved by adding a secondary binder. The obtained hybrid concrete polymer is shown in the pictures below:



Figure 38. Earthquake Resisting Quake Column
(emergingobjects.com)

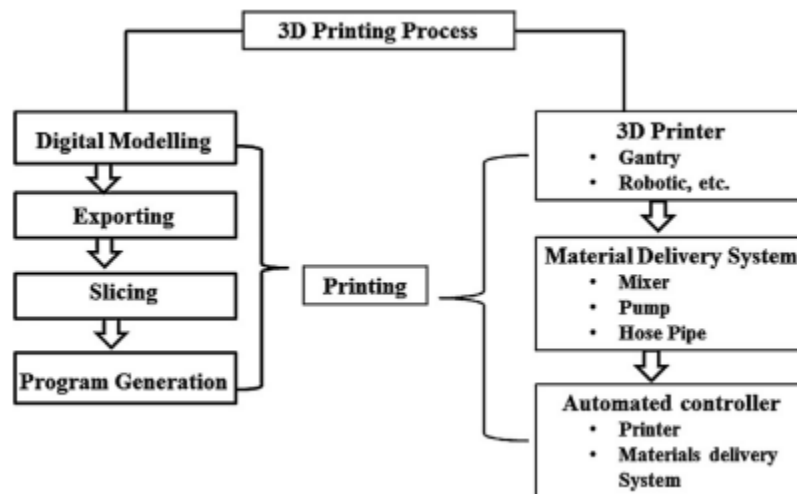

Figure 39. Water Absorbing “Cool Brick”.
(emergingobjects.com)

Similar to D-Shape, the unused dry powder acts as a supporting structure during the printing process and the structure has to be removed from the powder bed. The material used is completely recyclable, however, accurate information about its composition is not available.

4. Printable Concrete Characteristics:

“The emphasis on reduction of construction time and production costs has profound influence on construction process that has led researchers to explore 3D concrete printing.” (Van Zijl et al, 2016). Concrete 3D printing has experienced a lot of advancements in the past decade, with more research and efforts being put into perfecting this technology.



Figure

40. 3D Printing Process (Paul et al, 2017).

Formwork-free 3D printing provides a big level of freedom in structural geometry design, and reduces formwork costs and construction duration. These factors, in addition to the fact that less labor would be needed, would lead to huge savings economically (Nerella et al, 2016).

3 main techniques have been successfully developed and tested for building large-scale building components and structural elements. The abovementioned extrusion-based techniques which are Khoshnevis' Contour Crafting and Loughborough University's Concrete 3D Printing, and selective binding techniques such as Dini's D-Shape, have been discussed in the previous section. The main obstacles of 3D concrete printing are developing a suitable automated printer with optimal nozzle diameters and printing speeds, as well as developing a suitable concrete or more efficiently a mortar mix (since large aggregates $>4\text{mm}$ are not used). Most advances and patents in this field were made in China and the United States, where the private sector is the most advanced when it comes to 3D printing. Due to this reason, concrete mix specifications are not made public, and few indications about their composition are given. Research at a number of universities namely the University of South California (US), Loughborough University (UK), and Eindhoven University of Technology (Netherlands), have cultivated some interesting usable results concerning different concrete mix compositions and early stage characteristics.

While striving for the perfect concrete mix, some important conditions and limitations have to be kept in mind (Nerella et al, 2016):

- Consistency Retainment for longer periods of time;
- Pumpability;
- Extrudability and Buildability (ability to withhold form geometry under pressure from upper layers);
- Setting time;

- Compressive, tensile and flexural strengths in parallel as well as perpendicular directions to layer-interface-plane;

Consistency of concrete is defined as the ability of concrete to flow. Concrete consistency is measured by means of the slump test which measures the ability of concrete to start flowing (Kosmatka et al, year). A metal cone, open from both sides is placed on a horizontal surface, concrete is then place inside, and the cone swiftly removed. The time concrete takes in order to “slump” or fall a specific vertical distance is then measured (Ferraris, 1999).

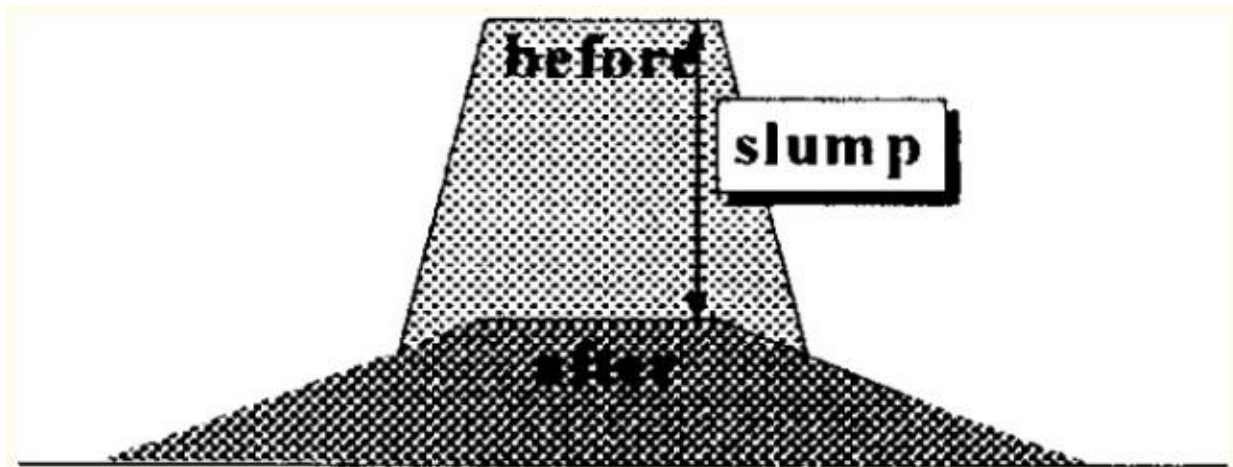

Figure 41. Slump Test Representation (Ferraris, 1999).

When it comes to layer-by-layer concrete placement, a low slump is required in order for layers to maintain their shape and thickness throughout the printing process. As slump decreases, hydration of concrete is allowed to take more time, however, if the hydration process of concrete is fast, a larger slump could be allowed. Pumpability, which is related to the speed of hydration of concrete, is the ability of concrete to be pumped out of the printer nozzle. Mixes with very low water to cement ratios set faster and are stickier, making them more convenient to hold as layers, but also nearly impossible to pump from a printer nozzle (Paul et al, 2017).

Keeping in mind the importance of pumpability, concrete printed in the form of layers has to be able to withstand pressure from higher layers and form a good connection between them. A high water to cement ratio would cause the concrete to slump, therefore additives which guarantee workability with a low slump and high early strength are needed (Feng et al, 2015).

Setting time is defined as the time needed for concrete to pass from a liquid phase to a solid phase and gain its full mechanical strength. Printable concrete comes out in a dough-like fashion, and needs to set fast enough for the concrete to gain strength in order to withstand layer addition, but also slow enough in order to guarantee a connection between different layers.

“One of the main disadvantages of printed structures is their mixed isotropic and anisotropic properties in different direction unlike cast specimens that is taken to have isotropic properties in all directions.” According to Paul and colleagues (2017), printing direction and time gap between printing layers are important factors in developing the load bearing capacity of an object.

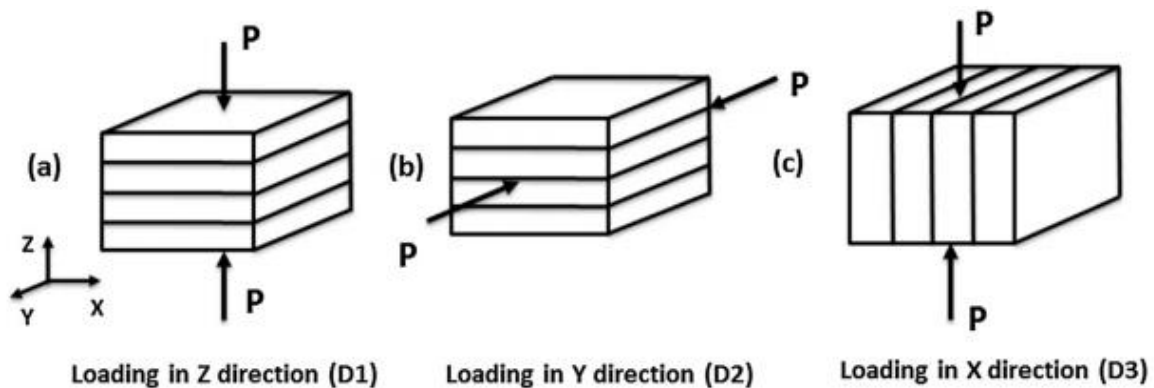

Figure 42. Force Direction (Nerella et al, 2016).

Tests done by Nerella and colleagues (2016) show that better compression strength is obtained along the D1 and D3 direction in layer based extruded concrete than in mold-cast concrete. An

increase of 10% is obtained along D1 direction, and an increase in 14% is observed along the D3 direction (2016).

Similarly, flexural tests done by Nerella and colleagues (2016) show that an increased flexural resistance of 16% along D1 and 14% along D3 is observed in printed concrete compared to mold cast concrete.

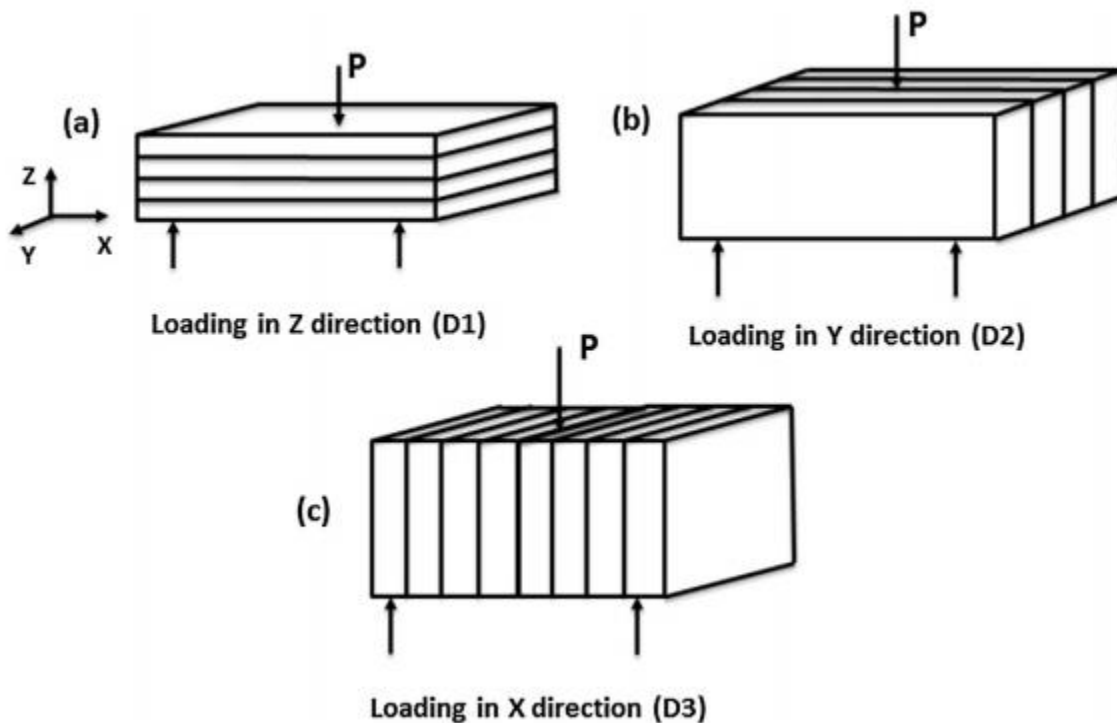

Figure 43. Flexural Test Loading (2016).

In similar tests, Feng and colleagues (2015) obtained higher compression resistance along the parallel direction (D1) than along the perpendicular directions (D2 & D3).

The tensile strength along the D1 (z-axis) direction depends on the bond strength between the layers of concrete.

These results however may vary from batch to batch and from one position to the other. Since hydration is a continuous process in time, concrete becomes harder to extrude as it reaches its setting stage. Freshly mixed concrete used for bottom layers is still in a convenient plastic phase for extrusion. In addition, “the hardening properties of concrete may differ significantly if concrete is disturbed after its plastic phase.” (Paul et al, 2017).

Loughborough University’s lab conducted some tests on samples collected from the printed concrete wall and a slab using the 3d Concrete Printing technology, and compared it to mold-cast concrete. Regarding the wall, the compressive strength of mold-cast specimen (107 MPa) was 30% higher than the printed wall. However, the printed slabs showed a 5-15% loss of compressive strength compared to the mold-cast concrete (91-102 MPa). These results varied with the orientation of the load, depending on the orientation of the printed layers, having the lowest strength value when the load is applied parallel to the layers (Le et al, 2011).

Unlike in compression, printed specimen showed an increase in flexural strength compared to the mold-cast ones when bottom tension was in alignment with the printed filaments. Values ranging between 13 and 16 MPa were obtained for the printed concrete, compared to the 11 MPa obtained from mold-cast samples. Unsurprisingly, flexural strength greatly decreased (up to 36%) when the tests were done using a load perpendicular to the layers, as compared to a mold-cast subject (7 MPa). The increase in flexural strength when the loading is aligned with the layers is due to the fact that the bottom layers of concrete are more compacted, and could withstand more tension (Le et al, 2011).

Tensile bond strength is another important studied factor, as an adequate bond is required between the layers. Subjects with printing time gap of more than 15 mins did not bond well, and

therefore failed at layer interface, whereas subjects printed within that time lapse had adequate bond strength and experienced a material failure (**Le et al, 2011**).

Due to the abovementioned conditions and limitations, fresh printed concrete rheology is of essential importance for the success of the process. Rheology is defined as the study of the flow of “soft solids” and plastic like material (**Schowalter, 1978**), like concrete in its early stages.

According to **Kosmatka and colleagues (1994)**, three main terms are significant when dealing with concrete rheology; workability, consistency, and plasticity. “Workability is a measure of how easy or difficult it is to place, consolidate, and finish concrete; Consistency is the ability of freshly mixed concrete to flow; and Plasticity determines concrete’s ease of molding”

(**Schowalter, 1978**).

5. Mix Designs:

Based on the abovementioned properties and characteristics of concrete, different concrete mix designs were developed in different labs.

The Contour Crafting mix was developed at the University of Southern California after several trial and error experimentation. The following mix was achieved:

- Type II Hydraulic Portland Cement	37%
- Sand	41%
- Water	19%
- Plasticizer	3%

Experiments show that this mix results in a mean compressive strength of 18.9 MPa. Fine aggregates (sand) are utilized in order to accommodate for the small nozzle diameter and add strength to the mix, while a superplasticizer is used to increase the workability of the mix (**Hwang and Khoshnevis, 2005**). No additional information is available about the concrete mix used in order to fill the CC “molds” and specifics.

Other cement-based mixes are particularly used in the Concrete 3D Printing technology.

Loughborough University’s lab developed and tested several concrete mixes, suitable for high printing resolution. Five mixes were tried, shown in the table below.

Material	Mix proportions (kg/m ³)				
	Mix 1	Mix 2	Mix 3	Mix 4	Mix 5
Sand	1612	1485	1362	1241	1123
Cement	376	446	513	579	643
Fly ash	107	127	147	165	184
Silica fume	54	64	73	83	92
Water	150	178	205	232	257

Table 1. 3D Concrete Printing Trial Mix Proportions (Le et al., 2011).

Sand with a maximum diameter of 2 mm was added to the binder component made up of cement CEM I 52.5, undensified silica fume, and fly ash. The mixture includes reinforcement consisting of 12/0.18 mm length/diameter polypropylene micro fibers. Mix 4 was found to be the best mix, considering it has the lowest binder content, with the supplier-recommended dosage of 1.2 Kg/m³ of reinforcement. A 1.5 and 0.26 sand-binder and water-binder ratios were used respectively. The mix also contained a superplasticizer with 1% by weight of binder, and a retarder with 0.5% by weight of binder, extending the open usable time up to 100 minutes.

A slightly higher density (2350 Kg/m³) is obtained in the printed subjects than in the mold-cast subjects (2250 Kg/m³) (Le et al, 2011).



Figure 44. Concrete Mix Preparation.

6. Reinforcement in 3D Printable Concrete:

While Portland Cement-based materials exhibit high compressive strength properties, their tensile and flexural strengths are notably less (**Hambach & Volkmer, 2017**). In order to overcome this deficit in traditional construction, reinforcing steel bars are usually used.

Construction codes present the minimum and maximum amounts of reinforcement that should be used in order for the structure to attain a good tensile and flexural capacity, as well as ductility properties pertaining to the recommended mode of failure, and an increased stiffness.

Automation of the construction industry on the other hand, requires a new reinforcement approach that provides structural stability through high strength and ductility (**Panda et al, 2017**).

Various types of reinforcement have been utilized and tested in the current 3D concrete printing industry and laboratories. Chinese company **HuaShang Tengda** “adopts a method of erecting a steel frame on-site and printing around it”, while its rival company **Winsun** has not revealed any particular details regarding the structural role of concrete and its reinforcement, although few pictures suggest that bars of reinforcement may have been used between the printed contours (**Bos et al, 20016**). **Lim and colleagues (2012)** printed the concrete “wonder” bench at Loughborough University by leaving hollow openings over the height of the structure for post-tensioning using prestressed bars fed after printing, ameliorating its tensile and flexural capacity, although the overall ductility of the structure is not enhanced.

Meanwhile in Netherlands, construction company **BAM Infra**, with the help of the Eindhoven University of Technology laboratories, erected the first 3D printed concrete bridge seen below,

open for cyclists and pedestrians. Steel reinforcement was embedded during the printing process, as well as layers of reinforcing steel wires placed above each layer of printed concrete for increased ductility, tensile, and flexural strength.



Figure 45. 3D Printed Pedestrian Bridge – Gemert, Netherlands (**3dprint.com**).

The most currently researched form of reinforcement is fiber reinforcement, being the most efficient and requiring least time for complete automation. Several factors have to be considered, such as nozzle opening diameter, material of reinforcement, maximum reinforcement length and thickness, as well as reinforcement orientation. Carbon, glass, and basalt, in addition to steel and polymer reinforcing fibers have been used by some authors. With a fiber length ranging between 3 and 6mm, and a diameter of 7 up to 20 μm , fiber reinforced products show an increased flexural strength from 10 MPa to 30 MPa. Fiber alignment and orientation are imposed by the

printing path, especially when a nozzle opening diameter smaller than the reinforcement length is used. This leads to enhanced flexural and tensile properties along a specific predetermined direction, making the print path an important aspect to account for (**Hambach & Volkmer, 2017**).

III. Experimental Program

Very few literature articles on 3D printable concrete testing have been published due to the recency of this technology. Most tests are done in private labs by private companies, and therefore their methods and results are not available for the public. Academic papers show results pertaining to tension and compression in addition to shear, however, a specific description of testing apparatus and techniques is not included. Based on Mettler and colleagues' work on Cement and Concrete Research (2016), a concrete testing framework similar to theirs was adopted in the current study. Evolution of strength and failure of SCC during early hydration (**Mettler et al, 2016**) utilizes a set of non-standard mechanical tests in order to distinguish between two regimes in the evolution of self-consolidating concrete strength. "In the first, the material is capable of undergoing large localized plastic deformations, followed by a transition to cohesive frictional material behavior dominated by crack growth" (**Mettler et al, 2016**).

Although the tested concrete is not specific to 3D printing, its use in robotic fabrication techniques makes its early stage properties similar to those of printable concrete concerning rheology and workability, and the tests relevant. Mettler and Colleagues' article (2016) describes 6 test setups namely Penetration (a), Punch-Through (b), Shear (c), Compression (d), Tension (e), and Bending (f). Strength evolution assessment in time was done by tracing the force-displacement curves at different ages since mixing, which results in different hydration states. Failure patterns were then assessed qualitatively, revealing important insight into the behavior of the material at different times since mixing. The different test molds used, as well as their dimensions, are summarized in the following two figures (Mettler et al, 2016).

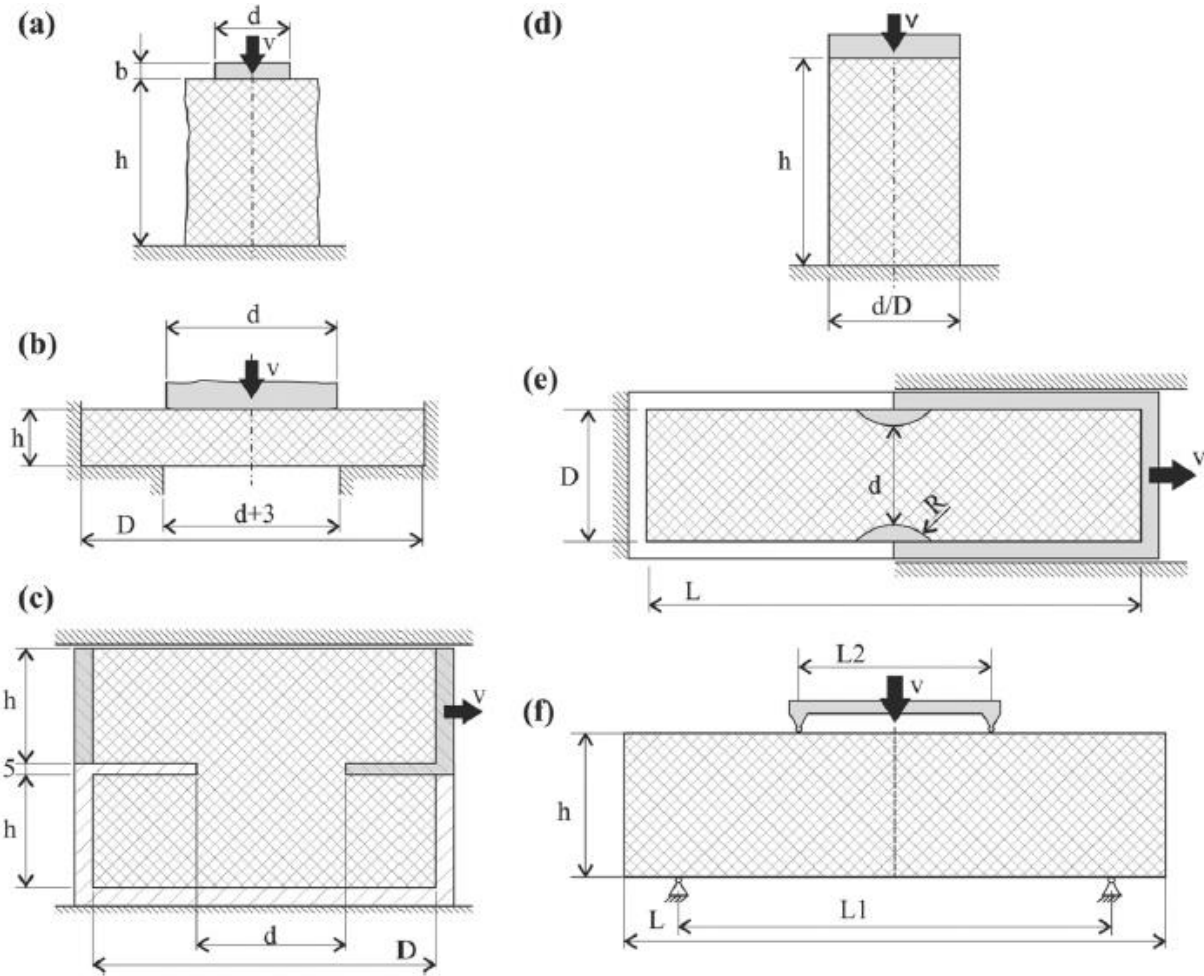

Figure 46. Experimental Testing Setups (Mettler et al, 2016).

	b [mm]	d [mm]	h [mm]	D [mm]	L/L ₁ /L ₂ [mm]	A _{eff} [mm ²]	N
Test (a)	4	18.8	40	-	-	$(d/2)^2 \cdot \pi$	>500
Test (b)	-	60	20	120	-	$d \cdot h \cdot \pi$	50
Test (c)	60*	60	50	150	-	$b \cdot d$	41
Test (d)	-	63	100	63	-	$(d/2)^2 \cdot \pi$	93
Test (e)	-	60 (R = 31)	60*	80	300	$d \cdot h$	43
Test (f)	60*	-	60	-	225/180/80	$2/3 \cdot (b \cdot h^2)/(L_1 - L_2)$	16

Table 2. Mold Dimensions (Mettler et al, 2016).

According to Mettler and Colleagues (2016), shear, compressive, and tensile strengths are represented by the Von Mises criterion in the first principal regime, when the material is ductile. Presented below are the adopted experimental setups, for shear and tension, based on the above presented molds. It is worthy to note that both molds were made from cut and dimensioned transparent plexiglass plates of 10mm thickness. Plates were then assembled and fixed together using steel screws at their designated positions.

1. Shear Apparatus:

Similar to the Jenike Shear Cell (**ASTM D6128-14**), but utilized in a horizontal fashion rather than vertically as described in the article (Mettler et al, 2016), the shear mold used for the current study is made up of two compartments, one horizontally displaced at a constant rate, while the other fixed, measuring its resistance. A steel rod directly translates the horizontal movement of the testing machine to a steel plate fixed in the middle on the mold. Two horizontal plates, each attached to one compartment, “produce a notch for cleaner shear conditions at the fracture plane” (Mettler et al, 2016). Side railings were utilized in order to avoid any unwanted horizontal movement. Seen below are a dimensioned figure of the setup, exported from AutoCAD, and images of the real model.

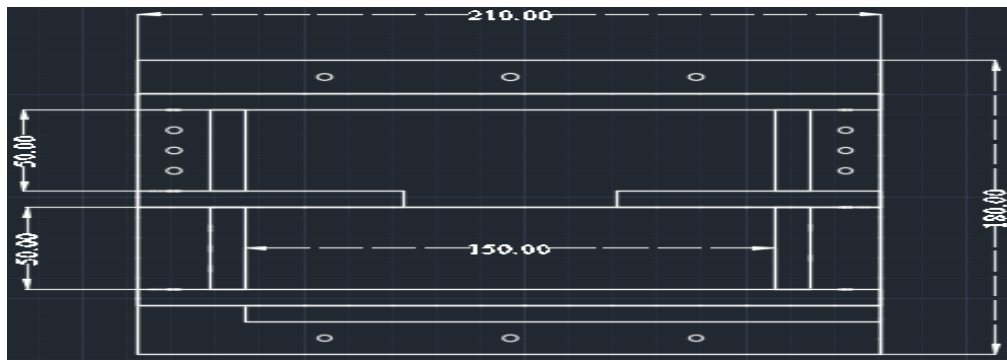

Figure 47. Shear Mold Dimensions (mm) – Taken from AutoCAD 2016



Figure 48. Empty Shear Testing Apparatus

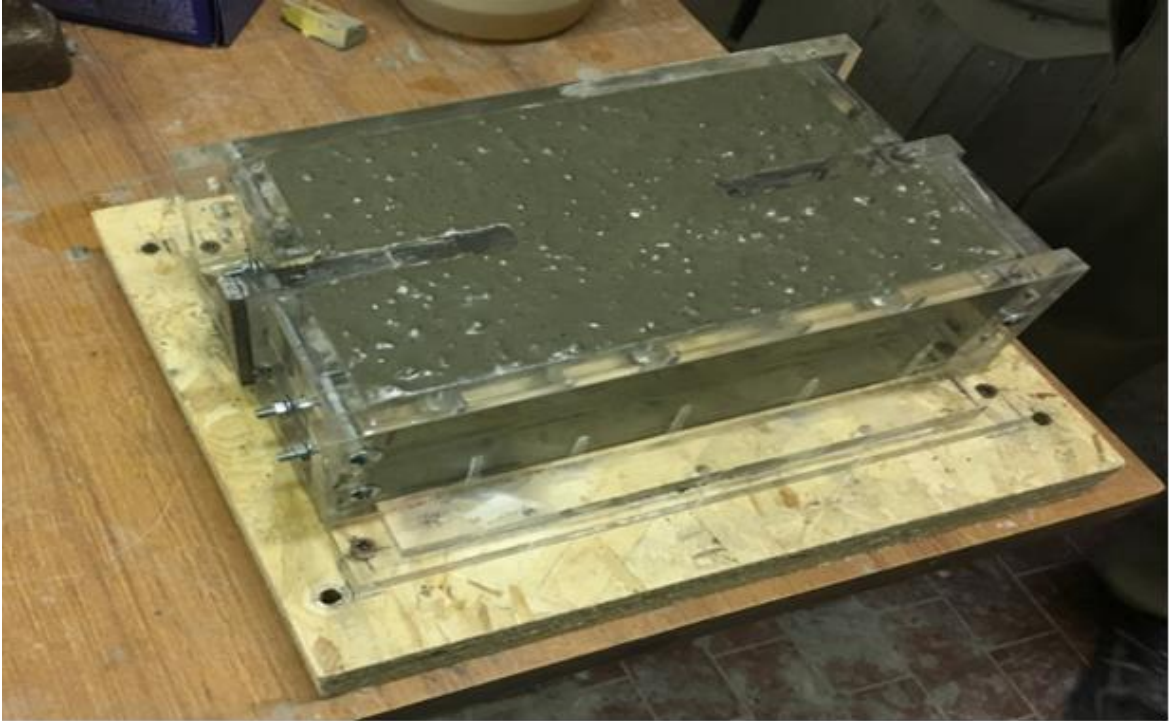

Figure 49. Full Shear Testing Apparatus.

2. Tensile Apparatus:

In the current study, as in the study of Mettler and colleagues' (2016), a mold of two separable parts was utilized for the tensile test implementation. Since fresh concrete cannot be clamped, a lot of “slipping” would result at the contact surface. Two rows and 3 columns of pins were therefore laterally attached to the side of the box in order to enhance shear transmission from the mold to the sample. “A round notch of radius $R = 60$ mm, reduced the effective cross section of the sample to $A_{\text{eff}} = d \cdot h$ with width d and height h .” (Mettler et al, 2016). For practical purposes, two pipes with a diameter of 80mm, cut at a convenient chord location, were fixed to the movable part of the mold using silicon filling. During testing, one half is horizontally separated by clamping the pulling machine to a rod passing in the middle of two plates, each fixed to a side, as observed in the figures below. Two rails on each side ensure the straight movement of one tensile apparatus half, while the other half is fixed to the base plate. The dimensioned picture taken from AutoCAD, as well as pictures of the assembled apparatus are shown below.

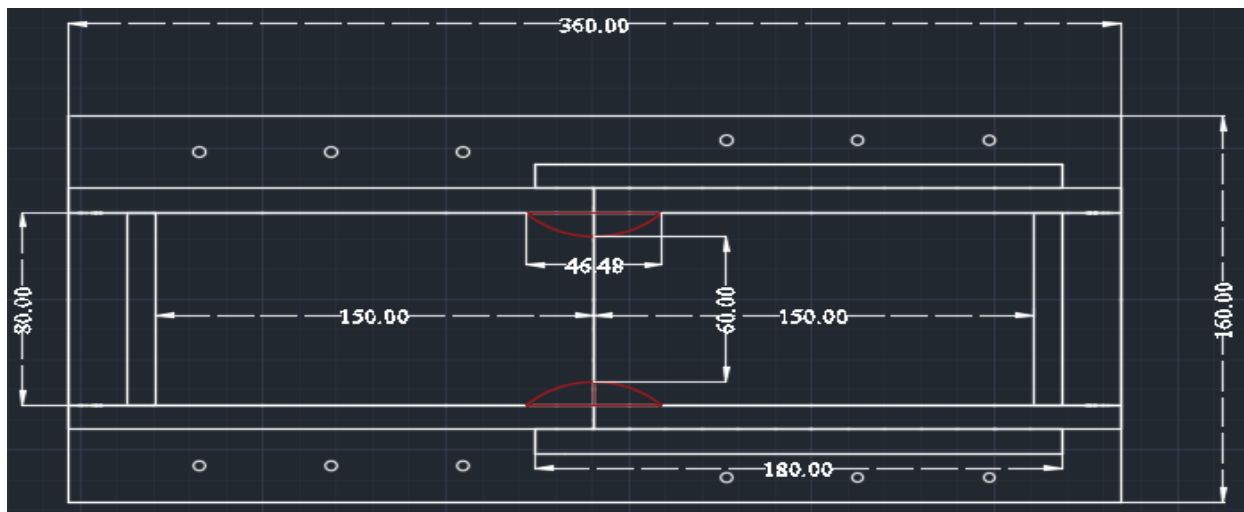

Figure 50. Tensile Mold Dimensions (mm) – Taken from AutoCAD 2016

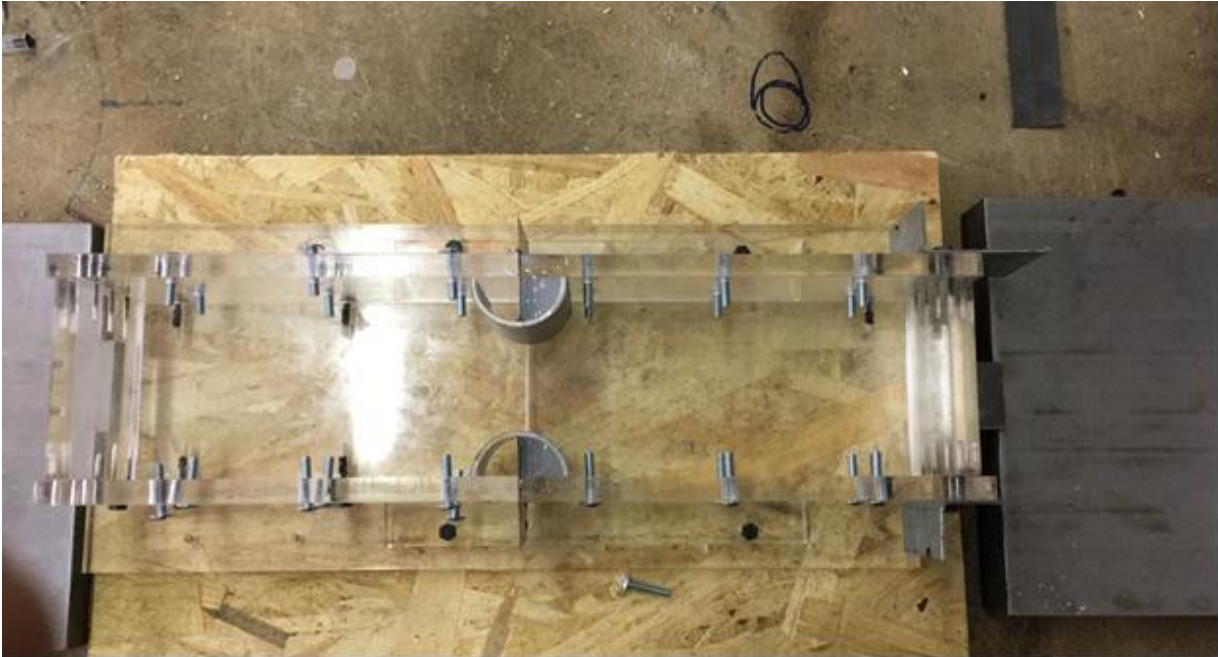

Figure 51. Empty Tensile Testing Apparatus



Figure 52. Full Tensile Testing Apparatus

3. Mix Composition:

Based on literature mixes, two mix designs were utilized for the current study. Having the same composing materials, different quantities and percentages of each material were used for each mix. Materials used are cement, blast furnace slag, sand, superplasticizer, steel reinforcement fibers, and water.

3.1. Cement:

Cement is defined by **ACI (American Concrete Institution) 116R-00** as a binder that sets and hardens by chemical interaction with water. Since this study aims at producing High Strength Cementitious Composites, cement with a compressive strength of 42.5 MPa was used.

3.2. Grounded Blast Furnace Slag (GBFS):

Slag cement, a fine non-metallic product, consists essentially of “silicates and aluminosilicates of calcium and other bases which are developed in a molten condition simultaneously with iron in a blast furnace” (**Slag Cement Association, 2013**). It is used in order to replace a portion of the cement in the concrete mix, with the following measurable improvements according to the Slag Cement Association (2013):

- Better concrete workability
- Easier finishability
- Higher compressive and flexural strengths
- Lower permeability



Figure 53. GBFS (indiamart.com)

- Improved resistance to aggressive chemicals
- More consistent plastic and hardened properties

Since the current study aims at testing the early age characteristics of concrete to be later developed for 3D printing, concrete workability as well as finishability and compressive and flexural strengths are of main concern. Slag is therefore used for this study's cement mix.

3.3. Sand:

In the current study, a high strength cementitious compound is required for testing. As mentioned earlier, the tests are being developed in order to eventually test a suitable mix for 3D printing. To that aim, coarse aggregates cannot be used, especially those bigger than the possible nozzle opening. Fine aggregates (sand), which lead to greater strengths and less shrinkage, are therefore utilized, sieved to obtain a maximum of 2 mm diameter.

3.4. Superplasticizer:

Superplasticizer is an admixture (e.g. material other than water, hydraulic cement, fiber reinforcement and aggregates) which aims at reducing the amount of water used (for better strengths) and increasing flowability (slump) as well as workability, without causing undue set retardation or entrainment of air in mortar or concrete (**ACI 116R-00, 2000**). GLENIUM, a polycarboxylate-ether-polymer-based superplasticizer produced by BASFTM is therefore used.

3.5. Fiber Reinforcement:

The advantages of fiber-reinforcement and its benefits have already been discussed in the literature review. For this study READY MESH MR-200 steel fibers, of 0.22 mm diameter and 20 mm length, provided by AZICHEM, have been used.



Figure 54. Steel Fibers (AZICHEM Ltd)

3.6. Water:

Essential for forming the cement paste, water leads to the hardening of concrete through the hydration process. Water/Cement ratio is one of the most important factors in a concrete mix, and has drastic effects on early strength and workability. Different water/cement ratios were used for the different mixes.

It is important at this point to keep in mind that the concrete mix developed and used for this study is not meant for 3D printing purposes, but close enough (of similar components) in order to assess the reliability of the assumed methodology.

4. Experimental Mix Design:

An excel spreadsheet with the following tables was used in order to obtain the used mix designs.

Data Input		
Rcm_28gg	> 70	MPa
Rcm_1gg	>15	MPa
Consistency S1, slump	0-40	mm
Dmax	4	mm
Cement	CEM_II_42.5R	(-)

ro_cem	3.10	Kg/l
ro_inerti	2.67	Kg/l
ro_SF	1.09	Kg/l
ro_AE	1.03	Kg/l
ro_PP	0.91	Kg/l

Table 3. Data Input.

Mix design per 1 m ³ =1000 l of CLS			PER LITRO	Per 40 L in Kg	% weight
A/C	0.380	(-)	0.380		
Water	203.000	Kg	0.203		
Water with SP	188.790	Kg	0.18879	7.55	0.00
Water with Inert Humidity	175.685	Kg	0.17569	7.03	8.86
Cement	534.211	Kg	0.53421		
Cement with SP	496.816	Kg	0.49682	19.87	22.3%
a'	0.040	%			
a_areante	0.025	%			
V_SF	1.60	l			
V_AE	0.00	l			
V_PP	1.10	l			
Vinerti	583.253	l			
P_TOT_inerti/m³	1557.285	Kg per m³	1.55728		69.8%
Inerte_Tipo 4	0.000	Kg	0	0.00	125.38
Inerte_Tipo 2_Sabbia_Lavata	1456.061	Kg	1.45606	58.24	0.00
Filler	101.223	Kg	0.10122	4.05	0.00
MV		Kg/m ³			
MV_SF	2232.525	Kg/m ³			
Additives					
Fiber in PP	1	Kg	0.00100	0.04000	0.045%
%Superplasticizer Polvere BASF	0.0035	* m_cem	0.00174	0.06955	0.084%

Table 4. Mix Design.

The Following two mix designs presented in table 5 below (by weight) were used:

	Mix 1	Mix
Cement	900 g	990 g
Slag	750 g	825 g
Water	300 ml	330 ml
Superplasticizer	50 ml	55 ml
Sand	1473 g	1620 g
Fibers	180 g	198 g

Table 5. Cementitious Composite Mixes.

5. Mix Protocol:

The mixing process was done in a metal mixing bowl. The cement and slag are first placed in the bowl and mixed for one minute. Water and the superplasticizer are then simultaneously poured, each throughout thirty seconds in the mentioned order. After two minutes have elapsed, sand is added and left to mix for two to three minutes.

At this point, after a total of five minutes have elapsed, reinforcing fibers are added and the mix is left for a total of seven minutes. After the seven minutes, the mixing is finished, the mixing bowl is removed, and concrete is poured into the chosen mold for testing.



Figure 55. Mixing Metal Bowl.

6. Material Testing:

Three different tests were applied: Shear and tensile, whose apparatuses are already described earlier, and slump, which has been explained in section IV.

6.1 Shear Test:

The shear apparatus, already described before, is made up of two interlocking compartments.

One part is free to move along one direction, while the other is fixed. A small steel plate is fixed to the movable edge, in the middle of the system. The mechanical jack is connected to a small segment of an 8 mm rod, which coincides with the center of the system to avoid any rise of unwanted moments, as observed in the figure 56 on the right.

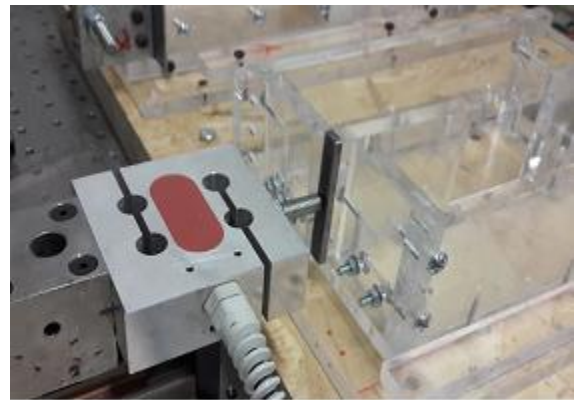

Figure 56. Transducer Push System.

Displacement is measured by means of a transducer (figure 56) whose tip is placed on the other side of the movable part. Seen in the figure 56 below are the mechanical push system, which moves at a speed of 0.1 mm/s causing the displacement, and the transducer on the other end, measuring the shear displacement. The whole system is fixed to the table.



Figure 57. Shear Test.

6.2 Tensile Test:

The tensile apparatus, made up of two parts, has steel plates fixed to the opposite exterior sides of the movable compartment. The steel plates are drilled to the size of an 8 mm rod, passing through the center of the two plates. A spherical joint, previously inserted in the rod so as to be at the middle of its length, and therefore the system's, connects the movable plate to an electromechanical jack. The electromechanical jack is that of a force-exerting machine, controlled through a computer software. The pulling movement exerts a force at the rate of 0.05 mm/s on the movable part of the system, while the other part is fixed. The displacement is then measured by means of a transducer, placed behind one steel plate (moving with the system), whose signal is sent to the computer software for analysis. Shown in the figure 58 below are the electromechanical jack and the transducer, fixed to the table.

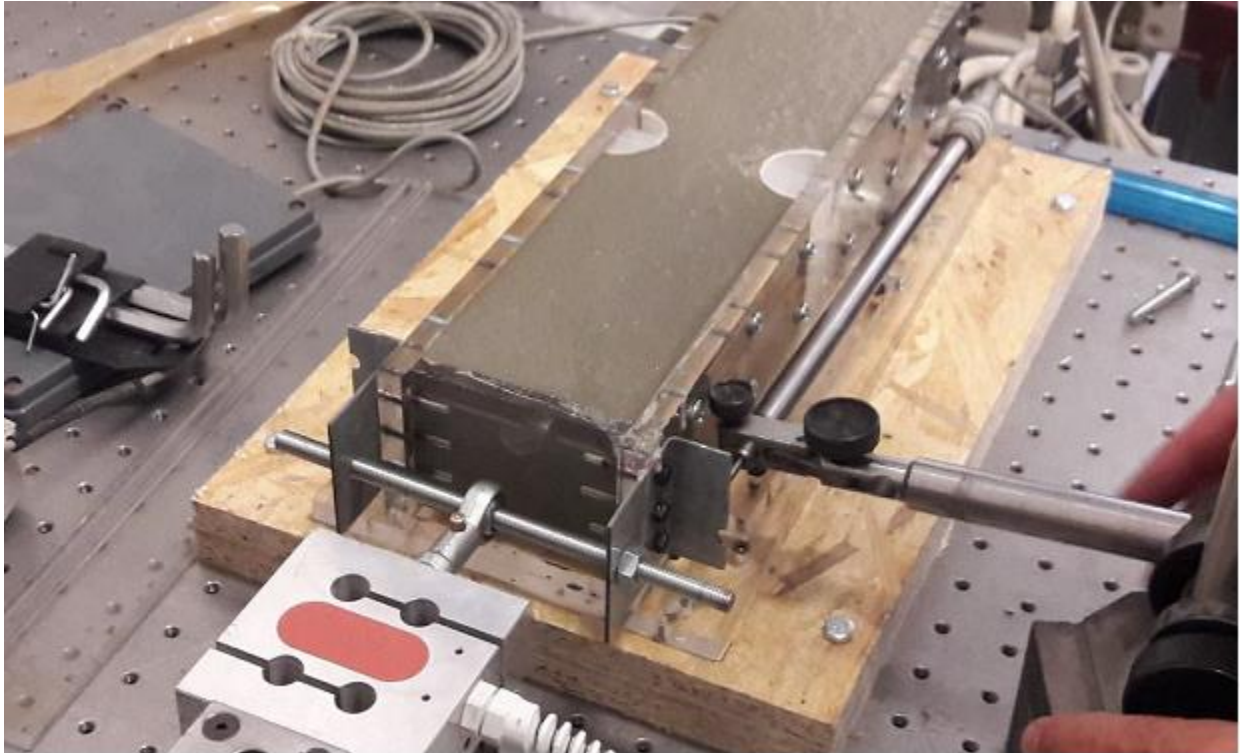

Figure 58. Tensile Test.

6.3 Slump Test:

The slump test, explained before, is aimed at measuring the “slump” or the flow in time of concrete by means of a cone-shaped metal piece, open on the upper and lower sides. The cone is placed on a horizontal surface, and concrete is poured into the cone through the upper opening. The apparatus with a known height, is filled to the top and then removed vertically in order to avoid concrete shifting. Difference in height of concrete from each trial is measured at different times, with the results presented later.



Figure 59. Performed Slump Test.

IV. Experimental Results

9 different trials were done for each test (shear and tensile). The Shear and Slump tests were done using Mix 1, while the Tensile tests were done using Mix 2. The charts showing the force in Kg, and the displacement in mm, are displayed in Appendix A.

1. Experimental Data:

The time at which each trial was done is indicated in the table below.

Shear (Mix 1)		Tension (Mix 2)		Slump (Mix 1)	
Trial	Time Elapsed (mins)	Trial	Time Elapsed (mins)	Trial	Time Elapsed (mins)
1	110	1	100	5	1
6	110	6	110	2	60
8	130	8	130	6	60
3	140	3	140	7	90
7	150	7	145	9	90
9	160	9	150	4	120
4	170	4	175	8	170
2	200	2	190	3	200
5	210	5	200		

Table 6. Time Elapsed (minutes).

Tabled results are summarized in the figures 60 to 77 below showing Nominal Shear Stress vs. Displacement for the shear tests, and Nominal Stress vs. Displacement for the tensile tests:

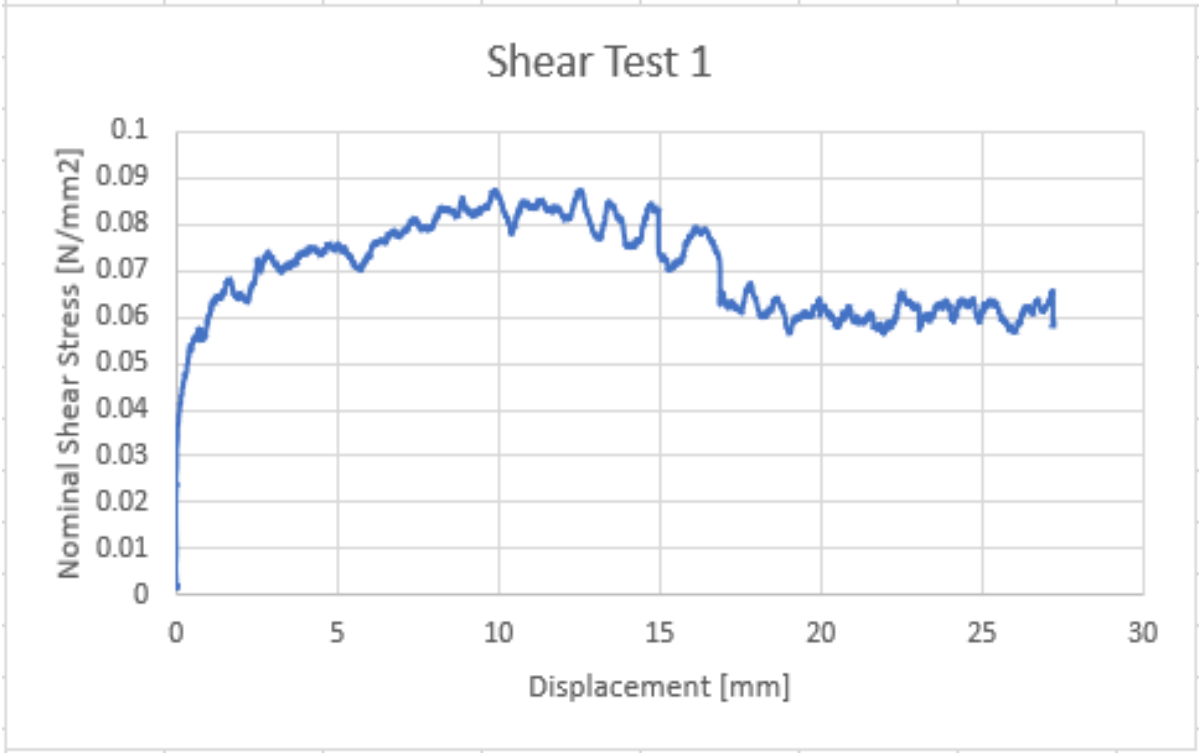

Figure 60. Shear Test 1 at 110mins.

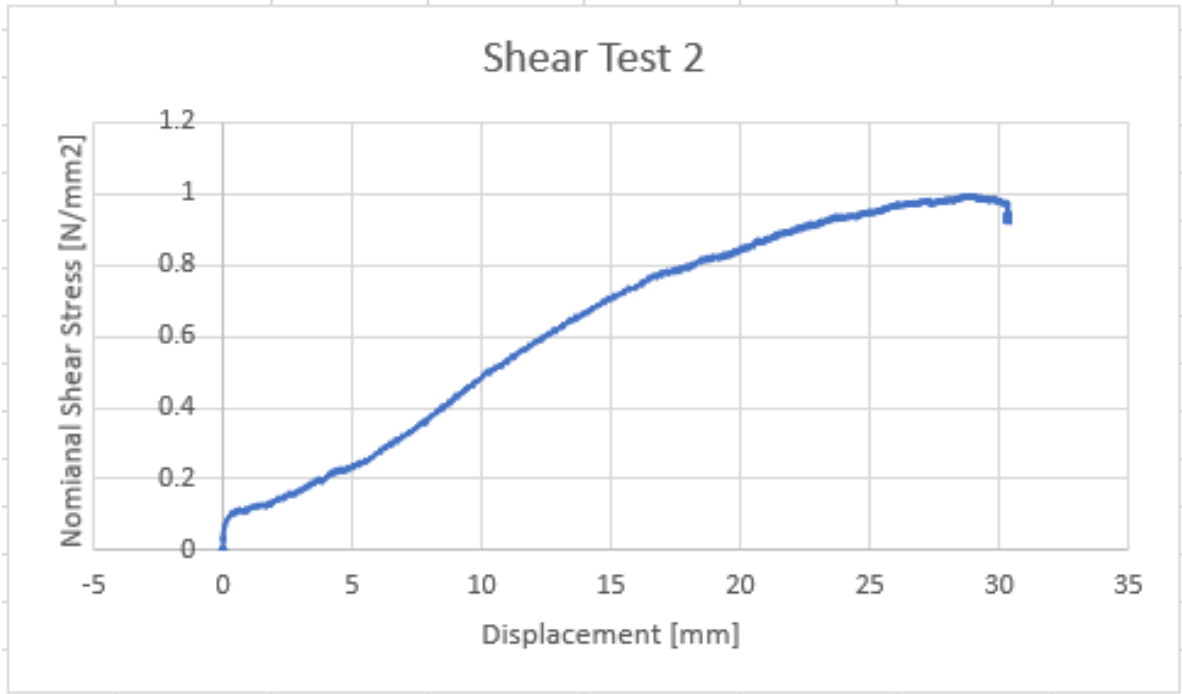

Figure 61. Shear Test 2 at 200mins.

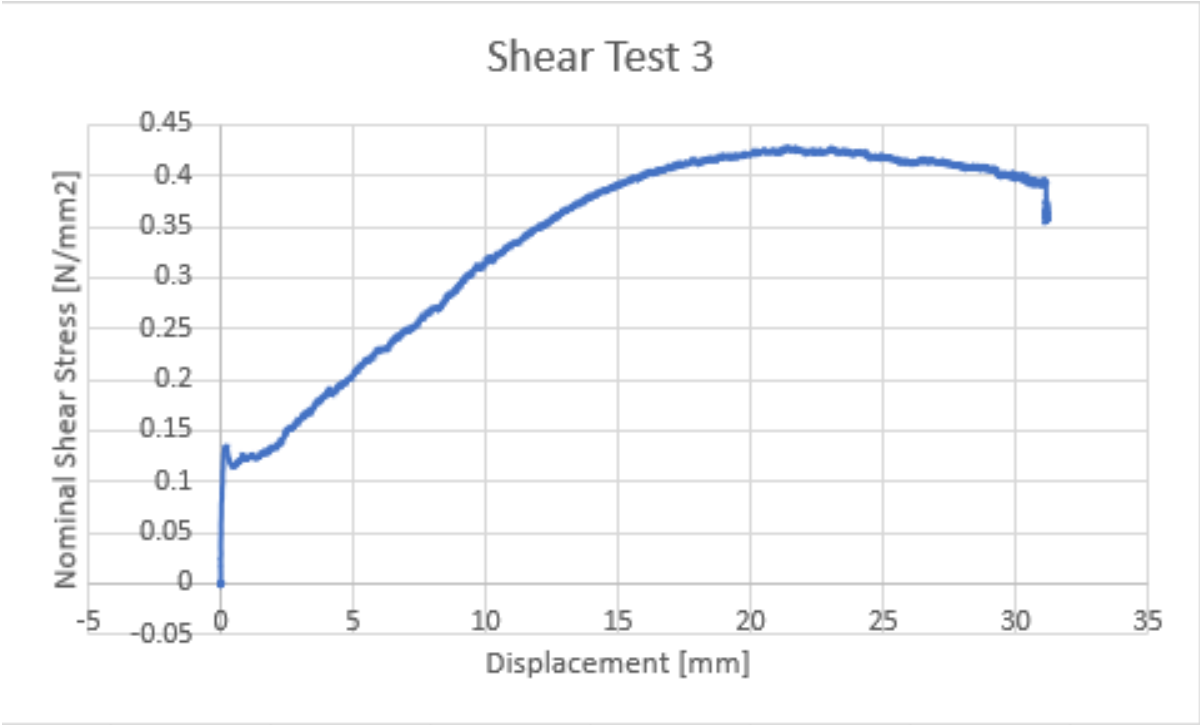

Figure 62. Shear Test 3 at 140mins.

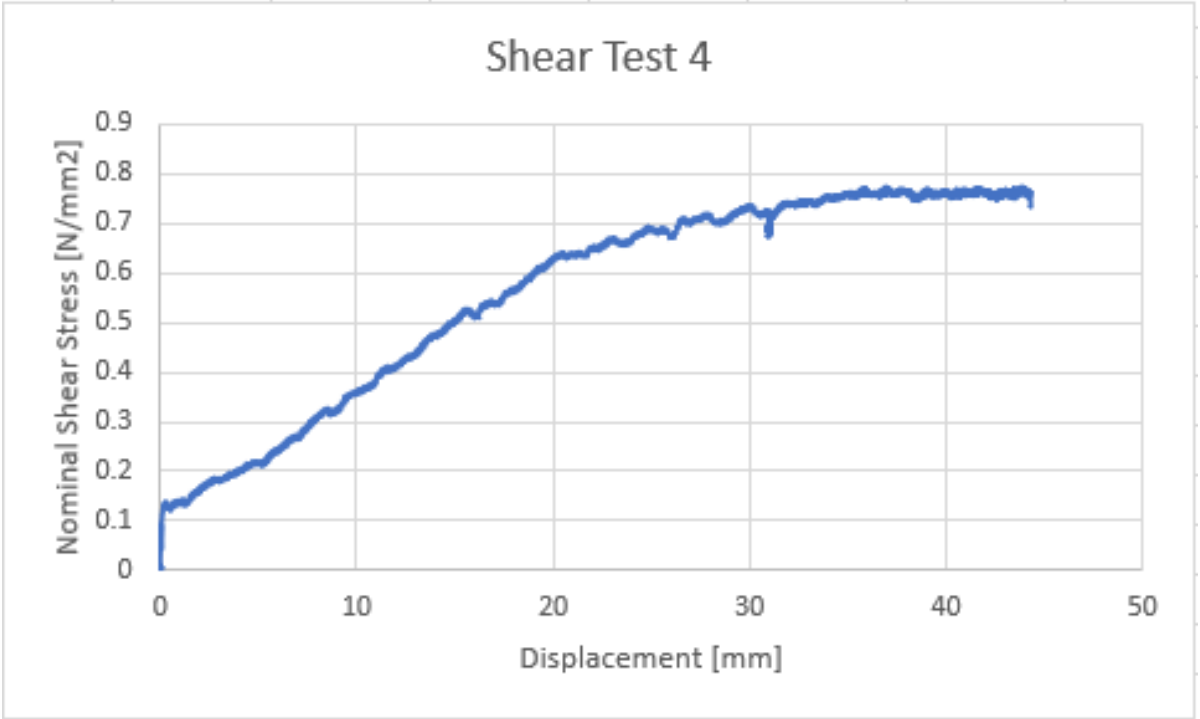

Figure 63. Shear Test 4 at 170mins.

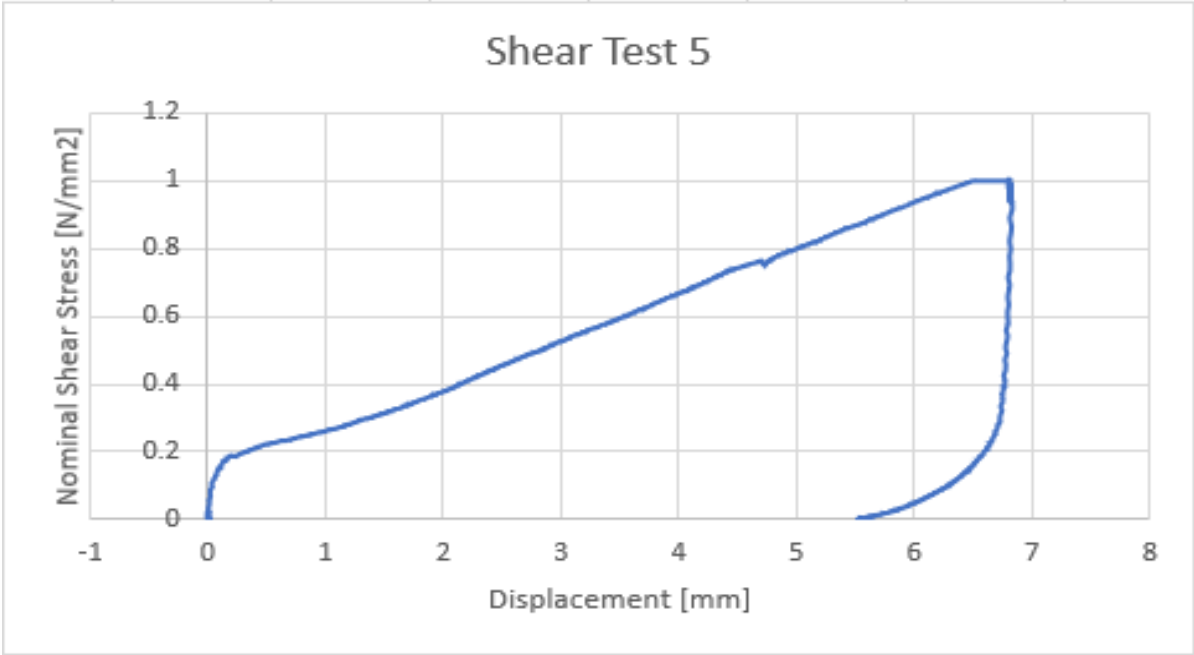

Figure 64. Shear Test 5 at 210mins.

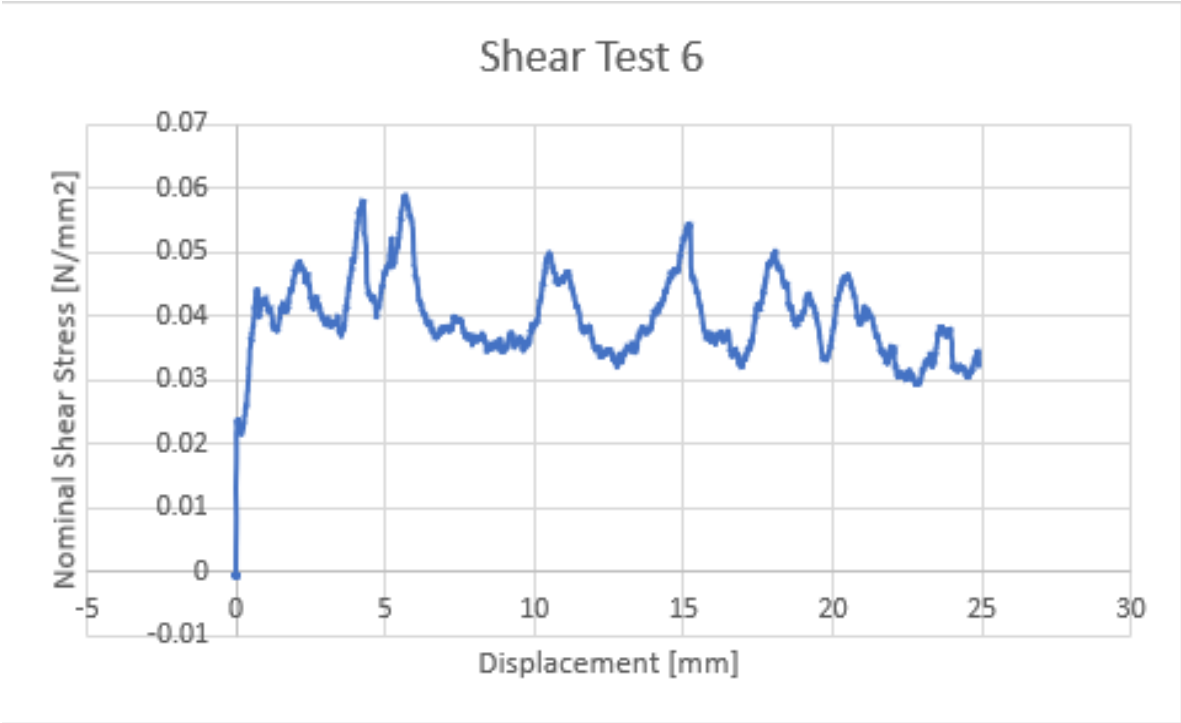

Figure 65. Shear Test 6 at 110mins.

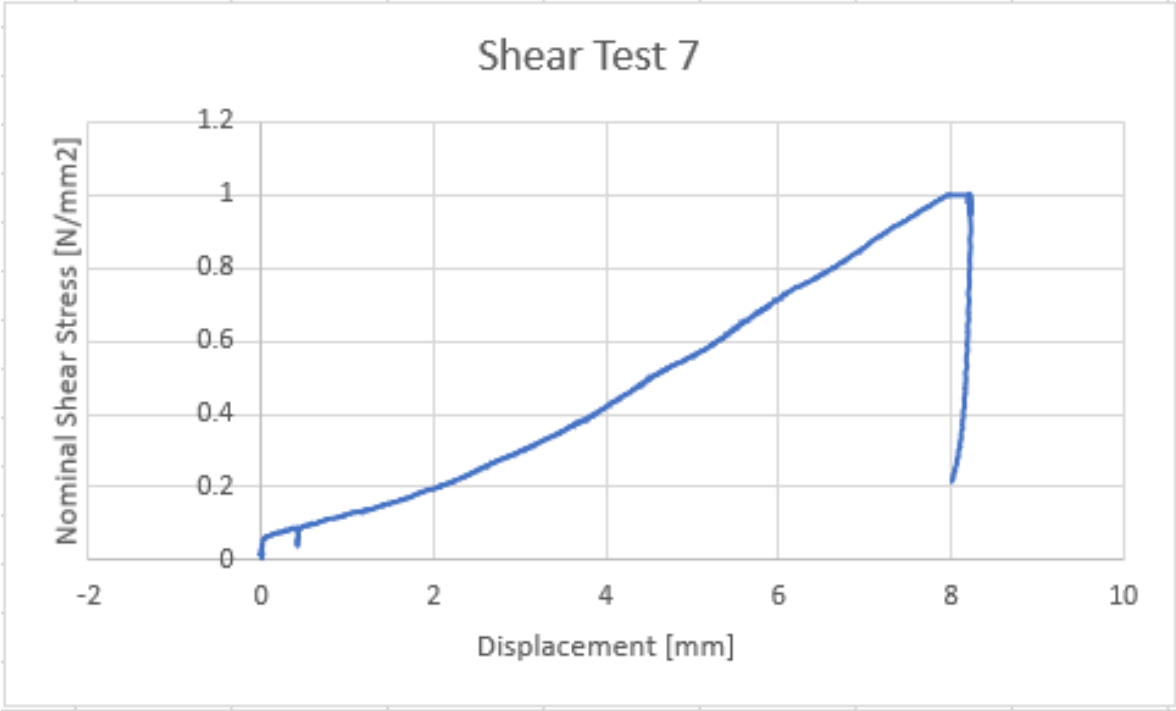

Figure 66. Shear Test 7 at 150mins.

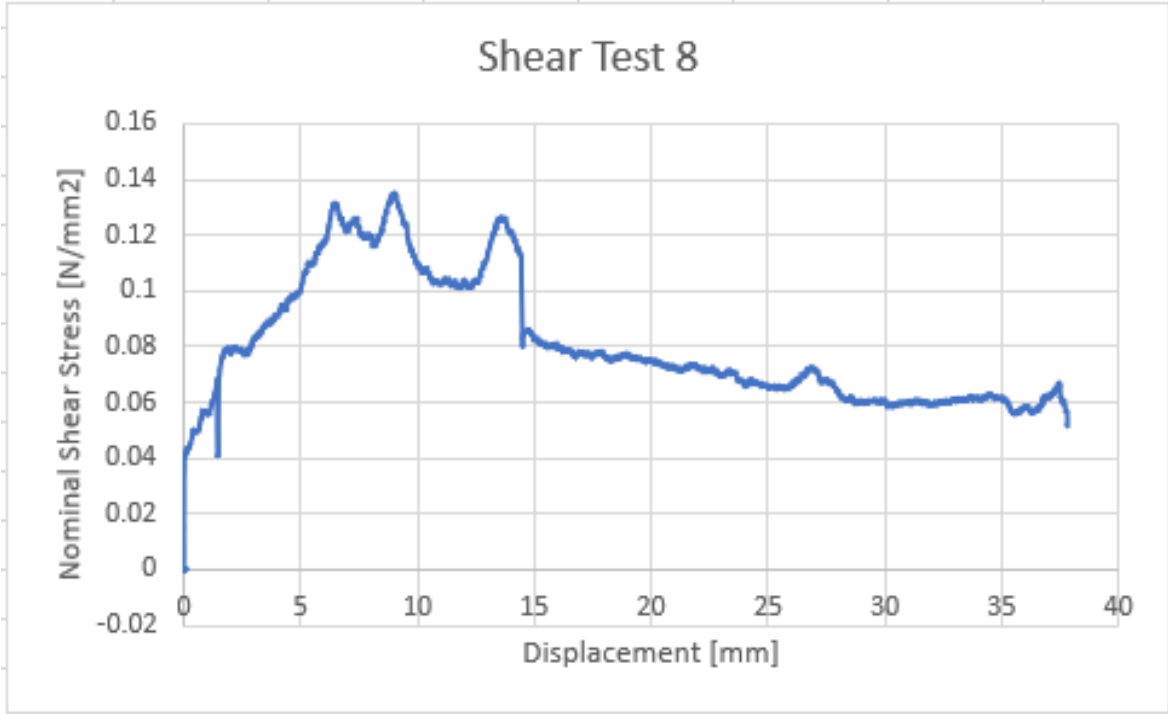

Figure 67. Shear Test 8 at 130mins.

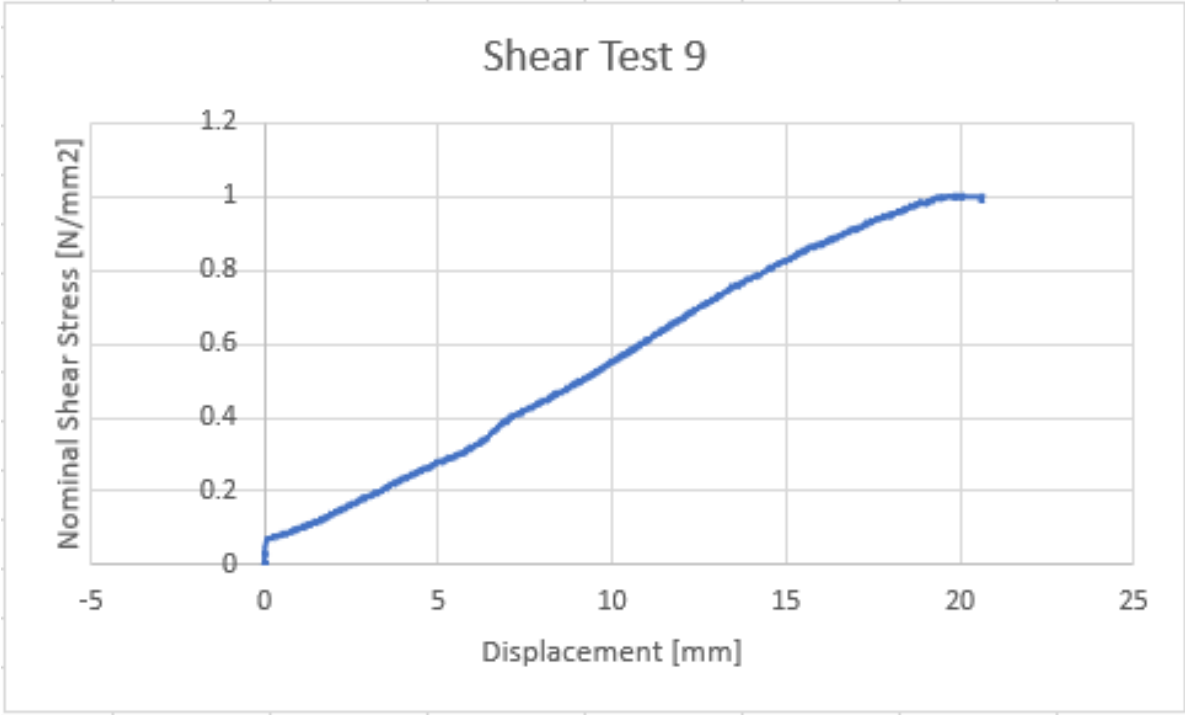

Figure 68. Shear Test 9 at 160 mins.

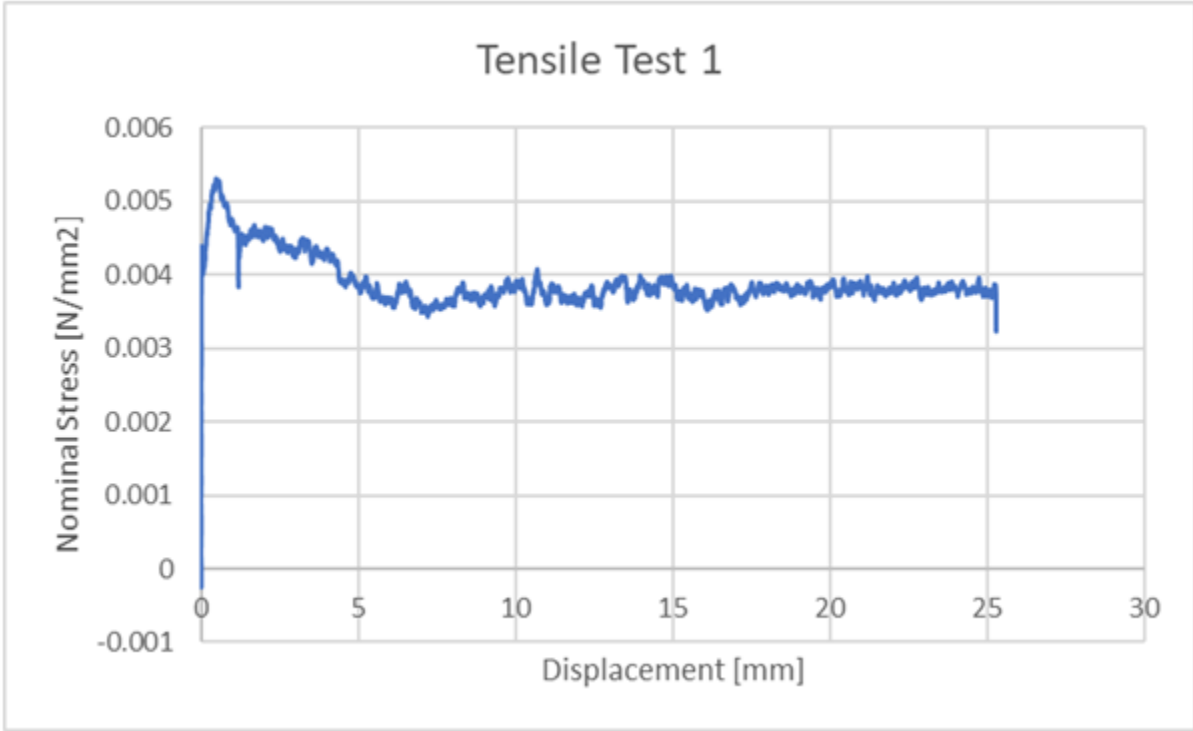

Figure 69. Tensile Test 1 at 100mins.

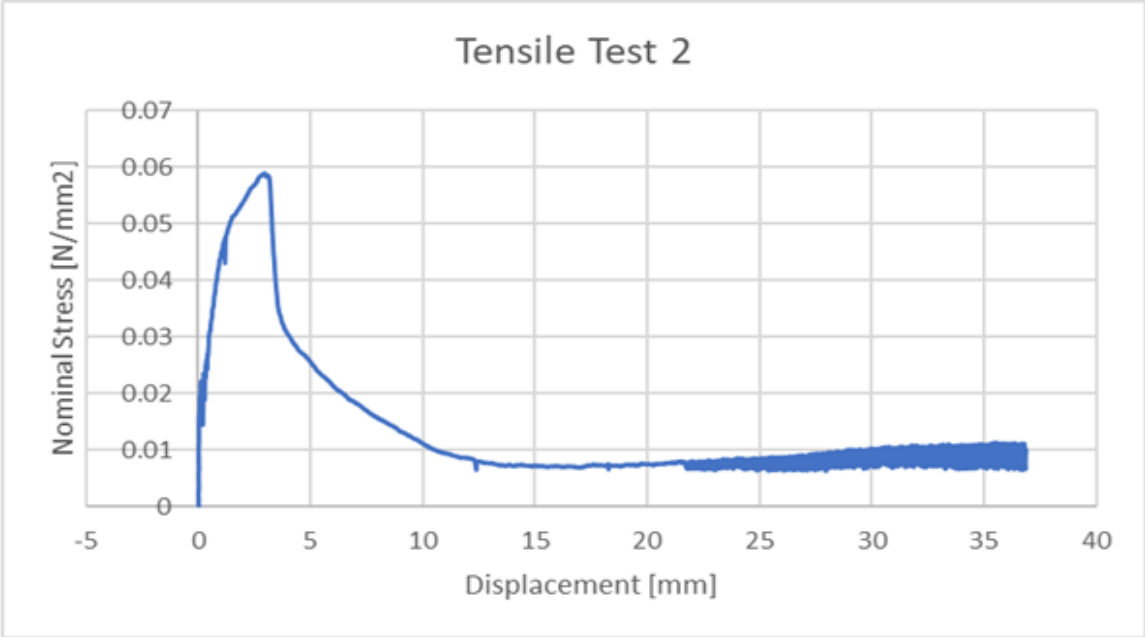

Figure 70. Tensile Test 2 at 190mins.

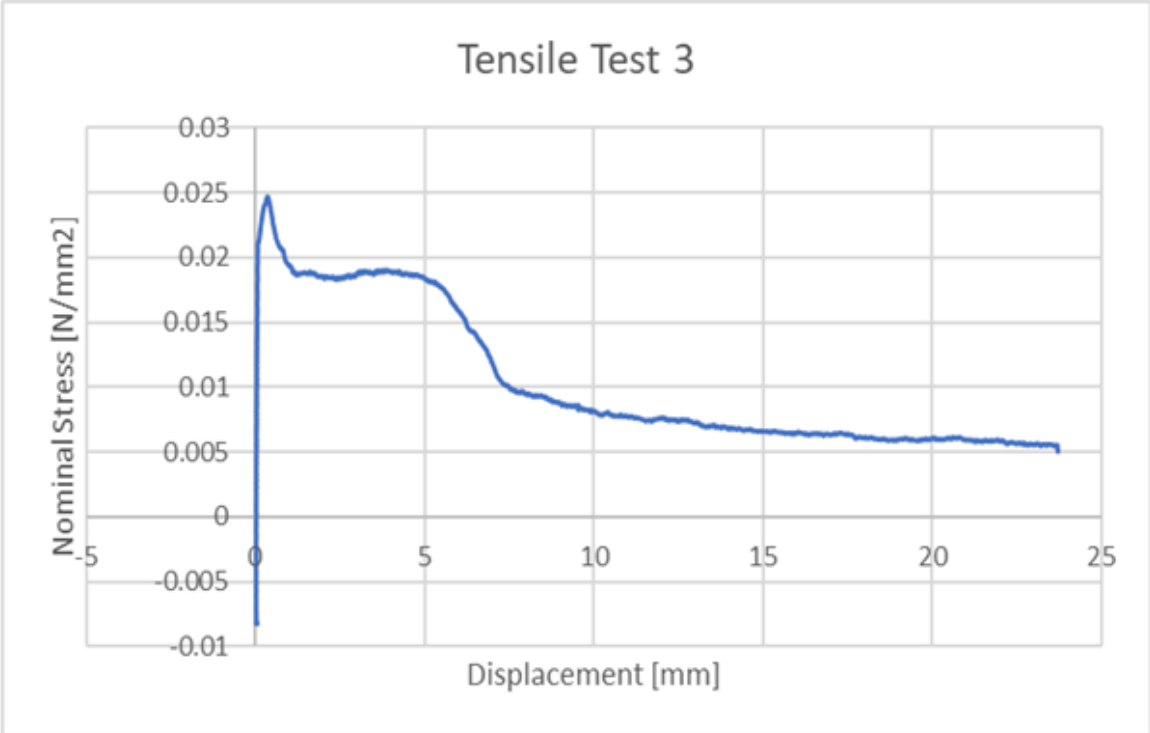

Figure 71. Tensile Test 3 at 140mins.

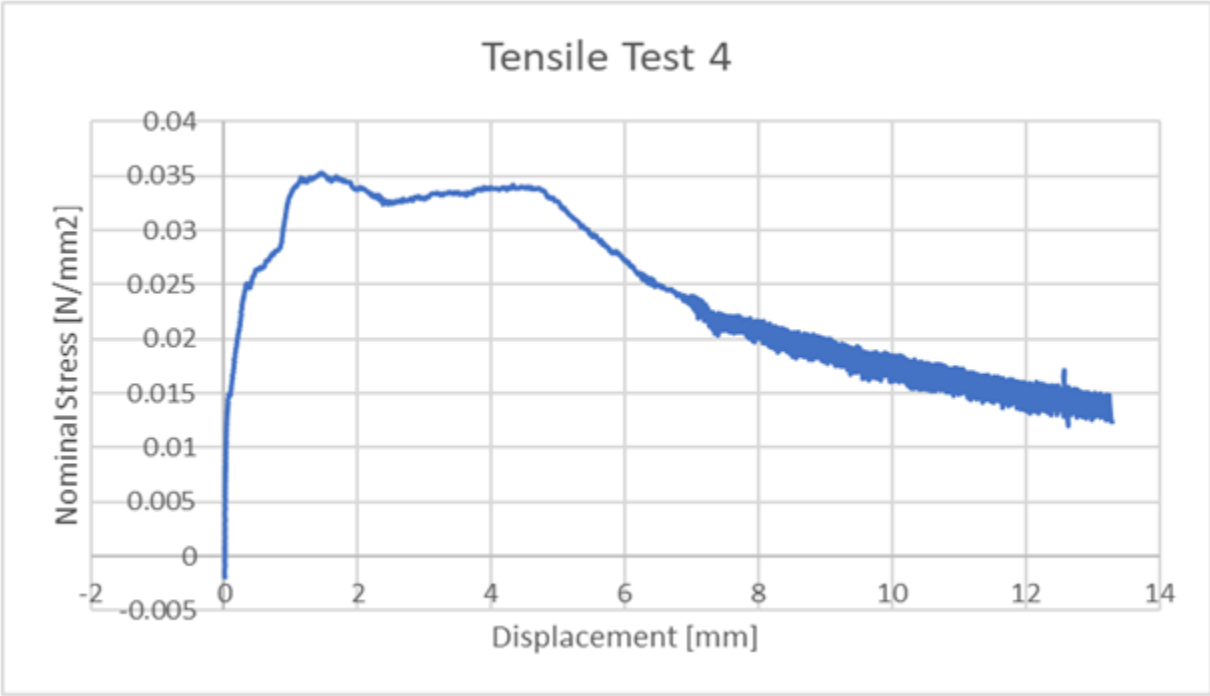

Figure 72. Tensile Test 4 at 175mins.

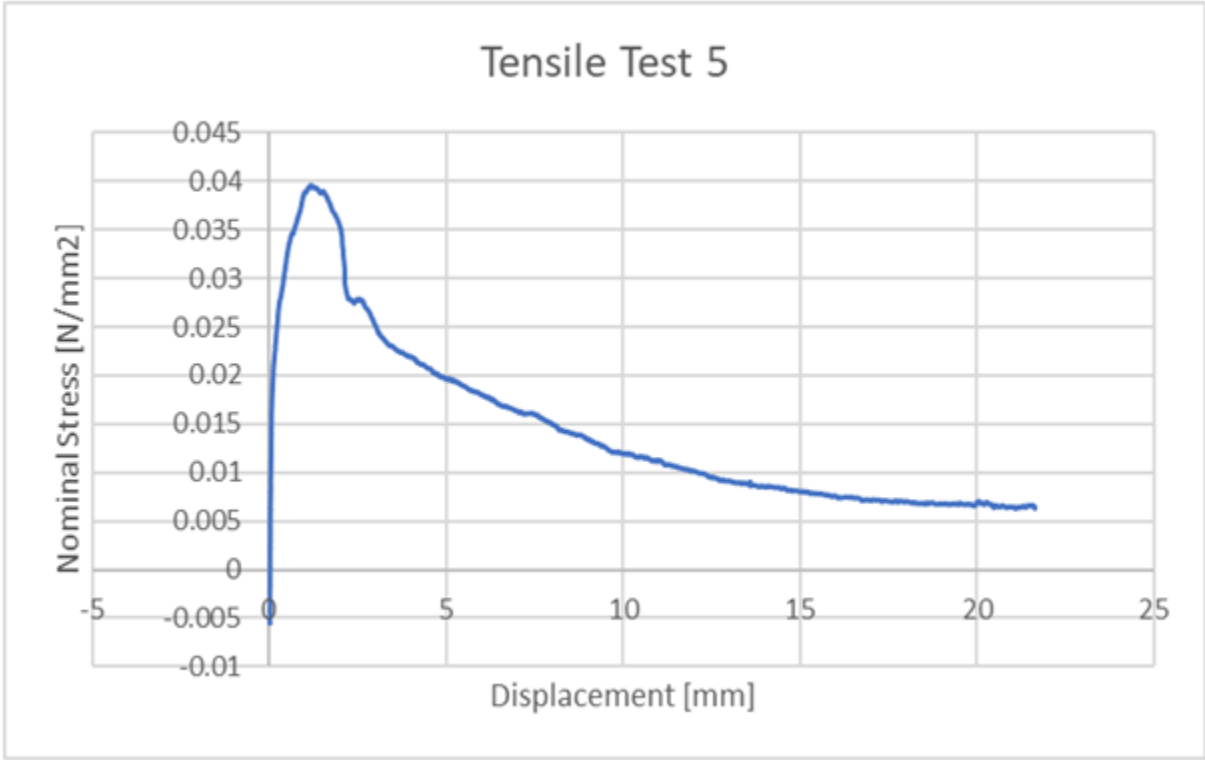
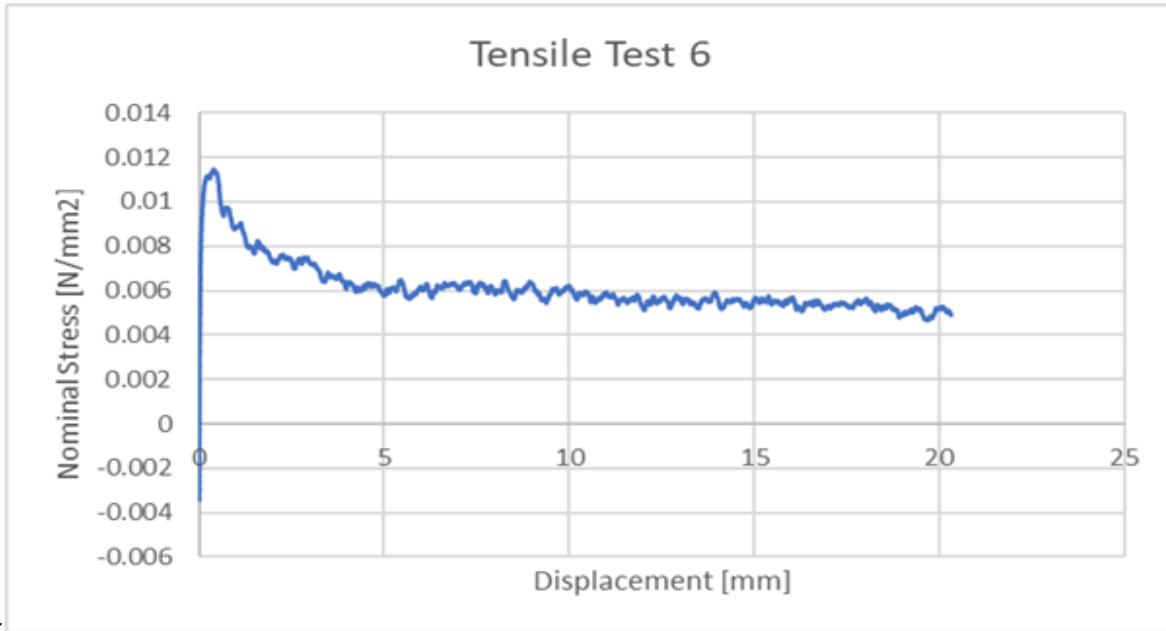

Figure 73. Tensile Test 5 at 200mins.



kkk

Figure 74. Tensile Test 6 at 110mins.

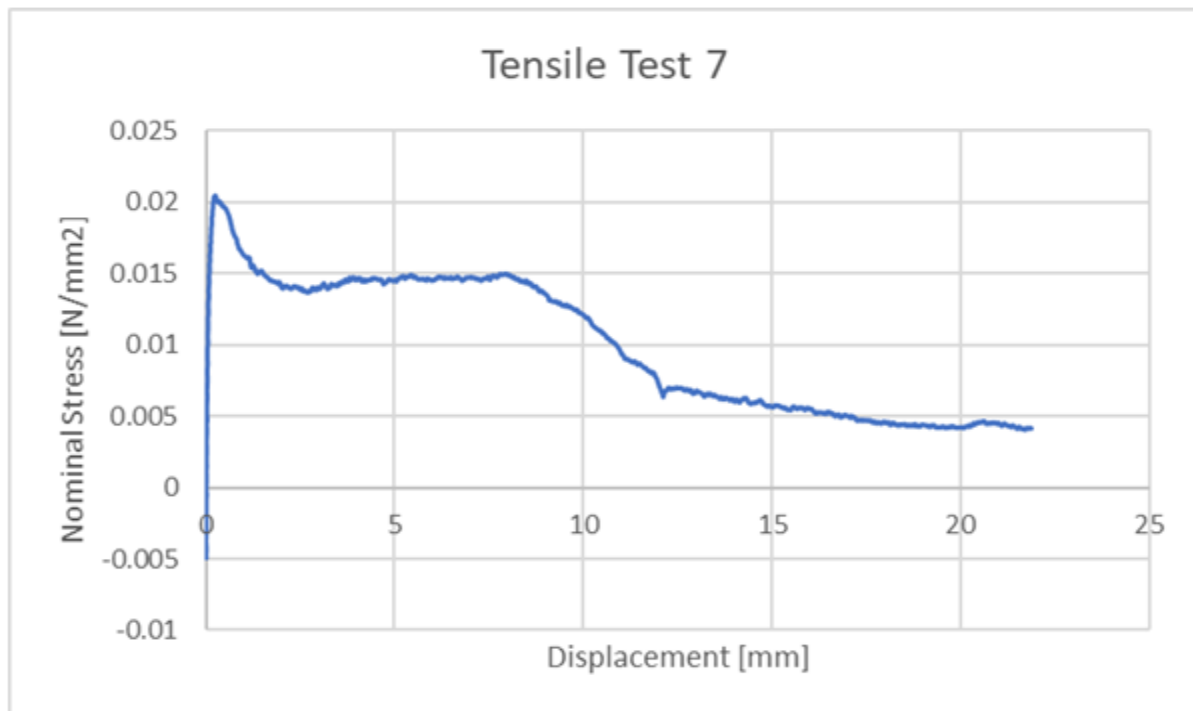

Figure 75. Tensile Test 7 at 145mins.

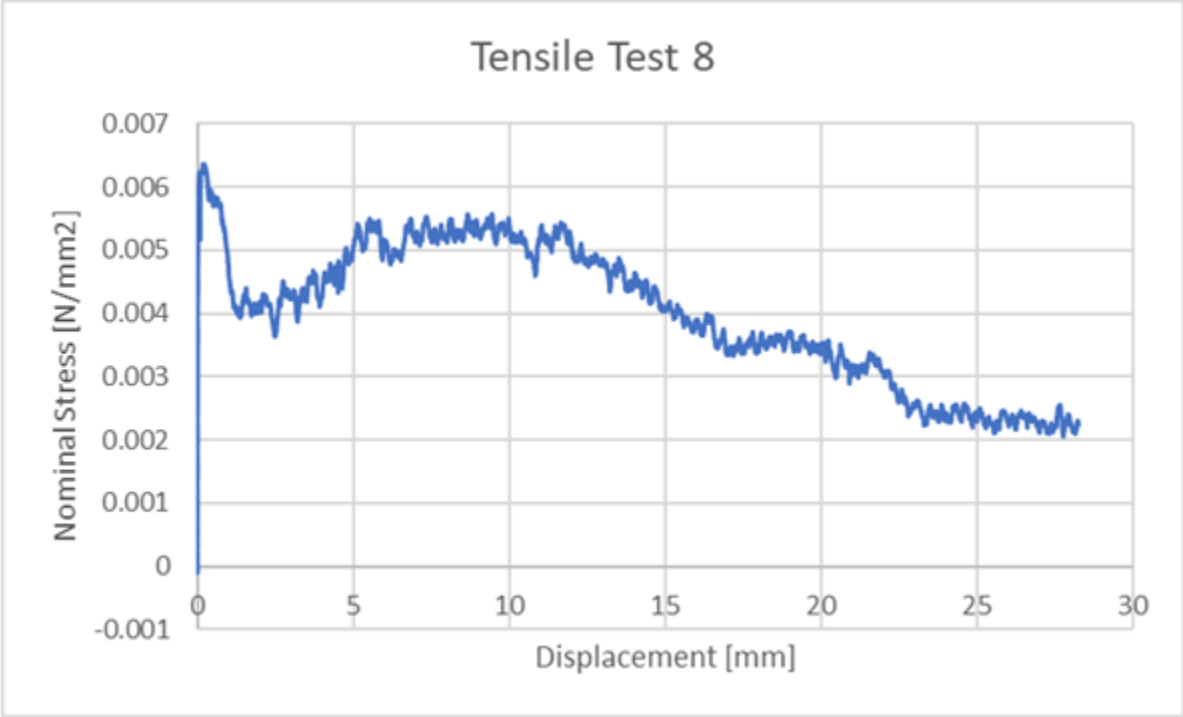

Figure 76. Tensile Test 8 at 130mins.

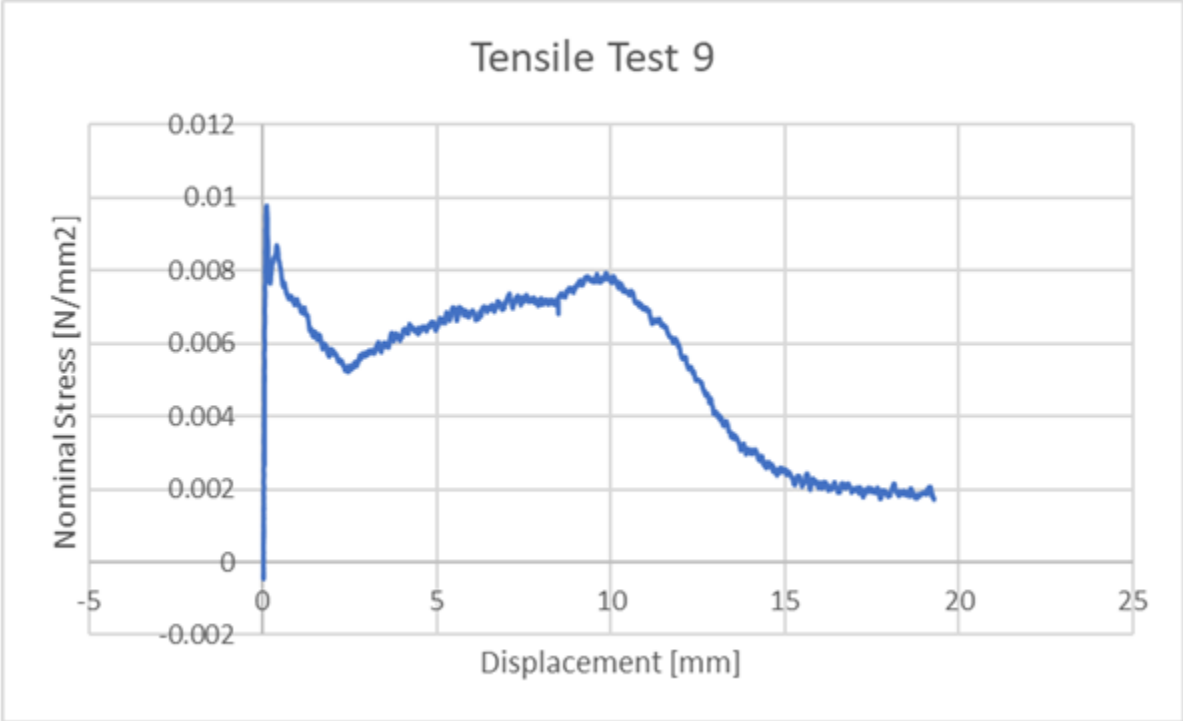

Figure 77. Tensile Test 9 at 150mins.

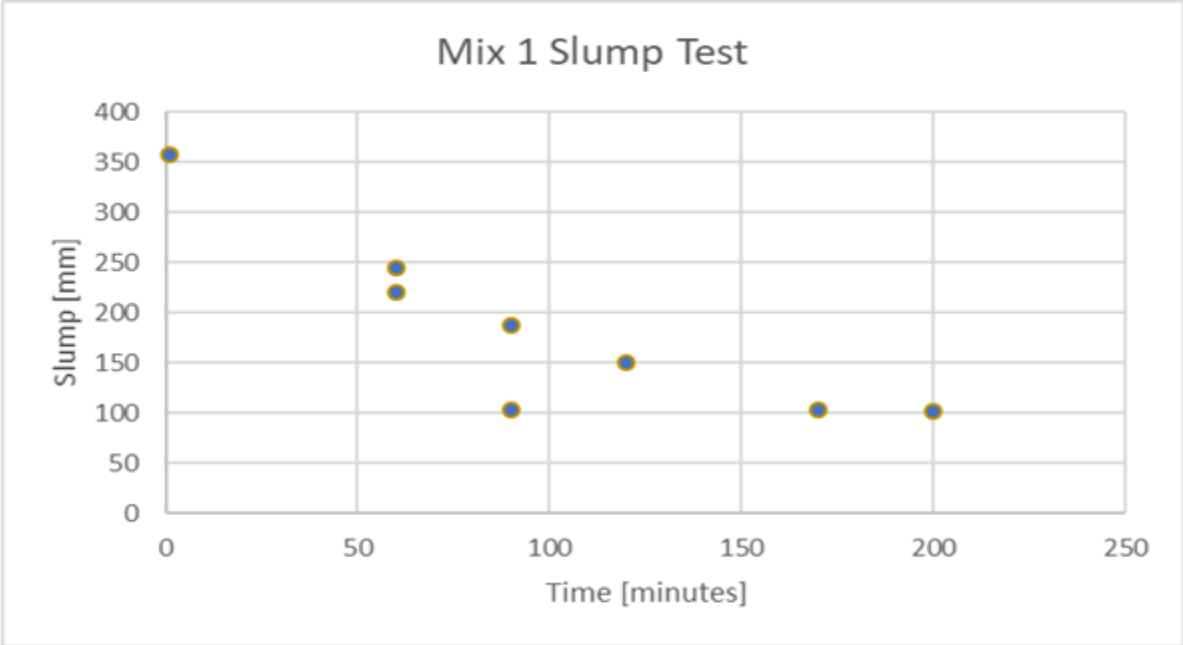

Figure 78. Slump (mm) vs. Time (min) Scatter of Mix 1.

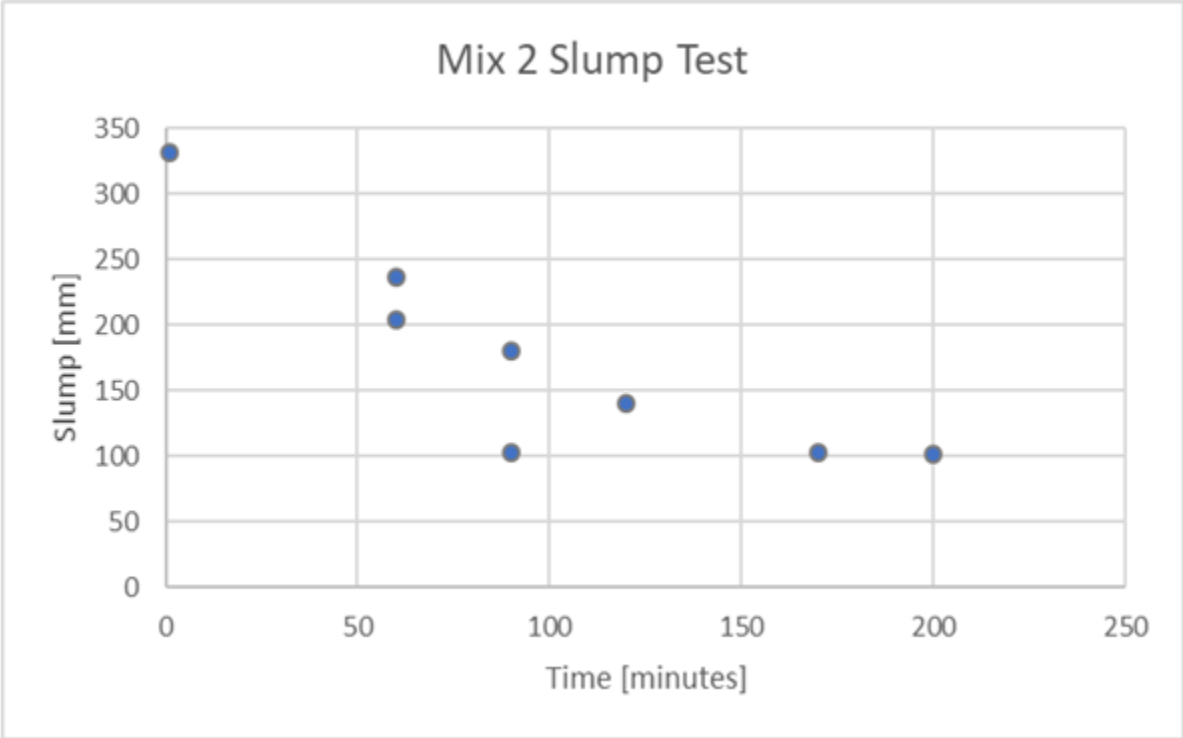

Figure 79. Slump (mm) vs. Time (min) Scatter of Mix 2.

2. Shear Analysis:

As can be seen from the figures 60-68 above, a small force build-up eventually causes the system to move. The tests show that the trials done at a time elapsed of 150 minutes or less manifest a significantly lower maximum withstood force. Two trials done at 110 minutes show that a force as little as 5.14 Kg and 3 Kg at this point could cause shear failure. Test done at 130 minutes shows a slight improvement in shear strength, with the maximum load reaching 8 Kg, while the test done at 140 minutes shows a greater improvement in strength with a maximum value of 25 Kg. At 150 minutes, maximum load applied exceeded 60 Kgs, which is the maximum the used machine could measure in the current study. Similar results were obtained at 160 and 210 minutes. Note that after in trial 4, at 170 minutes, the used mix could only withstand 46 Kgs, less than it could at 150 minutes. This discrepancy in results is expected, due to the different times during which the mixtures were done. Every trial run had its mix redone. Under different temperature and humidity conditions (differing from day to day), the results may vary. This however is neglected, as the shear strength test shows an improvement in shear resistance as time passes on the mix, mainly due to the hydration and hardening process.



Figure 80. Shear Failure at 130mins.

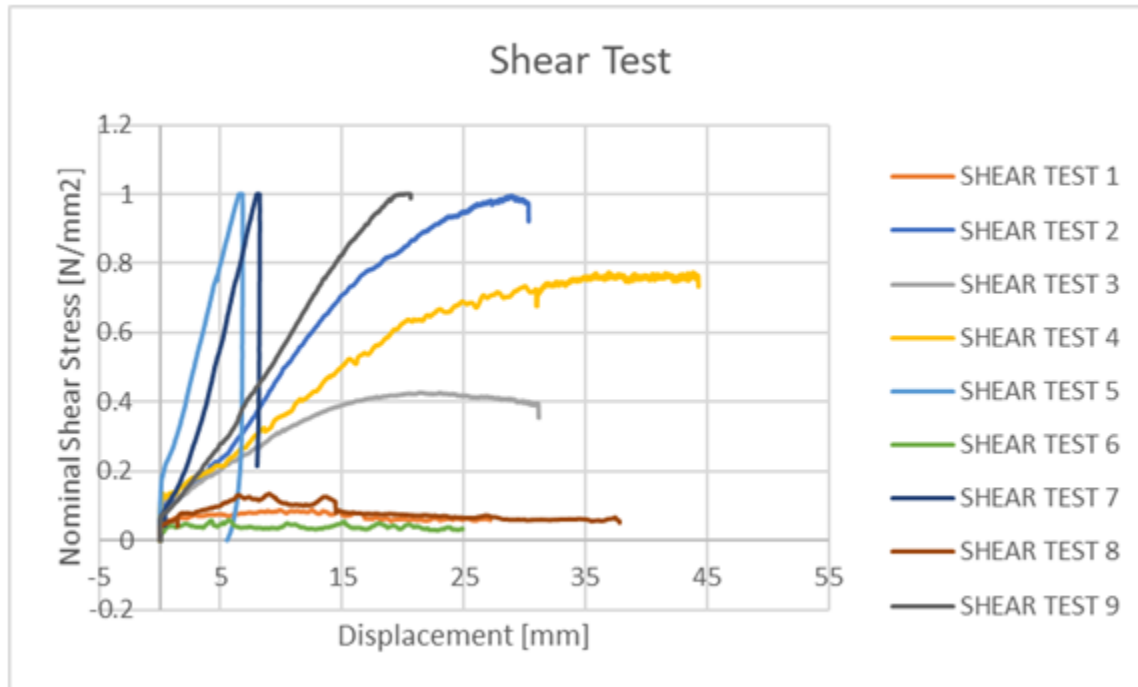

Figure 81. Shear F vs D Superposition.

Labeled from 1 to 9 are the shear tests done in each trial (1-9) respectively where each color corresponds to the indicated graph in the legends. As mentioned earlier, the maximum attainable load is 60 Kgs, therefore the maximum Nominal Shear Stress applicable is $(60\text{Kgs}) \cdot (10\text{m/s}^2) / (10\text{mm} \cdot 60\text{mm}) = 1 \text{ N/mm}^2$.

3. Tensile Analysis:

Similar to the shear tests, the tensile tests depicted earlier in Figures 69-77 show an initial build up of stress before a significant movement is observed. In these tests, the maximum applicable nominal stress is $(60\text{kgs}) \cdot (10\text{m/s}^2) / (60 \cdot 60) = 0.16 \text{ N/mm}^2$. The earliest test was done at 100 mins (trial 1), and resulted in a tensile strength of 1.99 Kgs. The sixth trial, done at 110 mins, shows a maximum resistance of 4 Kgs. Trials 7,8, and 9, done at 145, 130, and 150 minutes respectively, showed a lower than expected maximum tensile load resisting capacity of 7, 2, and

4 Kgs. Trial 3, performed at 140 minutes resisted 11 Kgs before failure. Tests executed at 190 (trial 2) and 200 (trial 5) minutes failed at 19 and 15 Kgs respectively. A general trend showing the increase in tensile strength as more time passes on the mix also appears, while an early development of strength can be inspected. Similar to the shear tests, the mixing procedure was redone for every test, and therefore different conditions such as temperature and humidity could affect results. Failure happened across one line, where a reduction in cross-sectional area was applied by the two opposing half-pipes as can be observed on the figure below.

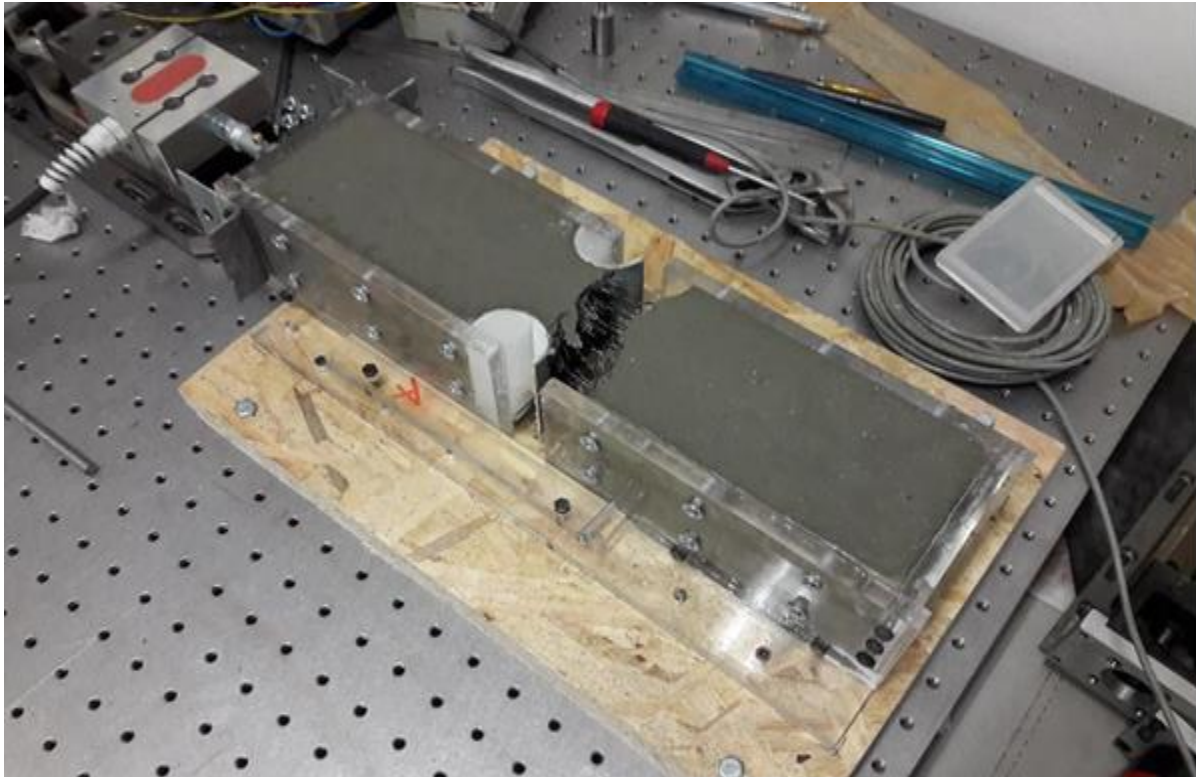

Figure 82. Tension Failure.

In the figure 81 below, superimposed results of the tensile tests are shown, indicating an expected trend. Series 1-9 correspond to trials 1-9 indicated in the figure legend.

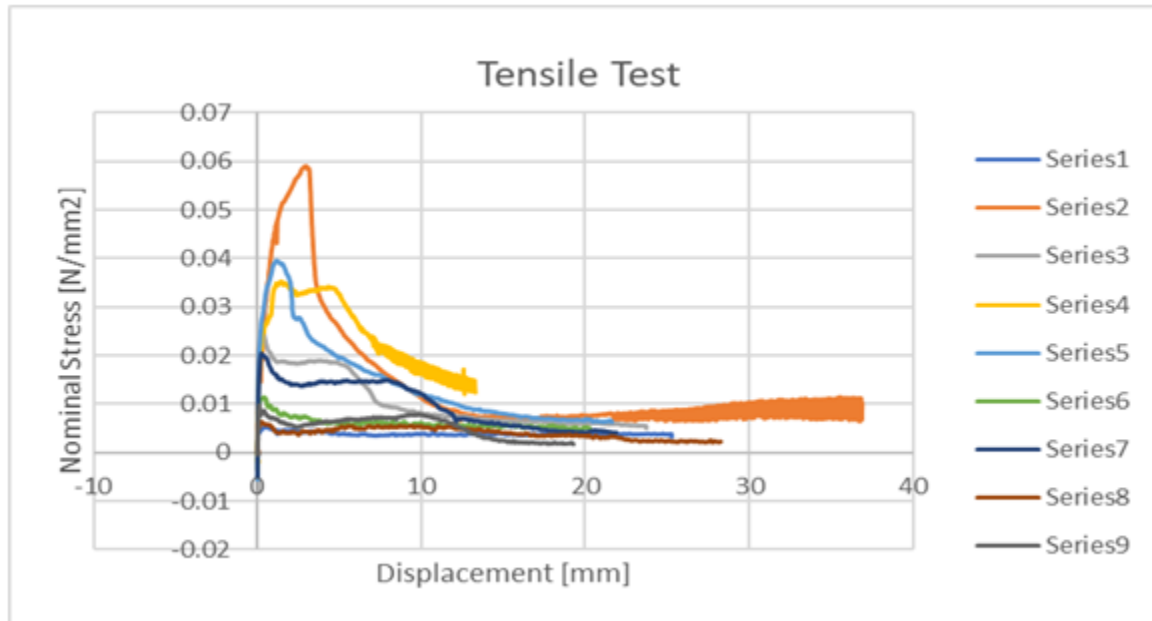

Figure 83. Tensile F vs. D Superposition.

4. Slump Analysis:

Slump tests done on both mixes (1 & 2) show a consistent relation between time elapsed and slump decrease. Tests done in trial 5 at the first minute showed a slump of 358 and 332 mm for mixes 1 and 2 respectively. Tests done at 60 minutes in both trials 2 and 6 showed a decrease in slump to 245 and 221 mm for mix 1, and 237 and 204 mm for mix 2. Two tests done at 90 minutes show 103 mm for mix 1 and mix 2 in trial 7, while a slump of 187 and 180 mm is obtained in trial 9 for mix 1 and mix 2 respectively. In trial 4, at 120 minutes, 151 and 140 mm slumps are obtained for mix 1 and 2 respectively. After 170 minutes have elapsed, the slump value decreases drastically to 103 mm for both mixes (trial 8), and to 102 mm for both mixes at 200 minutes (trial 3). An expected relation between time elapsed and decrease in slump is obtained, which gives an indication about the rheology of fresh concrete.

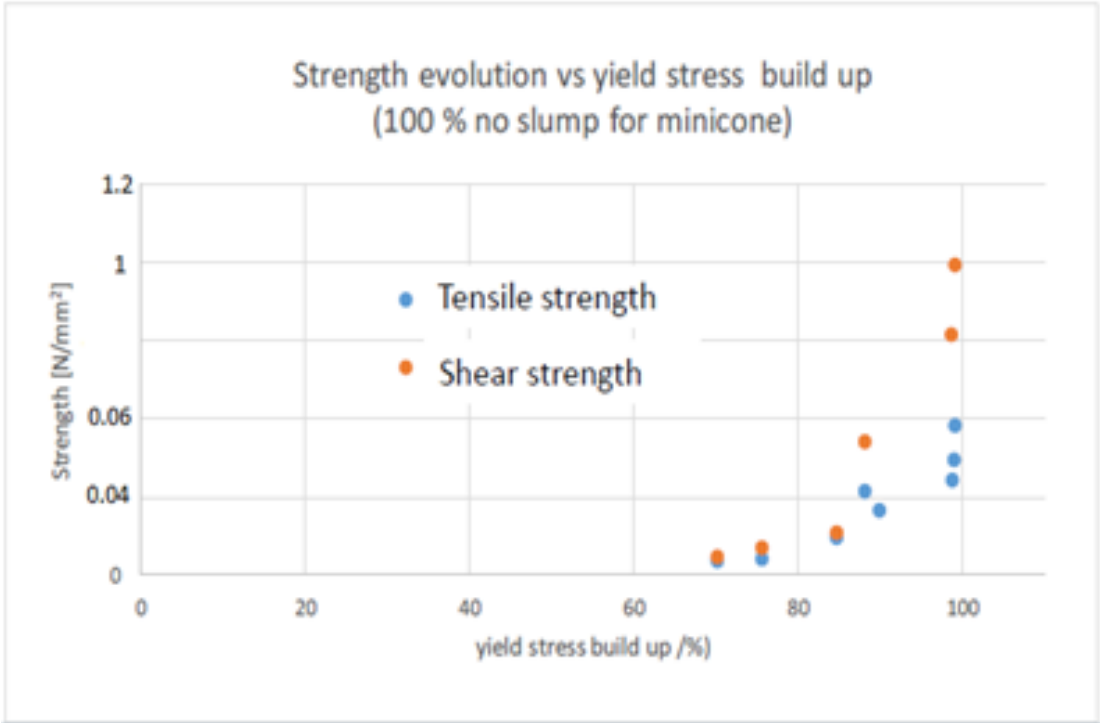

Figure 84. Strength Evolution vs. Yield Stress Build Up.

It can be observed from the above figure 81 that as the strength of concrete builds up, it's slump decreases, which correlates between rheology and strength development in fresh concrete.

V. Conclusions and Further Work

Clear indications about the evolution of early strength in fresh concrete have been presented in the above data. The tests designed for the current experiments show consistent results with respect to shear and tensile capacity evolution in time. As the elapsed time increased, higher shear and tensile reactions were developed in concrete due to the continuing hydration process that concrete undergoes. Slump tests also show a clear correlation between increase in elapsed time and decrease in slump value. A relationship between strength evolution and slump is also drawn, where higher strengths indicate lower slumps.

Keeping in mind that the tested concrete is fiber reinforced, these tests could be applied to other mixes in order to test their early strength development properties, as admissible results could be obtained. Fiber reinforced high strength cementitious composites designed and developed for 3D printing purposes could be tested using these apparatuses. Printing in different directions and along different paths alters the behaviour of the printed concrete along a specific axis, and therefore observing the difference in resistances between different printed layer orientation configurations is possible using these tests.

Other tests such as compression and punch through tests can be performed in order to obtain more accurate results, while a flexural test might be difficult to realize at such early concrete age.

References

- 3D Compare on Demand Manufacturing. [Online image]. Retrieved from 3dcomapre.com
- 3D Printing Industry. [Online image]. Retrieved from 2dprintingindustry.com
- Additively. [Online image]. Retrieved from additively.com
- Alec. (2014). *Slovenian construction pioneers BetAbram share footage of their 3D house printers in action*. Retrieved August 2018, from 3ders.org.
- Anderson, S. (2014, November). *LU and Skanska Sign Collaborative Agreement to Commercialize 3D Concrete Printing Robot*. Retrieved August 2018, from 3dprint.com.
- ASTM International. (2013). *Standard Terminology for Additive Manufacturing Technologies 1,2*. United States of America: ASTM International.
- B.V. Perera, B.V. (1940). Process of Making Relief Maps , *Patent #2,189,592*, United States
- Beaman, J., Barlow, J., Bourell, D., Crawford, R., Marcus, H., & McAlea, K. (1997). *Solid freeform fabrication: A new direction in manufacturing*. Dordrecht: Kluwer Academic Publishers.
- Blanthier, J.E. (1892). Manufacture of Contour Relief Maps, *Patent #473,901*, United States
- Bos, F., Wolfs, R., Ahmed, Z. & Salet. T. (2016) Additive manufacturing of concrete in construction: potentials and challenges of 3D concrete printing, *Virtual and Physical Prototyping*, 11(3), 209-225, DOI: [10.1080/17452759.2016.1209867](https://doi.org/10.1080/17452759.2016.1209867)
- C. Baese, C. (1904). Photographic Process for the Reproduction of Plastic Objects, *Patent #774,549*, United States.
- Ciraud, P. A. (1972). *Patent No. 2263777*. France.Hopkinsons
- Colla, V. & Dini, E. (2013). *Large Scale 3D Printing: from Deep Sea to the Moon*. Italy: ICTP-Abdus Salam Center for Theoretical Physics
- Conner, B., Manogahrang, G, Martof, A., Rodomski, L., Rodomski, C., Jordan, D., Limperos, J. (2014). Making Sense of 3D Printing: Creating an App of Additive Manufacturing Products and Services. *Additive Manufacturing*, 1(4), 64-76
- Contour Crafting Corporation. (2017). Introducing Contour Crafting Technology, *Contour Crafting Corporation*
- Cummins, K. (2010). The rise of additive manufacturing, *the Engineer Jobs*

- Dini, E. (2006). *Method and Device for Building Automatically Conglomerate Structures*. Patent: United States of America
- Dini, E. (2008). *METHOD FOR AUTOMATICALLY PRODUCING A CONGLOMERATE STRUCTURE AND APPARATUS THEREFOR*. Patent: United States of America
- Farzam, H. (2000). *Cement and Concrete Terminology, AC 116R-00*
- Griffith, M.L., Keicher, D., Harwell, L.D., & Greene, D.L. (1996). *Free From Fabrication of Metallic Components Using Laser Engineered Net Shaping (LENSTM)*, Sandia National Laboratories
- Hambach, M., & Volkmer, D. (2017). Properties of 3D-printed fiber-reinforced Portland cement paste. *Cement and concrete composites*, 79, 62-70
- Hopkinson, N., & Dickens, P. (2003). Analysis of rapid manufacturing – using layer manufacturing processes for production, Proceedings of Institution of Mechanical Engineers Part C. *Journal of Mechanical Engineering Science*, 217(1), 31-40.
- Hwang, D., & Khoshnevis, B. (2005). An Innovative Construction Process-Contour Crafting (CC). *ISARC 2005*
- Indiamart. [Online image]. Retrieved from indiamart.com
- Jacobs, P. (1992). *Rapid prototyping & manufacturing: fundamentals of stereolithography*. United States of America: Society of Manufacturing Engineers
- Keisher, D., Love, J., Dullea, K., Bullen, J., Gorman, P. & Smith, M. (2014). *Patent No. 6,811,744*. United States of America
- Khaing, Fuh, Lu (2011). Direct metal laser sintering for rapid tooling: processing and characterization of EOS parts
- Khoshnevis, B. (2004). Automated Construction by Contour Crafting-Related Robotics and Information technologies. *Automation in Construction*, 13(1), 5-19
- Khoshnevis, B. (2004). Houses of the Future – Construction by Contour Crafting Building Houses for Everyone. *University of Southern California Urban Initiative Public Policy Briefing*.
- Khoshnevis, B., Hwang, D., Yao, K., & Yeh, Z. (2006). Mega-scale fabrication by contour crafting. *Int. J. Industrial and Systems Engineering*, 1(3), 301-320.
- Kosmatka S.H., Panarese W.C. (1994). Design and Control of Concrete Mixtures. *PCA*

- Krassenstein, E. (2014). *WASP Plans to Demonstrate New 6 Meter Tall 3D House Printer This Week: Will 3D print houses in developing countries next*. Retrieved August 2018, from 3dprint.com.
- Le, T. Austin., S., Lim., S., Buswell., R., Law, R., Gibb., A., Thorpe., T. (2012). Hardened Properties of High Performance Printing Concrete. *Cement and Concrete Research*, 42(3), 558-556
- Le, T., Austin, S., Lim, S., Buswell, R., Law, R., Gibb, A., et al. (2011). Mix design and fresh properties for high-performance printing concrete. *Materials and Structures*, 1221-1232.
- LIM, S. (2011). Development of a viable concrete printing process. *Proceedings of the 28th International Symposium on Automation and Robotics in Construction, (ISARC2011), Seoul, South Korea, 29th June-2nd July 2011*, 665 - 670
- Lim, S., Le, T., Webster, J., Buswell, R., Austin, S., Gibb, A., & Thorpe, T. (2009). Fabricating construction components using layered manufacturing technology. *Department of Civil and Building Engineering, Loughborough University*
- Matsubara, k. (1974). Molding Method of Casting Using Photocurable Substance , *Japanese Kokai Patent Application, 51* (10813).
- Mettler, L., Wittel, F., Flatt, R., & Hermann, H.J. (2016). Evolution of Strength and Failure of SCC during Early Hydration, *Elsevier*
- Monolite UK Ltd. (2018). *D.shape Vision*. Retrieved September 2018 from www.d.shape.com
- Munz, O.J. (1956). Photo-Glyph Recording, *Patent #2,775,758*, United States.
- Panda, B., Paul, S., & Tan, M. (2017). Anisotropic mechanical performance of 3D printed fiber reinforced sustainable construction material. *Material Letters*, 209, 146-149.
- Pham, D.T., & Gault, R.S. (1997). A comparison of rapid prototyping technologies. *International Journal of Machine Tools & Manufacture*, 38, 1257-1287
- SCA Slag Cement Association. (2013). *Slag Cement*. Retrieved September 2018 from www.slagcement.org
- Scott, C. (2016, June). *Chinese Construction Company 3D Prints an Entire Two-Story House On-Site in 45 Days*. Retrieved from <https://3dprint.com/138664/huashang-tengda-3d-print-house/>
- SIAKY inc. Why Sciaky Beam, *Michigan Aerospace Manufacturers Association*. Retrieved September 2018 from www.sciaky.com

- Sing, S., An, J., Yeong, W., & Wiria, F. (2015). Laser and Electron-Beam Powder-Bed Additive Manufacturing of Metallic Implants: A Review on Processes, Materials and Designs. *Orthopaedic Research Society*
- Swainson, W. K. (1977). *Patent No. 4,041,476*. United States of America.
- The Technology House. *Sea Air Space Machining & Molding*. Retrieved September 2018 from www.tth.com
- Van Zijl, G. P. A. G., Paul, S. C., & Tan, M. J. (2016). Properties of 3D Printable Concrete. *Proceedings of the 2nd International Conference on Progress in Additive Manufacturing (Pro-AM 2016)*, 421-426.
- Varotsis, A.K. Introduction to SLA 3D Printing. *3D HUBS*. Retrieved September, 2018 from www.3dhubs.com
- Warren, T. (2018). This cheap 3D-printed home is a start for the 1 billion who lack shelter, *Vulcans on planet Earth*. Retrieved March, 2018 from www.theverge.com
- Warszawski A. & Navon R. (1998). Implementation of Robotics in Building: Current Status and Future Prospects. *Journal of Construction Engineering and Management*, 124(1), 31-41, 1998.
- Winson 3d Printing. (2017). Yingchuang Building Technique (Shanghai), *Co.Ltd. (WinSun)*
- Wolfs, R. (2015). 3D printing of concrete structures. *Graduation thesis, Eindhoven University of Technology*.
- Zein, I., Hutmacher, D., Tan, K., & Teoh. S. (2000). Fused deposition modeling of novel scaffold architectures for tissue engineering applications. *Biomaterials*, 23, 1169-1185
- Zhang J., & Khoshnevis, B. (2004). Optimal machine operation planning for construction by Contour Crafting. *Automation in Construction*, 29, 50-67

Annex A:

The following annex contains tabled results of force (Kg) vs displacement (mm) of shear trials 1-4 and tensile trials 5-8.

Shear1 F (Kg)	D (mm)	F (Kg)	D (mm)	F (Kg)	D (mm)	F (Kg)	D (mm)	F (Kg)	D (mm)
-0.119	-12.516	-4.553	-7.8	-4.738	-2.068	-4.73	3.661	-3.442	9.363
-0.114	-12.506	-4.549	-7.775	-4.755	-2.067	-4.72	3.687	-3.417	9.381
-0.105	-12.513	-4.556	-7.774	-4.781	-2.06	-4.708	3.689	-3.399	9.404
-0.118	-12.516	-4.553	-7.765	-4.794	-2.031	-4.712	3.698	-3.401	9.401
-0.107	-12.506	-4.541	-7.738	-4.798	-2.025	-4.711	3.728	-3.42	9.42
-0.112	-12.512	-4.539	-7.731	-4.833	-2.021	-4.702	3.73	-3.407	9.443
-0.122	-12.517	-4.555	-7.728	-4.841	-1.991	-4.71	3.736	-3.422	9.44
-0.114	-12.506	-4.537	-7.696	-4.854	-1.985	-4.701	3.766	-3.449	9.451
-0.111	-12.51	-4.518	-7.689	-4.892	-1.982	-4.698	3.773	-3.455	9.478
-0.114	-12.517	-4.524	-7.689	-4.908	-1.956	-4.714	3.774	-3.478	9.475
-0.12	-12.509	-4.507	-7.659	-4.912	-1.946	-4.721	3.805	-3.502	9.488
-0.107	-12.506	-4.484	-7.65	-4.956	-1.949	-4.717	3.815	-3.491	9.518
-0.118	-12.517	-4.484	-7.65	-4.966	-1.921	-4.732	3.816	-3.517	9.517
-0.112	-12.512	-4.484	-7.624	-4.97	-1.911	-4.74	3.843	-3.539	9.523
-0.109	-12.506	-4.489	-7.607	-4.981	-1.913	-4.736	3.855	-3.525	9.555
-0.105	-12.515	-4.507	-7.611	-4.984	-1.887	-4.762	3.854	-3.534	9.56
-0.118	-12.513	-4.506	-7.588	-4.981	-1.871	-4.763	3.88	-3.541	9.564
-0.113	-12.505	-4.504	-7.569	-5.014	-1.872	-4.736	3.893	-3.537	9.593
-0.116	-12.515	-4.505	-7.573	-5.024	-1.853	-4.734	3.891	-3.533	9.598
-0.122	-12.515	-4.497	-7.55	-5.025	-1.83	-4.727	3.913	-3.533	9.601
-0.115	-12.505	-4.507	-7.525	-5.047	-1.832	-4.711	3.934	-3.482	9.629
-0.108	-12.513	-4.521	-7.528	-5.076	-1.814	-4.711	3.933	-3.473	9.639
-0.121	-12.517	-4.547	-7.514	-5.075	-1.792	-4.714	3.949	-3.513	9.637
-0.116	-12.506	-4.545	-7.488	-5.081	-1.794	-4.688	3.976	-3.532	9.665
-0.109	-12.511	-4.559	-7.488	-5.087	-1.777	-4.675	3.977	-3.542	9.679
-0.121	-12.517	-4.568	-7.48	-5.072	-1.752	-4.677	3.988	-3.567	9.677
-0.118	-12.508	-4.555	-7.451	-5.088	-1.752	-4.633	4.015	-3.564	9.698
-0.11	-12.509	-4.545	-7.45	-5.112	-1.743	-4.636	4.017	-3.549	9.719
-0.12	-12.516	-4.53	-7.441	-5.099	-1.714	-4.639	4.027	-3.554	9.716
-0.115	-12.511	-4.505	-7.418	-5.09	-1.712	-4.621	4.056	-3.552	9.735
-0.107	-12.508	-4.495	-7.409	-5.096	-1.706	-4.605	4.057	-3.555	9.757
-0.121	-12.516	-4.495	-7.405	-5.083	-1.675	-4.609	4.066	-3.577	9.751

Annex A

-0.115	-12.512	-4.474	-7.377	-5.08	-1.667	-4.591	4.095	-3.604	9.766
-0.108	-12.507	-4.467	-7.368	-5.097	-1.665	-4.583	4.099	-3.612	9.791
-0.112	-12.515	-4.469	-7.368	-5.085	-1.638	-4.591	4.104	-3.647	9.789
-0.126	-12.517	-4.474	-7.339	-5.087	-1.628	-4.564	4.132	-3.674	9.8
-0.116	-12.505	-4.468	-7.326	-5.109	-1.628	-4.545	4.144	-3.683	9.829
-0.104	-12.506	-4.497	-7.332	-5.067	-1.602	-4.542	4.143	-3.716	9.831
-0.124	-12.519	-4.508	-7.305	-5.046	-1.588	-4.527	4.17	-3.751	9.836
-0.116	-12.512	-4.476	-7.287	-5.053	-1.589	-4.486	4.183	-3.762	9.866
-0.109	-12.507	-4.505	-7.293	-5.043	-1.565	-4.478	4.183	-3.785	9.87
-0.116	-12.521	-4.513	-7.268	-5.031	-1.552	-4.469	4.207	-3.818	9.876
-0.125	-12.513	-4.489	-7.246	-5.054	-1.553	-4.453	4.22	-3.841	9.904
-0.105	-12.504	-4.473	-7.25	-5.055	-1.532	-4.457	4.222	-3.843	9.909
-0.111	-12.515	-4.469	-7.23	-5.035	-1.513	-4.452	4.243	-3.886	9.91
-0.121	-12.516	-4.443	-7.205	-5.033	-1.512	-4.435	4.265	-3.901	9.938
-0.109	-12.502	-4.432	-7.21	-5.051	-1.494	-4.433	4.263	-3.887	9.948
-0.11	-12.512	-4.432	-7.194	-5.046	-1.472	-4.422	4.279	-3.916	9.948
-0.12	-12.519	-4.408	-7.167	-5.058	-1.474	-4.39	4.303	-3.928	9.973
-0.112	-12.505	-4.402	-7.168	-5.054	-1.459	-4.394	4.301	-3.913	9.988
-0.106	-12.51	-4.403	-7.16	-5.032	-1.436	-4.384	4.313	-3.928	9.988
-0.126	-12.52	-4.404	-7.128	-5.02	-1.436	-4.248	4.339	-3.924	10.009
-0.114	-12.507	-4.386	-7.128	-5.029	-1.422	-3.78	4.341	-3.907	10.029
-0.108	-12.506	-4.394	-7.123	-5.024	-1.395	-3.872	4.348	-3.881	10.028
-0.117	-12.52	-4.387	-7.093	-5.025	-1.392	-3.891	4.375	-3.86	10.047
-0.112	-12.511	-4.371	-7.085	-5.038	-1.384	-3.917	4.375	-3.834	10.067
-0.109	-12.503	-4.377	-7.082	-5.038	-1.357	-3.935	4.385	-3.847	10.065
-0.116	-12.517	-4.356	-7.052	-5.045	-1.353	-3.919	4.409	-3.845	10.082
-0.147	-12.514	-4.335	-7.04	-5.072	-1.347	-3.9	4.417	-3.813	10.104
-0.206	-12.503	-4.333	-7.042	-5.068	-1.319	-3.911	4.421	-3.801	10.103
-0.292	-12.516	-4.328	-7.02	-5.077	-1.31	-3.915	4.451	-3.804	10.118
-0.424	-12.517	-4.301	-7.006	-5.105	-1.307	-3.893	4.458	-3.794	10.142
-0.553	-12.504	-4.308	-7.008	-5.116	-1.284	-3.85	4.461	-3.788	10.143
-0.876	-12.515	-4.293	-6.981	-5.093	-1.271	-3.817	4.487	-3.806	10.15
-1.252	-12.515	-4.264	-6.965	-5.116	-1.27	-3.797	4.501	-3.801	10.179
-1.449	-12.498	-4.272	-6.967	-5.117	-1.245	-3.806	4.5	-3.797	10.184
-1.428	-12.502	-4.275	-6.946	-5.121	-1.229	-3.807	4.523	-3.821	10.189
-1.536	-12.513	-4.261	-6.927	-5.124	-1.232	-3.777	4.536	-3.797	10.215
-1.665	-12.492	-4.255	-6.926	-5.112	-1.208	-3.786	4.539	-3.777	10.222
-1.778	-12.49	-4.256	-6.909	-5.087	-1.189	-3.763	4.559	-3.807	10.228
-1.893	-12.495	-4.25	-6.885	-5.104	-1.192	-3.738	4.581	-3.808	10.25
-1.991	-12.472	-4.253	-6.885	-5.116	-1.174	-3.743	4.581	-3.792	10.26
-2.069	-12.458	-4.263	-6.873	-5.105	-1.154	-3.751	4.594	-3.791	10.262

Annex A

-2.151	-12.465	-4.243	-6.846	-5.109	-1.153	-3.742	4.62	-3.767	10.288
-2.225	-12.446	-4.238	-6.847	-5.109	-1.14	-3.75	4.621	-3.755	10.304
-2.274	-12.429	-4.241	-6.839	-5.098	-1.117	-3.768	4.631	-3.757	10.301
-2.331	-12.433	-4.225	-6.809	-5.085	-1.112	-3.757	4.656	-3.744	10.324
-2.37	-12.418	-4.232	-6.806	-5.087	-1.101	-3.759	4.661	-3.728	10.341
-2.4	-12.396	-4.245	-6.802	-5.058	-1.077	-3.781	4.668	-3.751	10.342
-2.435	-12.396	-4.243	-6.773	-5.04	-1.074	-3.777	4.692	-3.749	10.36
-2.483	-12.387	-4.247	-6.763	-5.035	-1.065	-3.803	4.695	-3.733	10.382
-2.499	-12.359	-4.279	-6.764	-5.003	-1.036	-3.82	4.702	-3.757	10.383
-2.539	-12.358	-4.289	-6.732	-4.994	-1.03	-3.799	4.727	-3.753	10.395
-2.586	-12.354	-4.29	-6.724	-5.005	-1.024	-3.791	4.735	-3.748	10.418
-2.61	-12.325	-4.295	-6.724	-5.005	-1	-3.777	4.74	-3.757	10.421
-2.635	-12.317	-4.304	-6.696	-5.001	-0.989	-3.764	4.767	-3.758	10.431
-2.683	-12.323	-4.299	-6.685	-5.008	-0.986	-3.741	4.776	-3.753	10.456
-2.701	-12.295	-4.317	-6.688	-5.002	-0.963	-3.741	4.778	-3.75	10.46
-2.717	-12.282	-4.333	-6.662	-4.993	-0.951	-3.744	4.803	-3.765	10.469
-2.77	-12.285	-4.332	-6.644	-5.019	-0.947	-3.72	4.817	-3.741	10.495
-2.795	-12.261	-4.343	-6.649	-5.002	-0.925	-3.741	4.816	-3.681	10.502
-2.81	-12.245	-4.353	-6.629	-5.001	-0.913	-3.739	4.839	-3.461	10.513
-2.848	-12.248	-4.339	-6.605	-5.009	-0.906	-3.729	4.855	-3.502	10.536
-2.854	-12.226	-4.349	-6.606	-5.003	-0.884	-3.724	4.856	-3.51	10.54
-2.857	-12.205	-4.378	-6.593	-4.974	-0.866	-3.718	4.875	-3.523	10.545
-2.87	-12.21	-4.386	-6.567	-4.992	-0.866	-3.704	4.897	-3.505	10.568
-2.894	-12.196	-4.39	-6.567	-4.994	-0.85	-3.708	4.898	-3.503	10.579
-2.915	-12.169	-4.405	-6.554	-4.976	-0.827	-3.724	4.911	-3.538	10.583
-2.954	-12.174	-4.397	-6.531	-4.985	-0.826	-3.723	4.934	-3.557	10.604
-2.998	-12.161	-4.389	-6.528	-4.996	-0.814	-3.719	4.936	-3.562	10.62
-3.021	-12.135	-4.418	-6.523	-5.008	-0.789	-3.707	4.947	-3.593	10.622
-3.048	-12.133	-4.424	-6.491	-5.039	-0.789	-3.692	4.973	-3.594	10.641
-3.095	-12.129	-4.446	-6.486	-5.049	-0.779	-3.7	4.979	-3.588	10.661
-3.115	-12.1	-4.477	-6.483	-5.02	-0.753	-3.702	4.983	-3.608	10.661
-3.161	-12.1	-4.487	-6.455	-5.021	-0.748	-3.67	5.008	-3.615	10.678
-3.216	-12.095	-4.5	-6.443	-5.032	-0.739	-3.68	5.015	-3.612	10.699
-3.189	-12.067	-4.527	-6.444	-5.006	-0.713	-3.705	5.023	-3.616	10.704
-3.203	-12.057	-4.543	-6.417	-5.008	-0.707	-3.735	5.046	-3.632	10.713
-3.245	-12.06	-4.55	-6.404	-5.015	-0.702	-3.76	5.055	-3.627	10.737
-3.19	-12.036	-4.567	-6.403	-5.019	-0.677	-3.798	5.056	-3.633	10.74
-3.187	-12.019	-4.566	-6.381	-5.029	-0.663	-3.802	5.078	-3.646	10.752
-3.235	-12.023	-4.558	-6.364	-5.042	-0.664	-3.812	5.09	-3.644	10.775
-3.253	-12.003	-4.572	-6.366	-5.019	-0.64	-3.849	5.092	-3.637	10.781
-3.275	-11.983	-4.559	-6.344	-5.006	-0.625	-3.876	5.112	-3.62	10.79

Annex A

-3.278	-11.985	-4.55	-6.323	-4.994	-0.625	-3.897	5.128	-3.563	10.818
-3.317	-11.969	-4.562	-6.327	-4.996	-0.602	-3.934	5.131	-3.574	10.825
-3.324	-11.944	-4.581	-6.307	-4.97	-0.587	-3.965	5.147	-3.606	10.828
-3.332	-11.943	-4.572	-6.282	-4.95	-0.583	-3.959	5.167	-3.616	10.851
-3.354	-11.932	-4.589	-6.284	-4.944	-0.561	-3.949	5.169	-3.616	10.864
-3.354	-11.909	-4.597	-6.273	-4.926	-0.544	-3.969	5.183	-3.636	10.866
-3.324	-11.904	-4.581	-6.246	-4.928	-0.543	-3.951	5.205	-3.642	10.886
-3.333	-11.9	-4.584	-6.246	-4.92	-0.525	-3.977	5.208	-3.637	10.9
-3.333	-11.871	-4.603	-6.238	-4.913	-0.503	-4.002	5.223	-3.623	10.904
-3.35	-11.87	-4.58	-6.212	-4.899	-0.502	-3.993	5.246	-3.611	10.923
-3.389	-11.865	-4.576	-6.209	-4.887	-0.487	-4.003	5.25	-3.614	10.939
-3.397	-11.838	-4.599	-6.2	-4.879	-0.464	-4.027	5.26	-3.651	10.937
-3.387	-11.823	-4.59	-6.174	-4.901	-0.461	-4.017	5.284	-3.659	10.956
-3.425	-11.824	-4.595	-6.166	-4.916	-0.449	-4.035	5.288	-3.666	10.976
-3.441	-11.805	-4.619	-6.166	-4.908	-0.427	-4.051	5.294	-3.675	10.976
-3.419	-11.786	-4.599	-6.139	-4.906	-0.418	-4.018	5.319	-3.699	10.99
-3.446	-11.788	-4.602	-6.123	-4.903	-0.412	-4.001	5.331	-3.706	11.012
-3.449	-11.769	-4.604	-6.124	-4.886	-0.388	-3.977	5.336	-3.726	11.017
-3.451	-11.748	-4.599	-6.098	-4.892	-0.382	-3.923	5.359	-3.747	11.025
-3.323	-11.749	-4.59	-6.082	-4.914	-0.377	-3.91	5.373	-3.731	11.049
-3.338	-11.734	-4.596	-6.083	-4.898	-0.351	-3.899	5.372	-3.739	11.054
-3.319	-11.712	-4.601	-6.063	-4.885	-0.339	-3.88	5.4	-3.755	11.065
-3.317	-11.709	-4.579	-6.045	-4.895	-0.34	-3.866	5.415	-3.763	11.087
-3.343	-11.701	-4.591	-6.047	-4.901	-0.315	-3.865	5.415	-3.775	11.095
-3.354	-11.673	-4.585	-6.027	-4.893	-0.298	-3.853	5.437	-3.78	11.099
-3.365	-11.67	-4.575	-6.007	-4.916	-0.3	-3.832	5.455	-3.757	11.125
-3.361	-11.664	-4.602	-6.007	-4.927	-0.279	-3.831	5.452	-3.775	11.135
-3.344	-11.638	-4.615	-5.993	-4.934	-0.264	-3.798	5.471	-3.782	11.139
-3.331	-11.63	-4.629	-5.965	-4.976	-0.26	-3.768	5.491	-3.776	11.163
-3.367	-11.628	-4.652	-5.965	-4.995	-0.242	-3.753	5.492	-3.765	11.176
-3.378	-11.607	-4.654	-5.952	-5.008	-0.22	-3.732	5.508	-3.761	11.176
-3.384	-11.591	-4.653	-5.928	-5.043	-0.219	-3.711	5.529	-3.753	11.198
-3.427	-11.59	-4.666	-5.924	-5.066	-0.2	-3.706	5.532	-3.725	11.214
-3.46	-11.568	-4.687	-5.916	-5.07	-0.182	-3.694	5.548	-3.739	11.217
-3.502	-11.553	-4.677	-5.893	-5.086	-0.18	-3.657	5.571	-3.744	11.237
-3.54	-11.554	-4.692	-5.884	-5.119	-0.168	-3.652	5.574	-3.749	11.254
-3.547	-11.534	-4.702	-5.884	-5.122	-0.143	-3.648	5.586	-3.779	11.254
-3.548	-11.514	-4.695	-5.859	-5.132	-0.141	-3.624	5.608	-3.8	11.272
-3.59	-11.514	-4.69	-5.849	-5.152	-0.131	-3.626	5.614	-3.816	11.293
-3.622	-11.5	-4.709	-5.847	-5.15	-0.104	-3.643	5.62	-3.811	11.295
-3.639	-11.476	-4.693	-5.821	-5.177	-0.097	-3.631	5.646	-3.818	11.308

Annex A

-3.66	-11.473	-4.695	-5.805	-5.217	-0.094	-3.626	5.657	-3.823	11.329
-3.655	-11.469	-4.708	-5.807	-5.219	-0.065	-3.632	5.66	-3.833	11.331
-3.669	-11.444	-4.714	-5.783	-5.213	-0.058	-3.629	5.686	-3.825	11.339
-3.692	-11.437	-4.716	-5.766	-5.21	-0.051	-3.647	5.698	-3.795	11.366
-3.727	-11.431	-4.731	-5.766	-5.212	-0.026	-3.667	5.701	-3.78	11.371
-3.735	-11.406	-4.731	-5.749	-5.216	-0.016	-3.654	5.722	-3.794	11.377
-3.76	-11.394	-4.715	-5.726	-5.245	-0.017	-3.655	5.738	-3.766	11.404
-3.796	-11.396	-4.723	-5.728	-5.238	0.005	-3.66	5.74	-3.748	11.411
-3.806	-11.368	-4.712	-5.71	-5.236	0.022	-3.644	5.761	-3.737	11.416
-3.797	-11.356	-4.695	-5.688	-5.255	0.018	-3.617	5.782	-3.721	11.443
-3.784	-11.357	-4.683	-5.686	-5.256	0.043	-3.639	5.778	-3.716	11.455
-3.81	-11.336	-4.683	-5.672	-5.229	0.062	-3.65	5.798	-3.732	11.455
-3.8	-11.32	-4.663	-5.645	-5.229	0.062	-3.657	5.818	-3.75	11.481
-3.809	-11.323	-4.668	-5.641	-5.217	0.079	-3.677	5.818	-3.587	11.498
-3.816	-11.304	-4.662	-5.636	-5.198	0.101	-3.691	5.833	-3.607	11.496
-3.816	-11.28	-4.656	-5.61	-5.18	0.1	-3.682	5.856	-3.616	11.518
-3.846	-11.283	-4.661	-5.601	-5.152	0.118	-3.711	5.859	-3.623	11.534
-3.861	-11.268	-4.685	-5.597	-5.094	0.142	-3.72	5.871	-3.643	11.533
-3.85	-11.244	-4.686	-5.572	-5.059	0.143	-3.725	5.892	-3.614	11.552
-3.866	-11.242	-4.683	-5.562	-5.047	0.156	-3.712	5.895	-3.554	11.576
-3.884	-11.232	-4.689	-5.561	-5.018	0.182	-3.697	5.907	-3.594	11.576
-3.869	-11.207	-4.685	-5.535	-5	0.181	-3.705	5.932	-3.607	11.591
-3.859	-11.201	-4.68	-5.523	-4.992	0.192	-3.721	5.935	-3.606	11.614
-3.883	-11.198	-4.693	-5.522	-4.965	0.219	-3.743	5.943	-3.615	11.614
-3.883	-11.169	-4.706	-5.496	-4.957	0.225	-3.746	5.97	-3.639	11.626
-3.876	-11.159	-4.7	-5.481	-4.956	0.23	-3.768	5.977	-3.65	11.652
-3.881	-11.16	-4.721	-5.485	-4.927	0.26	-3.809	5.981	-3.681	11.652
-3.865	-11.129	-4.733	-5.464	-4.908	0.265	-3.82	6.007	-3.709	11.661
-3.853	-11.118	-4.731	-5.443	-4.902	0.271	-3.816	6.018	-3.715	11.689
-3.859	-11.12	-4.737	-5.441	-4.884	0.298	-3.833	6.019	-3.733	11.691
-3.864	-11.097	-4.739	-5.429	-4.857	0.308	-3.832	6.046	-3.747	11.7
-3.875	-11.077	-4.734	-5.403	-4.852	0.308	-3.819	6.058	-3.754	11.723
-3.909	-11.082	-4.725	-5.405	-4.826	0.336	-3.842	6.057	-3.762	11.728
-3.927	-11.061	-4.743	-5.393	-4.81	0.35	-3.849	6.082	-3.787	11.73
-3.927	-11.037	-4.742	-5.368	-4.805	0.345	-3.838	6.1	-3.798	11.759
-3.945	-11.041	-4.747	-5.363	-4.781	0.371	-3.864	6.095	-3.785	11.768
-3.94	-11.026	-4.773	-5.357	-4.758	0.384	-3.853	6.119	-3.806	11.767
-3.942	-11	-4.779	-5.328	-4.75	0.383	-3.838	6.139	-3.831	11.796
-3.953	-11.005	-4.782	-5.322	-4.735	0.405	-3.809	6.136	-3.816	11.806
-3.974	-10.992	-4.795	-5.318	-4.711	0.429	-3.797	6.154	-3.829	11.803
-4.001	-10.962	-4.806	-5.288	-4.699	0.425	-3.791	6.178	-3.828	11.828

Annex A

-4.012	-10.961	-4.8	-5.282	-4.689	0.446	-3.791	6.181	-3.811	11.847
-4.048	-10.959	-4.82	-5.281	-4.676	0.466	-3.785	6.194	-3.826	11.846
-4.05	-10.928	-4.823	-5.253	-4.672	0.466	-3.77	6.218	-3.824	11.865
-4.06	-10.922	-4.823	-5.241	-4.688	0.48	-3.761	6.221	-3.812	11.886
-4.092	-10.92	-4.839	-5.242	-4.666	0.505	-3.748	6.233	-3.817	11.885
-4.087	-10.892	-4.848	-5.217	-4.647	0.505	-3.744	6.251	-3.814	11.901
-4.063	-10.884	-4.843	-5.201	-4.65	0.516	-3.742	6.254	-3.781	11.926
-4.083	-10.882	-4.868	-5.203	-4.642	0.542	-3.723	6.262	-3.769	11.926
-4.083	-10.855	-4.873	-5.18	-4.646	0.549	-3.696	6.292	-3.773	11.94
-4.069	-10.842	-4.87	-5.159	-4.664	0.556	-3.682	6.296	-3.78	11.963
-4.089	-10.847	-4.865	-5.162	-4.658	0.582	-3.691	6.301	-3.777	11.965
-4.09	-10.823	-4.868	-5.143	-4.663	0.589	-3.672	6.328	-3.806	11.972
-4.075	-10.802	-4.855	-5.12	-4.662	0.594	-3.647	6.341	-3.799	11.999
-4.068	-10.804	-4.862	-5.121	-4.649	0.621	-3.635	6.341	-3.789	12.004
-4.047	-10.784	-4.874	-5.109	-4.63	0.631	-3.598	6.369	-3.787	12.01
-4.01	-10.758	-4.863	-5.082	-4.652	0.628	-3.538	6.379	-3.766	12.038
-3.974	-10.761	-4.86	-5.085	-4.671	0.659	-3.516	6.383	-3.742	12.046
-3.974	-10.748	-4.878	-5.077	-4.67	0.671	-3.487	6.406	-3.762	12.049
-3.941	-10.721	-4.858	-5.048	-4.701	0.668	-3.461	6.423	-3.769	12.075
-3.913	-10.721	-4.838	-5.042	-4.733	0.693	-3.462	6.42	-3.786	12.085
-3.891	-10.708	-4.837	-5.039	-4.745	0.708	-3.449	6.443	-3.808	12.088
-3.881	-10.682	-4.817	-5.008	-4.788	0.707	-3.43	6.46	-3.802	12.109
-3.885	-10.68	-4.809	-4.999	-4.818	0.731	-3.427	6.458	-3.795	12.119
-3.903	-10.672	-4.82	-5.001	-4.817	0.749	-3.416	6.48	-3.815	12.118
-3.892	-10.645	-4.797	-4.972	-4.821	0.748	-3.404	6.499	-3.838	12.142
-3.887	-10.635	-4.783	-4.96	-4.842	0.768	-3.428	6.5	-3.834	12.156
-3.885	-10.634	-4.787	-4.961	-4.874	0.785	-3.446	6.517	-3.848	12.154
-3.888	-10.605	-4.772	-4.937	-4.905	0.784	-3.447	6.542	-3.828	12.175
-3.869	-10.594	-4.75	-4.92	-4.955	0.798	-3.451	6.541	-3.798	12.198
-3.877	-10.596	-4.766	-4.925	-4.984	0.825	-3.486	6.554	-3.792	12.198
-3.869	-10.573	-4.754	-4.9	-5.019	0.82	-3.51	6.577	-3.784	12.214
-3.844	-10.558	-4.752	-4.878	-5.056	0.834	-3.515	6.581	-3.763	12.238
-3.881	-10.56	-4.771	-4.881	-5.069	0.862	-3.543	6.588	-3.736	12.238
-3.887	-10.541	-4.761	-4.861	-5.078	0.863	-3.558	6.616	-3.673	12.252
-3.884	-10.521	-4.757	-4.837	-5.106	0.87	-3.561	6.619	-3.646	12.277
-3.912	-10.518	-4.767	-4.843	-5.096	0.899	-3.584	6.622	-3.636	12.279
-3.925	-10.507	-4.789	-4.824	-5.095	0.904	-3.596	6.648	-3.64	12.288
-3.905	-10.48	-4.781	-4.799	-5.11	0.91	-3.6	6.656	-3.608	12.315
-3.891	-10.479	-4.767	-4.802	-5.086	0.939	-3.598	6.659	-3.61	12.317
-3.884	-10.468	-4.768	-4.789	-5.075	0.946	-3.594	6.685	-3.585	12.324
-3.865	-10.442	-4.756	-4.761	-5.081	0.949	-3.588	6.695	-3.556	12.352

Annex A

-3.858	-10.438	-4.75	-4.76	-5.065	0.978	-3.6	6.698	-3.556	12.362
-3.868	-10.432	-4.76	-4.754	-5.043	0.987	-3.607	6.723	-3.564	12.364
-3.851	-10.403	-4.758	-4.726	-5.056	0.986	-3.591	6.737	-3.558	12.393
-3.851	-10.396	-4.759	-4.718	-5.045	1.013	-3.606	6.734	-3.582	12.402
-3.869	-10.395	-4.768	-4.715	-5.041	1.027	-3.595	6.761	-3.631	12.402
-3.851	-10.366	-4.757	-4.691	-5.053	1.025	-3.585	6.777	-3.629	12.424
-3.826	-10.358	-4.744	-4.683	-5.043	1.051	-3.615	6.774	-3.637	12.439
-3.832	-10.353	-4.757	-4.683	-5.029	1.073	-3.611	6.796	-3.686	12.436
-3.836	-10.332	-4.761	-4.656	-5.025	1.068	-3.598	6.817	-3.666	12.46
-3.823	-10.316	-4.753	-4.642	-5.004	1.09	-3.624	6.815	-3.679	12.476
-3.826	-10.315	-4.778	-4.648	-4.969	1.112	-3.637	6.834	-3.725	12.473
-3.817	-10.292	-4.78	-4.62	-4.967	1.109	-3.61	6.855	-3.753	12.49
-3.807	-10.275	-4.76	-4.604	-4.93	1.13	-3.616	6.856	-3.758	12.507
-3.818	-10.276	-4.773	-4.61	-4.902	1.153	-3.632	6.872	-3.785	12.506
-3.847	-10.259	-4.779	-4.585	-4.913	1.15	-3.629	6.896	-3.762	12.523
-3.863	-10.238	-4.766	-4.562	-4.916	1.161	-3.625	6.895	-3.716	12.546
-3.903	-10.238	-4.783	-4.566	-4.907	1.186	-3.629	6.909	-3.738	12.548
-3.939	-10.227	-4.817	-4.548	-4.911	1.187	-3.628	6.933	-3.762	12.562
-3.94	-10.202	-4.81	-4.525	-4.925	1.198	-3.641	6.932	-3.763	12.582
-3.972	-10.194	-4.833	-4.525	-4.896	1.228	-3.674	6.942	-3.769	12.586
-4.003	-10.19	-4.867	-4.509	-4.87	1.233	-3.679	6.97	-3.778	12.596
-4.006	-10.164	-4.862	-4.485	-4.883	1.238	-3.663	6.978	-3.765	12.622
-4.005	-10.155	-4.86	-4.486	-4.878	1.265	-3.671	6.98	-3.787	12.622
-4.026	-10.154	-4.885	-4.48	-4.864	1.272	-3.644	7.01	-3.805	12.632
-4.042	-10.128	-4.887	-4.448	-4.872	1.276	-3.637	7.016	-3.804	12.657
-4.033	-10.118	-4.911	-4.446	-4.859	1.305	-3.669	7.016	-3.805	12.665
-4.048	-10.119	-4.922	-4.44	-4.841	1.312	-3.663	7.04	-3.825	12.668
-4.065	-10.095	-4.913	-4.411	-4.839	1.311	-3.628	7.053	-3.826	12.694
-4.062	-10.077	-4.909	-4.402	-4.789	1.341	-3.641	7.055	-3.815	12.703
-4.082	-10.078	-4.943	-4.401	-4.751	1.355	-3.634	7.079	-3.809	12.707
-4.103	-10.06	-4.95	-4.371	-4.712	1.356	-3.624	7.093	-3.802	12.73
-4.135	-10.04	-4.962	-4.363	-4.66	1.38	-3.651	7.091	-3.776	12.741
-4.182	-10.039	-4.987	-4.361	-4.595	1.401	-3.641	7.116	-3.804	12.742
-4.222	-10.025	-5.001	-4.335	-4.569	1.397	-3.625	7.132	-3.8	12.766
-4.254	-10.002	-5	-4.324	-4.551	1.419	-3.638	7.13	-3.792	12.781
-4.293	-9.999	-5.016	-4.326	-4.533	1.438	-3.638	7.152	-3.808	12.782
-4.324	-9.987	-5.029	-4.305	-4.533	1.435	-3.624	7.176	-3.812	12.803
-4.33	-9.964	-5.017	-4.289	-4.547	1.455	-3.64	7.172	-3.806	12.822
-4.338	-9.963	-5.025	-4.29	-4.535	1.476	-3.666	7.189	-3.802	12.822
-4.368	-9.957	-5.016	-4.268	-4.539	1.473	-3.664	7.213	-3.784	12.84
-4.338	-9.928	-4.994	-4.244	-4.56	1.489	-3.677	7.211	-3.759	12.861

Annex A

-4.305	-9.923	-4.995	-4.246	-4.543	1.516	-3.71	7.225	-3.781	12.863
-4.261	-9.916	-4.998	-4.231	-4.53	1.517	-3.722	7.247	-3.797	12.878
-4.203	-9.89	-4.991	-4.207	-4.541	1.527	-3.744	7.252	-3.788	12.893
-4.204	-9.875	-5	-4.207	-4.522	1.555	-3.75	7.261	-3.766	12.898
-4.246	-9.878	-5.03	-4.195	-4.531	1.555	-3.735	7.288	-3.756	12.911
-4.258	-9.851	-5.018	-4.17	-4.547	1.561	-3.739	7.294	-3.744	12.933
-4.276	-9.839	-5.024	-4.168	-4.539	1.591	-3.756	7.301	-3.735	12.937
-4.285	-9.84	-5.031	-4.158	-4.525	1.597	-3.751	7.328	-3.739	12.947
-4.304	-9.819	-5.012	-4.131	-4.545	1.597	-3.743	7.333	-3.7	12.974
-4.321	-9.8	-5.016	-4.128	-4.532	1.625	-3.767	7.338	-3.681	12.979
-4.345	-9.802	-5.018	-4.122	-4.526	1.637	-3.789	7.364	-3.679	12.984
-4.361	-9.784	-5.013	-4.094	-4.553	1.635	-3.798	7.375	-3.657	13.012
-4.357	-9.762	-4.998	-4.083	-4.542	1.664	-3.828	7.375	-3.637	13.021
-4.381	-9.764	-5.014	-4.085	-4.528	1.675	-3.829	7.401	-3.628	13.026
-4.4	-9.753	-5.005	-4.057	-4.549	1.674	-3.833	7.412	-3.596	13.05
-4.392	-9.725	-4.989	-4.042	-4.546	1.7	-3.849	7.41	-3.583	13.062
-4.398	-9.726	-5.008	-4.043	-4.54	1.72	-3.637	7.435	-3.608	13.063
-4.404	-9.717	-4.994	-4.019	-4.581	1.718	-3.682	7.45	-3.601	13.086
-4.403	-9.689	-4.976	-4.004	-4.601	1.736	-3.715	7.45	-3.564	13.1
-4.407	-9.683	-4.996	-4.005	-4.568	1.758	-3.733	7.47	-3.579	13.1
-4.443	-9.681	-4.989	-3.981	-4.58	1.758	-3.723	7.493	-3.571	13.123
-4.445	-9.656	-4.981	-3.963	-4.608	1.77	-3.743	7.488	-3.553	13.14
-4.441	-9.646	-4.981	-3.965	-4.602	1.796	-3.742	7.507	-3.555	13.141
-4.441	-9.647	-4.996	-3.946	-4.619	1.793	-3.713	7.526	-3.555	13.16
-4.423	-9.616	-4.984	-3.924	-4.631	1.81	-3.727	7.529	-3.534	13.183
-4.403	-9.606	-4.984	-3.924	-4.617	1.833	-3.746	7.544	-3.546	13.182
-4.398	-9.607	-4.982	-3.909	-4.597	1.838	-3.746	7.568	-3.543	13.198
-4.388	-9.581	-4.959	-3.885	-4.615	1.849	-3.75	7.566	-3.523	13.218
-4.38	-9.562	-4.968	-3.884	-4.607	1.876	-3.766	7.58	-3.513	13.222
-4.389	-9.565	-4.965	-3.872	-4.603	1.879	-3.729	7.606	-3.515	13.235
-4.381	-9.543	-4.937	-3.849	-4.63	1.885	-3.699	7.611	-3.492	13.257
-4.365	-9.523	-4.921	-3.845	-4.657	1.913	-3.706	7.619	-3.486	13.26
-4.366	-9.525	-4.929	-3.836	-4.689	1.919	-3.692	7.646	-3.467	13.267
-4.367	-9.509	-4.916	-3.812	-4.744	1.924	-3.68	7.654	-3.44	13.292
-4.339	-9.485	-4.924	-3.803	-4.77	1.944	-3.687	7.657	-3.443	13.301
-4.337	-9.486	-4.953	-3.799	-4.789	1.953	-3.669	7.683	-3.468	13.307
-4.322	-9.473	-4.946	-3.771	-4.824	1.955	-3.644	7.693	-3.461	13.331
-4.298	-9.446	-4.948	-3.76	-4.824	1.979	-3.667	7.697	-3.473	13.34
-4.294	-9.446	-4.98	-3.76	-4.83	1.993	-3.661	7.719	-3.491	13.346
-4.308	-9.436	-4.995	-3.737	-4.868	1.995	-3.642	7.732	-3.488	13.368
-4.287	-9.406	-5.014	-3.718	-4.883	2.016	-3.659	7.734	-3.477	13.381

Annex A

-4.287	-9.403	-5.041	-3.721	-4.892	2.037	-3.641	7.756	-3.475	13.383
-4.299	-9.4	-5.063	-3.703	-4.918	2.033	-3.626	7.77	-3.451	13.404
-4.299	-9.374	-5.056	-3.682	-4.897	2.053	-3.625	7.773	-3.439	13.419
-4.285	-9.367	-5.106	-3.682	-4.914	2.075	-3.625	7.795	-3.438	13.419
-4.278	-9.368	-5.12	-3.668	-4.948	2.075	-3.6	7.808	-3.427	13.441
-4.26	-9.342	-5.141	-3.646	-4.994	2.086	-3.62	7.806	-3.42	13.461
-4.253	-9.33	-5.152	-3.642	-4.999	2.11	-3.622	7.825	-3.417	13.461
-4.264	-9.329	-5.155	-3.627	-5.037	2.111	-3.603	7.847	-3.426	13.478
-4.248	-9.306	-5.108	-3.602	-5.056	2.124	-3.597	7.847	-3.428	13.5
-4.222	-9.289	-5.051	-3.598	-5.041	2.148	-3.598	7.861	-3.437	13.5
-4.229	-9.292	-5.055	-3.588	-5.062	2.151	-3.58	7.884	-3.462	13.513
-4.22	-9.268	-5.02	-3.562	-5.079	2.16	-3.571	7.887	-3.481	13.536
-4.217	-9.247	-5.017	-3.559	-5.071	2.19	-3.549	7.897	-3.503	13.54
-4.222	-9.251	-5.039	-3.55	-5.064	2.194	-3.504	7.922	-3.513	13.551
-4.223	-9.231	-5.02	-3.526	-5.075	2.2	-3.497	7.928	-3.52	13.573
-4.201	-9.209	-4.998	-3.519	-5.065	2.225	-3.506	7.936	-3.53	13.579
-4.222	-9.213	-4.999	-3.515	-5.05	2.234	-3.492	7.966	-3.548	13.588
-4.252	-9.199	-4.989	-3.492	-5.06	2.237	-3.49	7.969	-3.533	13.61
-4.234	-9.174	-4.997	-3.479	-5.047	2.262	-3.504	7.977	-3.524	13.617
-4.231	-9.174	-5.023	-3.475	-5.028	2.273	-3.497	8.001	-3.55	13.622
-4.251	-9.163	-4.991	-3.451	-5.006	2.278	-3.483	8.009	-3.558	13.648
-4.245	-9.135	-4.968	-3.437	-4.984	2.3	-3.507	8.012	-3.586	13.656
-4.267	-9.131	-4.977	-3.436	-4.992	2.315	-3.517	8.036	-3.613	13.656
-4.276	-9.126	-4.966	-3.415	-5.029	2.315	-3.531	8.05	-3.613	13.68
-4.262	-9.095	-4.942	-3.396	-5.027	2.335	-3.575	8.05	-3.63	13.69
-4.265	-9.088	-4.952	-3.397	-5.006	2.352	-3.58	8.075	-3.657	13.694
-4.284	-9.088	-4.971	-3.38	-5.008	2.353	-3.583	8.089	-3.665	13.714
-4.283	-9.062	-4.969	-3.358	-5.001	2.373	-3.607	8.091	-3.657	13.73
-4.275	-9.048	-4.967	-3.356	-4.983	2.394	-3.617	8.11	-3.686	13.73
-4.306	-9.052	-4.957	-3.339	-5.003	2.396	-3.623	8.13	-3.696	13.751
-4.297	-9.026	-4.932	-3.318	-4.995	2.406	-3.652	8.13	-3.691	13.764
-4.266	-9.01	-4.933	-3.315	-4.989	2.432	-3.677	8.148	-3.725	13.765
-4.286	-9.011	-4.935	-3.304	-4.531	2.437	-3.612	8.167	-3.732	13.785
-4.277	-8.992	-4.931	-3.277	-4.437	2.451	-3.591	8.172	-3.731	13.806
-4.254	-8.974	-4.95	-3.272	-4.426	2.475	-3.617	8.183	-3.728	13.806
-4.267	-8.976	-4.956	-3.265	-4.425	2.482	-3.625	8.202	-3.731	13.821
-4.279	-8.954	-4.954	-3.238	-4.436	2.487	-3.658	8.204	-3.724	13.843
-4.275	-8.933	-4.954	-3.231	-4.424	2.515	-3.668	8.217	-3.728	13.846
-4.286	-8.934	-4.976	-3.228	-4.408	2.524	-3.644	8.24	-3.729	13.857
-4.316	-8.919	-4.977	-3.204	-4.388	2.528	-3.647	8.244	-3.716	13.88
-4.32	-8.895	-4.977	-3.191	-4.37	2.554	-3.655	8.253	-3.718	13.882

Annex A

-4.319	-8.897	-4.986	-3.19	-4.345	2.564	-3.65	8.281	-3.72	13.891
-4.331	-8.885	-4.982	-3.168	-4.385	2.565	-3.679	8.286	-3.718	13.916
-4.326	-8.859	-4.976	-3.15	-4.39	2.59	-3.707	8.29	-3.74	13.923
-4.322	-8.854	-4.989	-3.15	-4.386	2.602	-3.719	8.315	-3.748	13.93
-4.332	-8.848	-4.976	-3.131	-4.4	2.604	-3.73	8.325	-3.719	13.956
-4.309	-8.822	-4.953	-3.116	-4.381	2.628	-3.753	8.325	-3.7	13.963
-4.3	-8.811	-4.982	-3.117	-4.366	2.647	-3.742	8.35	-3.699	13.966
-4.314	-8.809	-5.002	-3.095	-4.365	2.647	-3.676	8.367	-3.678	13.993
-4.323	-8.782	-5.009	-3.076	-4.354	2.665	-3.689	8.365	-3.683	14.003
-4.327	-8.772	-5.022	-3.077	-4.327	2.687	-3.676	8.388	-3.67	14.005
-4.355	-8.772	-5.022	-3.063	-4.328	2.687	-3.651	8.404	-3.659	14.028
-4.384	-8.747	-5.006	-3.037	-4.307	2.706	-3.634	8.406	-3.667	14.041
-4.382	-8.735	-5.015	-3.039	-4.271	2.728	-3.618	8.429	-3.688	14.04
-4.416	-8.737	-5.025	-3.025	-4.264	2.727	-3.599	8.446	-3.717	14.055
-4.417	-8.711	-5.023	-3.002	-4.259	2.734	-3.585	8.446	-3.743	14.071
-4.395	-8.691	-5.023	-2.996	-4.242	2.759	-3.555	8.468	-3.779	14.074
-4.394	-8.695	-5.034	-2.986	-4.227	2.762	-3.561	8.489	-3.801	14.094
-4.399	-8.676	-5.029	-2.962	-4.243	2.773	-3.575	8.487	-3.806	14.114
-4.404	-8.653	-5.026	-2.954	-4.255	2.797	-3.585	8.499	-3.818	14.112
-4.421	-8.653	-5.037	-2.949	-4.261	2.806	-3.583	8.525	-3.816	14.131
-4.427	-8.64	-5.034	-2.922	-4.255	2.813	-3.594	8.527	-3.809	14.151
-4.425	-8.615	-5.022	-2.915	-4.248	2.838	-3.611	8.538	-3.805	14.15
-4.42	-8.613	-5.028	-2.91	-4.237	2.845	-3.612	8.561	-3.837	14.163
-4.442	-8.603	-5.029	-2.886	-4.257	2.851	-3.606	8.566	-3.83	14.188
-4.43	-8.578	-5.021	-2.873	-4.263	2.877	-3.587	8.576	-3.802	14.192
-4.446	-8.577	-5.041	-2.874	-4.266	2.886	-3.55	8.601	-3.791	14.202
-4.45	-8.569	-5.046	-2.85	-4.3	2.887	-3.538	8.605	-3.779	14.228
-4.44	-8.541	-5.047	-2.831	-4.305	2.911	-3.547	8.611	-3.768	14.234
-4.447	-8.537	-5.069	-2.831	-4.286	2.929	-3.538	8.638	-3.761	14.238
-4.459	-8.531	-5.082	-2.815	-4.288	2.928	-3.544	8.646	-3.739	14.266
-4.466	-8.505	-5.1	-2.792	-4.302	2.948	-3.574	8.647	-3.722	14.272
-4.459	-8.494	-5.128	-2.792	-4.294	2.967	-3.553	8.675	-3.707	14.278
-4.462	-8.491	-5.131	-2.777	-4.314	2.968	-3.543	8.687	-3.698	14.305
-4.457	-8.468	-5.131	-2.753	-4.334	2.982	-3.562	8.688	-3.688	14.317
-4.432	-8.454	-5.161	-2.756	-4.336	3.007	-3.549	8.709	-3.692	14.315
-4.447	-8.453	-5.186	-2.745	-4.324	3.01	-3.55	8.725	-3.699	14.34
-4.455	-8.43	-5.19	-2.718	-4.314	3.024	-3.555	8.727	-3.68	14.355
-4.461	-8.415	-5.224	-2.721	-4.311	3.047	-3.566	8.748	-3.701	14.353
-4.471	-8.416	-5.236	-2.709	-4.313	3.047	-3.568	8.768	-3.71	14.377
-4.479	-8.398	-5.226	-2.681	-4.331	3.059	-3.574	8.764	-3.704	14.393
-4.474	-8.376	-5.233	-2.679	-4.339	3.086	-3.579	8.786	-3.728	14.391

Annex A

-4.502	-8.375	-5.246	-2.673	-4.35	3.089	-3.535	8.806	-3.735	14.414
-4.517	-8.363	-5.256	-2.642	-4.35	3.098	-3.546	8.807	-3.749	14.432
-4.477	-8.337	-5.253	-2.637	-4.364	3.12	-3.548	8.819	-3.757	14.429
-4.481	-8.333	-5.255	-2.632	-4.359	3.124	-3.551	8.845	-3.775	14.447
-4.493	-8.323	-5.239	-2.605	-4.35	3.128	-3.576	8.844	-3.778	14.467
-4.493	-8.297	-5.217	-2.597	-4.337	3.157	-3.585	8.857	-3.791	14.466
-4.506	-8.294	-5.227	-2.597	-4.334	3.166	-3.585	8.882	-3.791	14.481
-4.503	-8.285	-5.224	-2.569	-4.389	3.169	-3.58	8.888	-3.773	14.505
-4.497	-8.262	-5.196	-2.557	-4.407	3.196	-3.603	8.892	-3.788	14.505
-4.5	-8.253	-5.197	-2.555	-4.413	3.206	-3.607	8.921	-3.811	14.516
-4.51	-8.25	-5.184	-2.533	-4.446	3.206	-3.638	8.927	-3.811	14.541
-4.503	-8.225	-5.162	-2.513	-4.465	3.229	-3.656	8.933	-3.816	14.544
-4.488	-8.214	-5.172	-2.516	-4.477	3.246	-3.654	8.96	-3.836	14.553
-4.492	-8.213	-5.167	-2.494	-4.527	3.243	-3.65	8.967	-3.841	14.58
-4.491	-8.19	-5.148	-2.471	-4.555	3.265	-3.65	8.968	-3.869	14.584
-4.478	-8.171	-5.134	-2.472	-4.56	3.286	-3.638	8.993	-3.922	14.59
-4.484	-8.172	-5.128	-2.454	-4.588	3.286	-3.626	9.005	-3.92	14.614
-4.485	-8.153	-5.091	-2.43	-4.587	3.3	-3.64	9.004	-3.927	14.622
-4.46	-8.134	-5.083	-2.433	-4.569	3.324	-3.637	9.028	-3.955	14.625
-4.459	-8.133	-5.082	-2.42	-4.59	3.324	-3.642	9.044	-3.84	14.647
-4.461	-8.117	-5.059	-2.393	-4.609	3.339	-3.664	9.044	-3.742	14.649
-4.461	-8.095	-5.041	-2.393	-4.607	3.364	-3.631	9.066	-3.715	14.646
-4.465	-8.095	-5.021	-2.382	-4.626	3.368	-3.573	9.088	-3.692	14.652
-4.463	-8.081	-4.989	-2.354	-4.646	3.372	-3.48	9.084	-3.67	14.65
-4.443	-8.056	-4.974	-2.351	-4.645	3.402	-3.488	9.105	-3.632	14.647
-4.443	-8.052	-4.977	-2.348	-4.658	3.405	-3.493	9.127	-3.62	14.643
-4.423	-8.043	-4.943	-2.318	-4.67	3.411	-3.494	9.124	-3.599	14.652
-4.422	-8.016	-4.942	-2.307	-4.667	3.44	-3.487	9.134	-3.586	14.648
-4.433	-8.009	-4.942	-2.307	-4.668	3.448	-3.474	9.162	-3.587	14.646
-4.456	-8.005	-4.928	-2.28	-4.677	3.452	-3.471	9.163	-3.571	14.648
-4.449	-7.977	-4.907	-2.267	-4.679	3.479	-3.491	9.173	-3.561	14.647
-4.453	-7.97	-4.9	-2.27	-4.679	3.49	-3.497	9.199	-3.555	14.65
-4.467	-7.966	-4.893	-2.242	-4.697	3.49	-3.505	9.203	-3.553	14.65
-4.477	-7.943	-4.859	-2.23	-4.706	3.513	-3.471	9.212	-3.552	14.643
-4.477	-7.93	-4.858	-2.232	-4.705	3.525	-3.455	9.241	-3.54	14.649
-4.481	-7.929	-4.852	-2.208	-4.723	3.526	-3.495	9.242	-3.527	14.653
-4.469	-7.906	-4.823	-2.187	-4.735	3.549	-3.517	9.249	-3.535	14.642
-4.472	-7.891	-4.81	-2.191	-4.725	3.562	-3.518	9.279	-3.534	14.647
-4.486	-7.89	-4.796	-2.169	-4.756	3.563	-3.508	9.283	-3.518	14.656
-4.496	-7.867	-4.746	-2.145	-4.772	3.583	-3.52	9.283	-3.52	14.644
-4.508	-7.851	-4.713	-2.148	-4.753	3.608	-3.508	9.314	-3.524	14.642

Annex A

-4.528	-7.85	-4.715	-2.131	-4.76	3.606	-3.48	9.327	-3.509	14.656
-4.532	-7.833	-4.698	-2.106	-4.755	3.621	-3.496	9.322	-3.502	14.65
-4.533	-7.81	-4.721	-2.106	-4.734	3.645	-3.469	9.349	-3.506	14.648
-4.555	-7.811	-4.742	-2.093	-4.734	3.647	-3.449	9.364		

Table 7. Shear Trial 1 Results

F (Kg)	D (mm)	F (Kg)	D (mm)	F (Kg)	D (mm)	F (Kg)	D (mm)	F (Kg)	D (mm)
-0.067	-18.609	-13.922	-13.687	-34.061	-6.831	-49.058	0.148	-57.912	7.221
-0.062	-18.608	-13.942	-13.672	-34.089	-6.815	-49.068	0.159	-58.043	7.234
-0.076	-18.605	-13.975	-13.661	-34.14	-6.807	-49.056	0.179	-57.798	7.249
-0.069	-18.604	-14.011	-13.64	-34.173	-6.797	-49.097	0.191	-57.899	7.259
-0.081	-18.605	-14.047	-13.629	-34.24	-6.787	-49.126	0.206	-58.002	7.27
-0.076	-18.607	-14.048	-13.618	-34.278	-6.775	-49.129	0.22	-58.061	7.289
-0.079	-18.609	-14.107	-13.61	-34.32	-6.768	-49.168	0.236	-57.895	7.304
-0.076	-18.615	-14.098	-13.6	-34.365	-6.756	-49.111	0.248	-57.856	7.319
-0.094	-18.617	-14.144	-13.588	-34.433	-6.751	-49.148	0.259	-57.98	7.331
-0.092	-18.621	-14.196	-13.581	-34.477	-6.74	-49.204	0.269	-57.98	7.349
-0.081	-18.624	-14.203	-13.574	-34.516	-6.726	-49.188	0.282	-57.812	7.361
-0.086	-18.623	-14.22	-13.561	-34.544	-6.71	-49.234	0.289	-57.928	7.372
-0.088	-18.62	-14.229	-13.55	-34.584	-6.698	-49.213	0.302	-58.058	7.385
-0.061	-18.618	-14.249	-13.537	-34.596	-6.681	-49.271	0.313	-57.934	7.394
-0.069	-18.615	-14.26	-13.524	-34.636	-6.665	-49.274	0.323	-58.008	7.405
-0.069	-18.612	-14.255	-13.51	-34.668	-6.652	-49.268	0.336	-58.072	7.411
-0.07	-18.609	-14.298	-13.495	-34.701	-6.64	-49.26	0.347	-58.115	7.423
-0.066	-18.604	-14.306	-13.476	-34.731	-6.623	-49.225	0.365	-58.084	7.432
-0.072	-18.603	-14.327	-13.465	-34.779	-6.608	-49.276	0.373	-58.1	7.445
-0.068	-18.604	-14.342	-13.45	-34.822	-6.598	-49.283	0.387	-58.239	7.456
-0.08	-18.603	-14.353	-13.432	-34.866	-6.584	-49.273	0.406	-58.323	7.471
-0.071	-18.608	-14.397	-13.422	-34.91	-6.576	-49.296	0.419	-57.962	7.484
-0.08	-18.612	-14.436	-13.41	-34.953	-6.568	-49.3	0.431	-58.155	7.5
-0.08	-18.617	-14.482	-13.397	-34.996	-6.557	-49.296	0.445	-58.278	7.513
-0.088	-18.617	-14.513	-13.387	-35.052	-6.549	-49.337	0.461	-58.014	7.529
-0.091	-18.622	-14.539	-13.378	-35.111	-6.538	-49.347	0.474	-58.042	7.545
-0.098	-18.622	-14.557	-13.372	-35.134	-6.534	-49.354	0.489	-58.114	7.558
-0.088	-18.622	-14.538	-13.362	-35.152	-6.52	-49.349	0.495	-58.184	7.571
-0.072	-18.619	-14.597	-13.351	-35.165	-6.509	-49.354	0.509	-58.041	7.586
-0.075	-18.617	-14.58	-13.338	-35.2	-6.494	-49.335	0.52	-58.113	7.597
-0.067	-18.615	-14.592	-13.329	-35.24	-6.48	-49.368	0.529	-58.268	7.608
-0.066	-18.611	-14.609	-13.318	-35.283	-6.464	-49.348	0.537	-58.202	7.62

Annex A

-0.062	-18.607	-14.62	-13.299	-35.3	-6.449	-49.358	0.553	-58.028	7.626
-0.071	-18.604	-14.646	-13.285	-35.317	-6.436	-49.444	0.563	-58.165	7.64
-0.076	-18.602	-14.662	-13.275	-35.358	-6.42	-49.382	0.579	-58.278	7.65
-0.065	-18.604	-14.701	-13.259	-35.391	-6.407	-49.361	0.591	-58.008	7.664
-0.075	-18.605	-14.726	-13.245	-35.412	-6.392	-49.332	0.602	-58.06	7.673
-0.083	-18.61	-14.743	-13.23	-35.444	-6.375	-49.361	0.622	-58.218	7.688
-0.09	-18.615	-14.766	-13.216	-35.44	-6.361	-49.429	0.632	-58.065	7.702
-0.097	-18.618	-14.796	-13.2	-35.459	-6.348	-49.42	0.648	-58.163	7.713
-0.08	-18.619	-14.8	-13.185	-35.505	-6.335	-49.465	0.664	-58.322	7.729
-0.088	-18.623	-14.824	-13.18	-35.546	-6.324	-49.49	0.682	-58.296	7.747
-0.094	-18.621	-14.864	-13.172	-35.602	-6.315	-49.501	0.691	-58.161	7.757
-0.093	-18.622	-14.891	-13.164	-35.645	-6.306	-49.523	0.703	-58.332	7.77
-0.066	-18.618	-14.928	-13.154	-35.691	-6.296	-49.529	0.719	-58.321	7.79
-0.071	-18.615	-14.939	-13.142	-35.711	-6.285	-49.5	0.729	-58.182	7.8
-0.071	-18.613	-14.962	-13.132	-35.682	-6.275	-49.55	0.738	-58.246	7.811
-0.069	-18.61	-14.972	-13.124	-35.703	-6.267	-49.555	0.748	-58.301	7.821
-0.071	-18.605	-14.961	-13.112	-35.733	-6.258	-49.547	0.758	-58.087	7.834
-0.068	-18.603	-14.988	-13.099	-35.748	-6.246	-49.551	0.769	-58.274	7.846
-0.073	-18.604	-15.015	-13.085	-35.774	-6.235	-49.645	0.776	-58.439	7.852
-0.068	-18.605	-14.994	-13.07	-35.816	-6.222	-49.65	0.788	-58.234	7.865
-0.091	-18.608	-15.013	-13.05	-35.857	-6.208	-49.686	0.803	-58.254	7.874
-0.08	-18.612	-15.026	-13.039	-35.908	-6.189	-49.699	0.817	-58.416	7.887
-0.088	-18.615	-15.054	-13.023	-35.932	-6.178	-49.731	0.833	-58.381	7.898
-0.084	-18.619	-15.069	-13.007	-35.974	-6.166	-49.765	0.844	-58.258	7.909
-0.093	-18.619	-15.115	-12.995	-36	-6.147	-49.789	0.861	-58.426	7.924
-0.096	-18.622	-15.16	-12.98	-36.039	-6.13	-49.747	0.876	-58.455	7.941
-0.079	-18.62	-15.204	-12.97	-36.088	-6.119	-49.739	0.889	-58.217	7.953
-0.069	-18.62	-15.231	-12.962	-36.127	-6.106	-49.8	0.905	-58.428	7.967
-0.075	-18.617	-15.288	-12.95	-36.191	-6.09	-49.781	0.916	-58.55	7.982
-0.067	-18.614	-15.31	-12.943	-36.204	-6.077	-49.775	0.929	-58.247	7.996
-0.069	-18.612	-15.363	-12.934	-36.243	-6.068	-49.788	0.941	-58.338	8.013
-0.065	-18.609	-15.413	-12.926	-36.284	-6.054	-49.787	0.953	-58.518	8.026
-0.059	-18.605	-15.462	-12.913	-36.309	-6.048	-49.799	0.962	-58.225	8.043
-0.064	-18.604	-15.493	-12.904	-36.34	-6.04	-49.847	0.974	-58.325	8.053
-0.078	-18.606	-15.539	-12.891	-36.344	-6.027	-49.798	0.985	-58.496	8.062
-0.072	-18.605	-15.588	-12.879	-36.361	-6.021	-49.917	0.991	-58.248	8.076
-0.083	-18.608	-15.599	-12.862	-36.376	-6.009	-49.9	1.009	-58.359	8.082
-0.088	-18.612	-15.622	-12.848	-36.424	-6	-49.905	1.02	-58.539	8.094
-0.083	-18.616	-15.639	-12.836	-36.461	-5.985	-49.994	1.034	-58.285	8.105
-0.096	-18.618	-15.655	-12.822	-36.48	-5.972	-50.061	1.045	-58.319	8.115
-0.087	-18.621	-15.714	-12.804	-36.525	-5.962	-50.065	1.063	-58.511	8.125

Annex A

-0.092	-18.622	-15.774	-12.791	-36.563	-5.948	-50.089	1.075	-58.282	8.14
-0.085	-18.621	-15.822	-12.78	-36.597	-5.933	-50.142	1.086	-58.393	8.15
-0.081	-18.619	-15.84	-12.768	-36.646	-5.922	-50.133	1.102	-58.532	8.166
-0.072	-18.617	-15.912	-12.759	-36.654	-5.903	-50.123	1.118	-58.41	8.182
-0.073	-18.614	-15.977	-12.75	-36.691	-5.889	-50.141	1.13	-58.334	8.195
-0.066	-18.611	-16.041	-12.741	-36.733	-5.876	-50.116	1.145	-58.502	8.207
-0.072	-18.606	-16.085	-12.731	-36.756	-5.865	-50.151	1.157	-58.402	8.222
-0.069	-18.604	-16.13	-12.722	-36.797	-5.849	-50.245	1.169	-58.36	8.236
-0.067	-18.603	-16.169	-12.711	-36.867	-5.839	-50.254	1.18	-58.453	8.254
-0.071	-18.605	-16.214	-12.702	-36.91	-5.824	-50.23	1.189	-58.483	8.264
-0.085	-18.605	-16.259	-12.689	-36.916	-5.808	-50.251	1.2	-58.321	8.277
-0.078	-18.611	-16.276	-12.673	-36.955	-5.8	-50.292	1.212	-58.525	8.29
-0.083	-18.614	-16.321	-12.659	-37.027	-5.791	-50.255	1.224	-58.641	8.299
-0.091	-18.618	-16.368	-12.642	-37.068	-5.779	-50.188	1.235	-58.415	8.309
-0.102	-18.619	-16.402	-12.631	-37.093	-5.771	-50.346	1.244	-58.606	8.317
-0.087	-18.622	-16.424	-12.611	-37.046	-5.759	-50.328	1.263	-58.742	8.326
-0.086	-18.622	-16.48	-12.597	-37.048	-5.753	-50.36	1.275	-58.407	8.34
-0.093	-18.621	-16.499	-12.587	-37.061	-5.74	-50.413	1.286	-58.609	8.35
-0.07	-18.619	-16.532	-12.572	-37.066	-5.729	-50.461	1.299	-58.679	8.363
-0.069	-18.616	-16.569	-12.562	-37.102	-5.716	-50.473	1.316	-58.474	8.375
-0.077	-18.614	-16.6	-12.554	-37.124	-5.704	-50.5	1.33	-58.67	8.389
-0.065	-18.611	-16.638	-12.544	-37.187	-5.69	-50.526	1.345	-58.635	8.402
-0.068	-18.606	-16.674	-12.534	-37.253	-5.676	-50.552	1.36	-58.526	8.42
-0.072	-18.605	-16.684	-12.526	-37.279	-5.658	-50.486	1.371	-58.693	8.435
-0.07	-18.603	-16.695	-12.516	-37.312	-5.645	-50.521	1.385	-58.631	8.45
-0.073	-18.605	-16.728	-12.51	-37.338	-5.631	-50.51	1.4	-58.454	8.465
-0.085	-18.606	-16.764	-12.497	-37.408	-5.615	-50.538	1.405	-58.732	8.481
-0.071	-18.61	-16.805	-12.486	-37.452	-5.603	-50.608	1.42	-58.712	8.496
-0.086	-18.615	-16.867	-12.471	-37.492	-5.583	-50.683	1.432	-58.59	8.506
-0.084	-18.618	-16.89	-12.458	-37.574	-5.574	-50.737	1.442	-58.793	8.516
-0.089	-18.619	-16.939	-12.443	-37.61	-5.56	-50.786	1.453	-58.783	8.527
-0.074	-18.621	-16.989	-12.428	-37.668	-5.548	-50.79	1.464	-58.558	8.541
-0.079	-18.62	-17.01	-12.412	-37.717	-5.538	-50.711	1.478	-58.741	8.546
-0.073	-18.616	-17.054	-12.401	-37.724	-5.527	-50.798	1.488	-58.764	8.558
-0.066	-18.614	-17.104	-12.383	-37.747	-5.518	-50.773	1.505	-58.818	8.565
-0.067	-18.608	-17.128	-12.37	-37.819	-5.506	-50.812	1.517	-58.852	8.578
-0.065	-18.608	-17.195	-12.358	-37.814	-5.502	-50.897	1.532	-58.921	8.587
-0.07	-18.604	-17.234	-12.348	-37.838	-5.489	-50.983	1.544	-58.894	8.599
-0.067	-18.604	-17.293	-12.341	-37.871	-5.485	-50.999	1.555	-58.805	8.613
-0.078	-18.604	-17.329	-12.331	-37.925	-5.47	-50.939	1.57	-58.915	8.628
-0.085	-18.607	-17.371	-12.325	-37.951	-5.463	-50.956	1.588	-58.705	8.645

Annex A

-0.084	-18.609	-17.391	-12.318	-37.98	-5.449	-50.935	1.597	-58.613	8.66
-0.09	-18.613	-17.44	-12.301	-38.014	-5.437	-50.982	1.61	-58.756	8.676
-0.085	-18.618	-17.466	-12.293	-38.038	-5.42	-50.977	1.626	-58.771	8.689
-0.086	-18.62	-17.5	-12.282	-38.067	-5.404	-50.972	1.632	-58.118	8.71
-0.093	-18.621	-17.516	-12.268	-38.086	-5.395	-51.001	1.645	-58.565	8.722
-0.091	-18.621	-17.557	-12.253	-38.117	-5.376	-51.059	1.654	-58.664	8.734
-0.076	-18.621	-17.583	-12.24	-38.156	-5.36	-50.982	1.665	-58.213	8.748
-0.085	-18.618	-17.635	-12.221	-38.191	-5.345	-50.975	1.677	-58.403	8.758
-0.078	-18.618	-17.663	-12.208	-38.214	-5.333	-51.003	1.691	-58.566	8.766
-0.07	-18.613	-17.719	-12.192	-38.259	-5.319	-51.012	1.705	-58.396	8.776
-0.063	-18.611	-17.752	-12.18	-38.267	-5.306	-51.067	1.718	-58.51	8.788
-0.079	-18.61	-17.779	-12.162	-38.313	-5.294	-51.113	1.732	-58.49	8.795
-0.074	-18.606	-17.813	-12.154	-38.348	-5.28	-51.111	1.744	-58.455	8.808
-0.069	-18.603	-17.85	-12.144	-38.382	-5.271	-51.138	1.758	-58.469	8.816
-0.071	-18.606	-17.858	-12.133	-38.415	-5.255	-51.136	1.776	-58.541	8.833
-0.084	-18.606	-17.856	-12.127	-38.469	-5.253	-51.215	1.79	-58.522	8.845
-0.084	-18.608	-17.848	-12.121	-38.517	-5.24	-51.279	1.806	-58.579	8.859
-0.078	-18.612	-17.881	-12.111	-38.552	-5.23	-51.324	1.817	-58.43	8.873
-0.081	-18.615	-17.931	-12.102	-38.591	-5.22	-51.338	1.828	-58.559	8.892
-0.091	-18.619	-17.961	-12.09	-38.627	-5.217	-51.369	1.838	-58.45	8.906
-0.091	-18.622	-17.988	-12.078	-38.658	-5.202	-51.41	1.851	-58.423	8.919
-0.086	-18.624	-18.015	-12.063	-38.685	-5.189	-51.351	1.862	-58.63	8.932
-0.088	-18.62	-18.035	-12.048	-38.735	-5.176	-51.362	1.873	-58.718	8.95
-0.086	-18.622	-18.079	-12.032	-38.791	-5.16	-51.376	1.88	-58.472	8.959
-0.08	-18.617	-18.094	-12.017	-38.829	-5.151	-51.426	1.89	-58.696	8.972
-0.281	-18.615	-18.139	-12.001	-38.838	-5.134	-51.516	1.902	-58.72	8.983
-0.71	-18.611	-18.175	-11.988	-38.858	-5.119	-51.622	1.917	-58.484	8.994
-1.189	-18.606	-18.21	-11.974	-38.893	-5.103	-51.632	1.93	-58.699	9
-1.641	-18.599	-18.243	-11.964	-38.904	-5.088	-51.617	1.94	-58.775	9.01
-2.025	-18.596	-18.296	-11.951	-38.907	-5.075	-51.658	1.954	-58.506	9.023
-2.368	-18.592	-18.351	-11.939	-38.895	-5.062	-51.691	1.967	-58.699	9.031
-2.373	-18.59	-18.369	-11.928	-38.931	-5.052	-51.794	1.981	-58.881	9.042
-2.217	-18.593	-18.399	-11.921	-38.952	-5.034	-51.817	1.997	-58.729	9.056
-2.073	-18.594	-18.453	-11.907	-39.002	-5.025	-51.804	2.01	-58.62	9.069
-1.969	-18.602	-18.473	-11.901	-39.064	-5.009	-51.856	2.027	-58.792	9.083
-1.94	-18.606	-18.492	-11.892	-39.071	-5.002	-51.927	2.035	-58.665	9.098
-1.969	-18.609	-18.468	-11.88	-39.079	-4.992	-51.954	2.05	-58.57	9.11
-2.178	-18.608	-18.475	-11.867	-39.123	-4.982	-51.871	2.063	-58.788	9.125
-2.65	-18.608	-18.509	-11.854	-39.14	-4.975	-51.913	2.071	-58.773	9.143
-2.922	-18.598	-18.544	-11.842	-39.129	-4.962	-51.962	2.081	-58.453	9.159
-3.19	-18.586	-18.558	-11.825	-39.132	-4.952	-52.011	2.089	-58.763	9.172

Annex A

-3.407	-18.576	-18.613	-11.808	-39.14	-4.94	-52.025	2.102	-58.789	9.187
-3.635	-18.568	-18.63	-11.795	-39.193	-4.927	-52.029	2.114	-58.561	9.202
-3.8	-18.56	-18.663	-11.782	-39.207	-4.916	-52.078	2.126	-58.798	9.207
-3.98	-18.546	-18.698	-11.765	-39.223	-4.901	-52.042	2.14	-58.889	9.22
-4.138	-18.538	-18.752	-11.748	-39.24	-4.885	-52.066	2.154	-58.489	9.234
-4.286	-18.525	-18.782	-11.737	-39.247	-4.871	-51.983	2.171	-58.777	9.24
-4.436	-18.516	-18.842	-11.728	-39.276	-4.861	-51.986	2.186	-58.898	9.251
-4.556	-18.503	-18.871	-11.72	-39.314	-4.842	-52.005	2.197	-58.558	9.264
-4.651	-18.497	-18.916	-11.71	-39.353	-4.828	-52.025	2.214	-58.843	9.271
-4.756	-18.49	-18.961	-11.704	-39.366	-4.809	-52.035	2.231	-59.039	9.28
-4.821	-18.484	-19.014	-11.694	-39.374	-4.799	-52.041	2.243	-58.708	9.301
-4.908	-18.475	-19.043	-11.686	-39.401	-4.788	-52.057	2.26	-58.888	9.31
-4.997	-18.468	-19.082	-11.676	-39.429	-4.773	-51.999	2.271	-59.062	9.322
-5.087	-18.457	-19.153	-11.662	-39.491	-4.758	-52.003	2.284	-58.629	9.342
-5.175	-18.447	-19.184	-11.653	-39.526	-4.748	-52.007	2.294	-58.978	9.353
-5.261	-18.433	-19.196	-11.639	-39.59	-4.733	-52.07	2.3	-59.18	9.365
-5.347	-18.418	-19.221	-11.62	-39.633	-4.724	-52.119	2.313	-58.773	9.379
-5.415	-18.406	-19.249	-11.605	-39.658	-4.715	-52.151	2.324	-58.883	9.394
-5.487	-18.392	-19.263	-11.593	-39.675	-4.702	-52.098	2.333	-59.099	9.409
-5.573	-18.379	-19.284	-11.578	-39.711	-4.7	-52.075	2.341	-58.886	9.423
-5.613	-18.366	-19.342	-11.563	-39.766	-4.691	-52.179	2.358	-58.857	9.434
-5.641	-18.355	-19.376	-11.549	-39.813	-4.679	-52.194	2.368	-59.058	9.445
-5.718	-18.342	-19.417	-11.535	-39.86	-4.671	-52.19	2.385	-58.806	9.457
-5.776	-18.33	-19.469	-11.519	-39.896	-4.656	-52.266	2.398	-58.912	9.466
-5.832	-18.319	-19.537	-11.511	-39.908	-4.645	-52.326	2.414	-59.098	9.477
-5.881	-18.314	-19.551	-11.5	-39.955	-4.631	-52.205	2.428	-58.888	9.49
-5.928	-18.304	-19.596	-11.497	-39.967	-4.62	-52.302	2.441	-58.925	9.497
-5.97	-18.296	-19.649	-11.487	-40.011	-4.602	-52.341	2.454	-59.138	9.508
-6.012	-18.291	-19.689	-11.475	-40.02	-4.59	-52.369	2.47	-58.804	9.526
-6.052	-18.278	-19.719	-11.468	-40.069	-4.574	-52.407	2.482	-58.877	9.535
-6.109	-18.268	-19.737	-11.457	-40.117	-4.555	-52.477	2.493	-59.062	9.55
-6.169	-18.254	-19.79	-11.446	-40.122	-4.54	-52.435	2.508	-58.881	9.564
-6.208	-18.245	-19.827	-11.433	-40.171	-4.528	-52.616	2.516	-58.886	9.578
-6.231	-18.228	-19.856	-11.422	-40.228	-4.517	-52.479	2.53	-59.036	9.595
-6.205	-18.214	-19.874	-11.405	-40.281	-4.503	-52.529	2.536	-58.714	9.612
-6.243	-18.197	-19.921	-11.388	-40.305	-4.493	-52.589	2.547	-58.964	9.621
-6.287	-18.182	-19.922	-11.369	-40.329	-4.48	-52.673	2.559	-58.931	9.639
-6.308	-18.166	-19.947	-11.356	-40.381	-4.47	-52.72	2.572	-58.913	9.653
-6.361	-18.153	-19.95	-11.341	-40.375	-4.461	-52.752	2.586	-59.068	9.662
-6.399	-18.141	-19.974	-11.329	-40.421	-4.452	-52.794	2.596	-58.942	9.676
-6.439	-18.13	-20.009	-11.316	-40.466	-4.439	-52.683	2.612	-58.932	9.685

Annex A

-6.464	-18.124	-20.065	-11.307	-40.465	-4.432	-52.721	2.626	-59.186	9.695
-6.5	-18.113	-20.092	-11.295	-40.504	-4.419	-52.771	2.642	-58.972	9.705
-6.506	-18.104	-20.122	-11.282	-40.579	-4.408	-52.814	2.652	-59.144	9.716
-6.491	-18.093	-20.176	-11.275	-40.593	-4.391	-52.888	2.67	-59.342	9.724
-6.507	-18.086	-20.202	-11.266	-40.619	-4.381	-52.932	2.688	-59.046	9.74
-6.515	-18.077	-20.263	-11.257	-40.652	-4.367	-52.916	2.7	-59.155	9.747
-6.534	-18.065	-20.294	-11.248	-40.675	-4.352	-52.92	2.709	-59.379	9.756
-6.573	-18.049	-20.341	-11.24	-40.706	-4.337	-52.968	2.723	-59.068	9.776
-6.577	-18.036	-20.375	-11.228	-40.729	-4.32	-52.908	2.734	-59.138	9.787
-6.604	-18.022	-20.436	-11.217	-40.762	-4.311	-52.905	2.738	-59.324	9.803
-6.628	-18.003	-20.469	-11.201	-40.77	-4.298	-52.958	2.753	-59.227	9.816
-6.641	-17.989	-20.504	-11.188	-40.791	-4.282	-52.991	2.761	-59.123	9.831
-6.675	-17.976	-20.533	-11.173	-40.802	-4.269	-52.98	2.771	-59.384	9.844
-6.715	-17.964	-20.567	-11.156	-40.844	-4.261	-52.995	2.781	-59.204	9.861
-6.756	-17.95	-20.605	-11.142	-40.9	-4.244	-53.058	2.796	-59.179	9.871
-6.807	-17.941	-20.675	-11.125	-40.917	-4.233	-53.082	2.808	-59.375	9.887
-6.798	-17.927	-20.704	-11.111	-40.958	-4.224	-53.07	2.825	-59.199	9.897
-6.567	-17.921	-20.745	-11.098	-40.99	-4.21	-53.068	2.837	-59.375	9.906
-6.564	-17.909	-20.781	-11.085	-41.013	-4.2	-53.095	2.856	-59.566	9.918
-6.585	-17.901	-20.86	-11.069	-41.04	-4.191	-53.147	2.87	-59.156	9.931
-6.592	-17.893	-20.884	-11.062	-41.076	-4.178	-53.208	2.885	-59.259	9.939
-6.603	-17.882	-20.919	-11.05	-41.104	-4.169	-53.237	2.897	-59.377	9.953
-6.613	-17.868	-20.96	-11.041	-41.136	-4.157	-53.257	2.911	-59.242	9.96
-6.631	-17.855	-21.01	-11.033	-41.165	-4.145	-53.297	2.926	-59.462	9.969
-6.633	-17.843	-21.038	-11.026	-41.208	-4.133	-53.29	2.937	-59.553	9.989
-6.639	-17.825	-21.078	-11.018	-41.238	-4.122	-53.321	2.949	-59.326	10
-6.622	-17.811	-21.13	-11.004	-41.257	-4.103	-53.309	2.959	-59.576	10.011
-6.653	-17.795	-21.186	-10.995	-41.27	-4.095	-53.34	2.969	-59.604	10.028
-6.692	-17.782	-21.201	-10.982	-41.299	-4.078	-53.385	2.974	-59.203	10.044
-6.712	-17.765	-21.259	-10.971	-41.342	-4.065	-53.443	2.984	-59.385	10.058
-6.734	-17.753	-21.272	-10.954	-41.386	-4.051	-53.42	2.996	-59.416	10.073
-6.763	-17.74	-21.276	-10.939	-41.408	-4.034	-53.404	3.013	-59.36	10.089
-6.727	-17.729	-21.27	-10.928	-41.435	-4.018	-53.435	3.024	-59.518	10.1
-6.727	-17.719	-21.289	-10.908	-41.457	-4.005	-53.425	3.037	-59.435	10.115
-6.742	-17.711	-21.338	-10.891	-41.515	-3.991	-53.344	3.053	-59.365	10.125
-6.781	-17.703	-21.386	-10.882	-41.554	-3.979	-53.395	3.069	-59.604	10.135
-6.842	-17.695	-21.425	-10.866	-41.599	-3.97	-53.412	3.083	-59.529	10.147
-6.84	-17.683	-21.459	-10.854	-41.628	-3.959	-53.418	3.095	-59.341	10.155
-6.85	-17.671	-21.466	-10.84	-41.647	-3.946	-53.478	3.113	-59.603	10.164
-6.863	-17.665	-21.481	-10.829	-41.686	-3.937	-53.544	3.12	-59.626	10.176
-6.887	-17.651	-21.517	-10.822	-41.713	-3.924	-53.423	3.136	-59.38	10.186

Annex A

-6.916	-17.632	-21.572	-10.812	-41.755	-3.916	-53.452	3.147	-59.614	10.198
-6.926	-17.619	-21.613	-10.802	-41.807	-3.909	-53.505	3.157	-59.401	10.214
-6.932	-17.604	-21.682	-10.796	-41.84	-3.893	-53.552	3.17	-59.58	10.229
-6.937	-17.587	-21.723	-10.789	-41.903	-3.883	-53.591	3.179	-59.734	10.239
-6.958	-17.574	-21.744	-10.777	-41.957	-3.87	-53.544	3.188	-59.44	10.256
-6.986	-17.562	-21.792	-10.764	-41.988	-3.857	-53.617	3.197	-59.515	10.268
-7.018	-17.55	-21.858	-10.753	-42.024	-3.842	-53.508	3.211	-59.742	10.281
-7.061	-17.536	-21.899	-10.741	-42.064	-3.829	-53.528	3.224	-59.366	10.299
-7.095	-17.528	-21.959	-10.725	-42.1	-3.818	-53.447	3.231	-59.517	10.311
-7.155	-17.517	-22.003	-10.71	-42.137	-3.803	-53.522	3.246	-59.734	10.326
-7.182	-17.509	-22.042	-10.693	-42.179	-3.786	-53.551	3.264	-59.516	10.338
-7.205	-17.502	-22.087	-10.678	-42.224	-3.777	-53.586	3.277	-59.526	10.347
-7.231	-17.491	-22.102	-10.666	-42.265	-3.761	-53.668	3.291	-59.73	10.359
-7.255	-17.484	-22.174	-10.646	-42.284	-3.747	-53.552	3.309	-59.435	10.372
-7.267	-17.473	-22.245	-10.637	-42.306	-3.736	-53.546	3.321	-59.485	10.383
-7.271	-17.458	-22.302	-10.626	-42.363	-3.723	-53.561	3.338	-59.613	10.395
-7.271	-17.444	-22.369	-10.612	-42.37	-3.711	-53.601	3.352	-59.684	10.402
-7.275	-17.429	-22.414	-10.599	-42.385	-3.701	-53.649	3.366	-59.296	10.416
-7.25	-17.413	-22.444	-10.592	-42.416	-3.687	-53.658	3.377	-59.511	10.432
-7.278	-17.396	-22.456	-10.584	-42.427	-3.679	-53.589	3.392	-59.592	10.443
-7.274	-17.382	-22.512	-10.571	-42.459	-3.669	-53.632	3.397	-59.292	10.455
-7.3	-17.369	-22.561	-10.565	-42.485	-3.66	-53.733	3.408	-59.483	10.47
-7.341	-17.355	-22.61	-10.56	-42.505	-3.646	-53.821	3.417	-59.349	10.488
-7.379	-17.342	-22.665	-10.551	-42.529	-3.634	-53.849	3.425	-59.208	10.499
-7.387	-17.332	-22.694	-10.538	-42.538	-3.617	-53.766	3.437	-59.44	10.511
-7.415	-17.319	-22.721	-10.524	-42.57	-3.605	-53.818	3.45	-59.363	10.528
-7.42	-17.313	-22.739	-10.512	-42.55	-3.593	-53.837	3.463	-59.08	10.54
-7.441	-17.304	-22.762	-10.5	-42.559	-3.58	-53.893	3.475	-59.285	10.553
-7.438	-17.292	-22.819	-10.483	-42.584	-3.567	-53.921	3.491	-59.387	10.563
-7.471	-17.283	-22.856	-10.467	-42.595	-3.55	-53.788	3.505	-58.956	10.574
-7.471	-17.279	-22.882	-10.451	-42.633	-3.536	-53.839	3.518	-59.239	10.59
-7.481	-17.262	-22.939	-10.438	-42.652	-3.523	-53.905	3.534	-59.41	10.597
-7.484	-17.248	-22.984	-10.423	-42.662	-3.512	-53.989	3.549	-58.899	10.611
-7.485	-17.234	-22.998	-10.41	-42.689	-3.498	-54.063	3.565	-59.278	10.62
-7.471	-17.215	-23.062	-10.4	-42.692	-3.486	-54.086	3.582	-59.46	10.63
-7.46	-17.207	-23.101	-10.388	-42.729	-3.475	-53.981	3.589	-58.855	10.646
-7.473	-17.189	-23.147	-10.377	-42.791	-3.464	-54.064	3.602	-59.331	10.651
-7.486	-17.177	-23.226	-10.367	-42.802	-3.451	-54.107	3.614	-59.461	10.667
-7.488	-17.162	-23.252	-10.354	-42.803	-3.439	-54.171	3.622	-59.037	10.686
-7.482	-17.151	-23.275	-10.347	-42.818	-3.431	-54.212	3.629	-59.302	10.689
-7.492	-17.134	-23.312	-10.337	-42.826	-3.42	-54.197	3.637	-59.368	10.706

Annex A

-7.497	-17.127	-23.361	-10.327	-42.848	-3.412	-54.114	3.651	-59.185	10.724
-7.506	-17.118	-23.41	-10.317	-42.863	-3.396	-54.144	3.659	-59.096	10.736
-7.519	-17.109	-23.44	-10.305	-42.879	-3.386	-54.23	3.671	-59.283	10.749
-7.519	-17.098	-23.454	-10.292	-42.907	-3.372	-54.273	3.683	-59.182	10.764
-7.512	-17.09	-23.478	-10.276	-42.942	-3.357	-54.24	3.702	-59.236	10.776
-7.503	-17.081	-23.489	-10.264	-42.971	-3.341	-54.214	3.716	-59.331	10.789
-7.497	-17.071	-23.513	-10.248	-42.968	-3.333	-54.242	3.728	-59.262	10.806
-7.471	-17.057	-23.566	-10.233	-43.02	-3.314	-54.305	3.742	-59.229	10.818
-7.468	-17.042	-23.619	-10.215	-43.039	-3.304	-54.346	3.759	-59.259	10.826
-7.471	-17.027	-23.689	-10.206	-43.06	-3.289	-54.345	3.778	-59.074	10.84
-7.461	-17.012	-23.759	-10.188	-43.086	-3.273	-54.361	3.791	-58.992	10.849
-7.447	-16.996	-23.8	-10.176	-43.116	-3.26	-54.311	3.803	-59.222	10.86
-7.443	-16.984	-23.856	-10.156	-43.152	-3.247	-54.263	3.821	-59.049	10.876
-7.428	-16.97	-23.88	-10.152	-43.174	-3.232	-54.368	3.83	-59.067	10.886
-7.435	-16.955	-23.936	-10.145	-43.225	-3.223	-54.297	3.835	-59.27	10.895
-7.478	-16.94	-23.972	-10.136	-43.244	-3.208	-54.355	3.844	-58.806	10.915
-7.514	-16.928	-24.045	-10.123	-43.301	-3.199	-54.454	3.855	-58.939	10.923
-7.504	-16.92	-24.093	-10.119	-43.387	-3.189	-54.505	3.864	-59.147	10.936
-7.535	-16.908	-24.145	-10.108	-43.411	-3.178	-54.434	3.873	-58.848	10.946
-7.547	-16.901	-24.151	-10.098	-43.464	-3.169	-54.535	3.889	-59.006	10.959
-7.589	-16.89	-24.219	-10.087	-43.495	-3.153	-54.534	3.9	-59.164	10.974
-7.609	-16.884	-24.264	-10.076	-43.508	-3.147	-54.526	3.915	-58.718	10.991
-7.676	-16.876	-24.299	-10.063	-43.562	-3.137	-54.558	3.927	-58.955	10.999
-7.705	-16.862	-24.325	-10.047	-43.578	-3.123	-54.577	3.941	-58.981	11.016
-7.71	-16.849	-24.342	-10.031	-43.614	-3.113	-54.563	3.957	-58.998	11.027
-7.711	-16.834	-24.33	-10.013	-43.661	-3.1	-54.583	3.976	-59.121	11.037
-7.745	-16.822	-24.371	-9.998	-43.676	-3.084	-54.647	3.991	-59.028	11.053
-7.744	-16.807	-24.362	-9.983	-43.696	-3.074	-54.756	4.004	-58.985	11.064
-7.758	-16.79	-24.43	-9.97	-43.728	-3.059	-54.731	4.016	-59.084	11.075
-7.766	-16.779	-24.473	-9.958	-43.747	-3.046	-54.75	4.027	-58.981	11.087
-7.805	-16.766	-24.513	-9.945	-43.773	-3.031	-54.773	4.035	-58.963	11.097
-7.845	-16.75	-24.566	-9.932	-43.816	-3.018	-54.815	4.047	-59.132	11.111
-7.849	-16.738	-24.625	-9.921	-43.86	-3.003	-54.799	4.059	-59.019	11.122
-7.85	-16.729	-24.631	-9.915	-43.886	-2.987	-54.719	4.066	-59.008	11.135
-7.912	-16.719	-24.684	-9.902	-43.91	-2.979	-54.709	4.075	-59.147	11.145
-7.955	-16.708	-24.721	-9.896	-43.947	-2.964	-54.696	4.09	-59.031	11.163
-8.007	-16.699	-24.79	-9.884	-43.982	-2.954	-54.749	4.1	-58.861	11.174
-8.017	-16.692	-24.848	-9.872	-44.003	-2.943	-54.79	4.118	-59.109	11.186
-8.057	-16.684	-24.88	-9.864	-44.022	-2.933	-54.715	4.13	-59.111	11.197
-8.077	-16.672	-24.894	-9.852	-44.033	-2.923	-54.783	4.15	-58.97	11.214
-8.12	-16.661	-24.919	-9.84	-44.009	-2.911	-54.804	4.163	-59.08	11.23

Annex A

-8.175	-16.648	-24.986	-9.826	-44.009	-2.903	-54.765	4.181	-59.152	11.242
-8.228	-16.634	-24.995	-9.813	-44.027	-2.892	-54.785	4.199	-58.93	11.253
-8.254	-16.615	-25.031	-9.794	-44.035	-2.877	-54.824	4.212	-58.903	11.267
-8.284	-16.605	-25.052	-9.783	-44.059	-2.861	-54.768	4.221	-58.945	11.279
-8.303	-16.588	-25.11	-9.769	-44.076	-2.85	-54.741	4.235	-58.754	11.292
-8.343	-16.568	-25.155	-9.758	-44.084	-2.838	-54.755	4.243	-58.838	11.302
-8.373	-16.557	-25.196	-9.743	-44.089	-2.826	-54.873	4.253	-58.934	11.314
-8.399	-16.545	-25.282	-9.73	-44.092	-2.811	-54.867	4.26	-58.852	11.323
-8.444	-16.533	-25.316	-9.719	-44.094	-2.794	-54.863	4.269	-58.628	11.334
-8.471	-16.524	-25.378	-9.706	-44.101	-2.782	-54.889	4.281	-58.757	11.343
-8.505	-16.511	-25.422	-9.695	-44.117	-2.764	-54.824	4.292	-58.605	11.361
-8.54	-16.496	-25.496	-9.682	-44.144	-2.752	-54.824	4.305	-58.533	11.371
-8.553	-16.492	-25.536	-9.674	-44.149	-2.739	-54.952	4.316	-58.736	11.382
-8.58	-16.483	-25.581	-9.666	-44.152	-2.729	-54.977	4.333	-58.753	11.396
-8.604	-16.471	-25.635	-9.656	-44.163	-2.714	-55.03	4.345	-58.423	11.413
-8.608	-16.464	-25.7	-9.646	-44.194	-2.705	-54.94	4.36	-58.705	11.424
-8.611	-16.452	-25.757	-9.634	-44.239	-2.694	-54.914	4.379	-58.838	11.438
-8.649	-16.436	-25.804	-9.625	-44.269	-2.683	-54.961	4.396	-58.467	11.452
-8.684	-16.424	-25.876	-9.611	-44.308	-2.671	-55.024	4.408	-58.582	11.465
-8.704	-16.411	-25.919	-9.598	-44.32	-2.662	-55.104	4.421	-58.647	11.478
-8.751	-16.402	-25.934	-9.58	-44.348	-2.655	-55.225	4.434	-58.524	11.496
-8.757	-16.384	-25.945	-9.564	-44.389	-2.642	-55.114	4.441	-58.442	11.509
-8.785	-16.369	-26.018	-9.549	-44.407	-2.629	-55.081	4.451	-58.499	11.52
-8.798	-16.352	-26.014	-9.536	-44.446	-2.616	-55.134	4.461	-58.543	11.53
-8.795	-16.341	-26.043	-9.519	-44.481	-2.606	-55.23	4.47	-58.357	11.539
-8.831	-16.323	-26.063	-9.506	-44.5	-2.593	-55.293	4.484	-58.473	11.549
-8.802	-16.311	-26.091	-9.49	-44.511	-2.577	-55.211	4.495	-58.555	11.562
-8.786	-16.299	-26.138	-9.479	-44.544	-2.561	-55.204	4.506	-58.52	11.575
-8.82	-16.286	-26.136	-9.468	-44.558	-2.549	-55.19	4.523	-58.54	11.584
-8.848	-16.275	-26.197	-9.462	-44.6	-2.534	-55.239	4.535	-58.479	11.597
-8.853	-16.263	-26.255	-9.449	-44.661	-2.518	-55.306	4.551	-58.546	11.612
-8.885	-16.255	-26.287	-9.441	-44.722	-2.507	-55.267	4.567	-58.4	11.624
-8.926	-16.245	-26.321	-9.434	-44.738	-2.49	-55.296	4.582	-58.373	11.636
-8.948	-16.237	-26.367	-9.421	-44.771	-2.48	-55.343	4.593	-58.487	11.652
-8.986	-16.229	-26.39	-9.412	-44.781	-2.46	-55.362	4.608	-58.532	11.667
-9.031	-16.218	-26.439	-9.395	-44.796	-2.453	-55.441	4.622	-58.312	11.682
-9.067	-16.209	-26.481	-9.394	-44.835	-2.439	-55.279	4.635	-58.408	11.695
-9.097	-16.194	-26.548	-9.377	-44.897	-2.432	-55.366	4.645	-58.187	11.703
-9.13	-16.18	-26.607	-9.362	-44.951	-2.422	-55.441	4.651	-57.896	11.709
-9.129	-16.167	-26.609	-9.351	-45.006	-2.409	-55.49	4.666	-57.719	11.706
-9.125	-16.149	-26.661	-9.335	-45.054	-2.399	-55.534	4.674	-57.574	11.704

Annex A

-9.138	-16.136	-26.696	-9.32	-45.07	-2.393	-55.479	4.683	-57.46	11.707
-9.162	-16.12	-26.741	-9.304	-45.074	-2.375	-55.379	4.691	-57.376	11.709
-9.191	-16.104	-26.798	-9.292	-45.105	-2.368	-55.429	4.705	-57.284	11.708
-9.233	-16.091	-26.833	-9.275	-45.132	-2.358	-55.535	4.719	-57.219	11.706
-9.27	-16.076	-26.894	-9.263	-45.167	-2.344	-55.599	4.733	-57.163	11.703
-9.276	-16.063	-26.948	-9.25	-45.208	-2.329	-55.42	4.75	-57.104	11.703
-9.318	-16.054	-27.005	-9.241	-45.23	-2.316	-55.582	4.764	-57.053	11.7
-9.337	-16.043	-27.053	-9.232	-45.251	-2.299	-55.568	4.777	-57.006	11.701
-9.35	-16.036	-27.095	-9.221	-45.27	-2.287	-55.647	4.792	-56.939	11.699
-9.374	-16.023	-27.14	-9.211	-45.299	-2.269	-55.694	4.808	-56.901	11.703
-9.402	-16.021	-27.205	-9.202	-45.348	-2.255	-55.53	4.821	-56.852	11.707
-9.426	-16.01	-27.256	-9.192	-45.395	-2.24	-55.657	4.832	-56.808	11.71
-9.42	-15.998	-27.303	-9.184	-45.434	-2.23	-55.684	4.842	-56.774	11.711
-9.417	-15.988	-27.354	-9.171	-45.465	-2.21	-55.745	4.853	-56.732	11.713
-9.422	-15.976	-27.369	-9.157	-45.505	-2.205	-55.804	4.862	-56.708	11.709
-9.424	-15.959	-27.397	-9.148	-45.566	-2.195	-55.568	4.871	-56.692	11.707
-9.418	-15.942	-27.429	-9.132	-45.613	-2.186	-55.742	4.88	-56.67	11.71
-9.426	-15.923	-27.475	-9.118	-45.662	-2.174	-55.83	4.893	-56.631	11.711
-9.432	-15.912	-27.544	-9.102	-45.703	-2.167	-55.84	4.908	-56.619	11.708
-9.47	-15.898	-27.563	-9.086	-45.743	-2.158	-55.912	4.922	-56.583	11.709
-9.481	-15.885	-27.583	-9.07	-45.762	-2.147	-55.77	4.937	-56.563	11.71
-9.485	-15.873	-27.611	-9.055	-45.766	-2.134	-55.881	4.951	-56.539	11.71
-9.489	-15.859	-27.642	-9.04	-45.781	-2.121	-55.973	4.965	-56.511	11.711
-9.509	-15.852	-27.68	-9.03	-45.813	-2.108	-55.897	4.982	-56.488	11.709
-9.544	-15.838	-27.732	-9.019	-45.849	-2.094	-55.889	4.992	-56.471	11.71
-9.555	-15.829	-27.764	-9.006	-45.877	-2.08	-55.981	5.008	-56.437	11.711
-9.564	-15.82	-27.79	-8.999	-45.894	-2.064	-56.043	5.02	-56.412	11.711
-9.561	-15.815	-27.834	-8.993	-45.926	-2.051	-56.052	5.031	-56.388	11.709
-9.603	-15.801	-27.865	-8.982	-45.93	-2.035	-56.034	5.039	-56.363	11.709
-9.648	-15.789	-27.891	-8.975	-45.946	-2.017	-55.938	5.054	-56.363	11.712
-9.652	-15.781	-27.942	-8.966	-45.979	-2.005	-56.03	5.062	-56.341	11.711
-9.693	-15.762	-27.996	-8.951	-45.983	-1.989	-56.116	5.071	-56.339	11.712
-9.696	-15.747	-28.041	-8.94	-46.01	-1.981	-55.946	5.082	-56.308	11.714
-9.683	-15.729	-28.075	-8.927	-46.036	-1.965	-56.048	5.095	-56.309	11.714
-9.723	-15.716	-28.101	-8.912	-46.049	-1.956	-56.118	5.105	-56.295	11.712
-9.74	-15.701	-28.15	-8.896	-46.057	-1.945	-56.193	5.119	-56.292	11.71
-9.779	-15.686	-28.182	-8.883	-46.08	-1.941	-55.99	5.134	-56.277	11.708
-9.809	-15.67	-28.175	-8.867	-46.114	-1.93	-55.946	5.151	-56.261	11.706
-9.832	-15.66	-28.246	-8.853	-46.136	-1.92	-55.966	5.166	-56.25	11.705
-9.87	-15.649	-28.295	-8.84	-46.141	-1.911	-56.007	5.178	-56.24	11.705
-9.876	-15.635	-28.324	-8.822	-46.173	-1.901	-55.959	5.191	-56.22	11.703

Annex A

-9.919	-15.635	-28.343	-8.812	-46.161	-1.884	-55.927	5.207	-56.207	11.705
-9.946	-15.627	-28.39	-8.8	-46.158	-1.873	-55.978	5.221	-56.193	11.707
-9.966	-15.62	-28.441	-8.791	-46.183	-1.864	-56.072	5.231	-56.184	11.709
-10.006	-15.61	-28.488	-8.781	-46.223	-1.845	-56.065	5.248	-56.157	11.714
-10.02	-15.599	-28.525	-8.771	-46.251	-1.833	-55.936	5.258	-56.153	11.719
-10.031	-15.587	-28.562	-8.764	-46.255	-1.817	-56.043	5.266	-56.138	11.719
-10.054	-15.575	-28.612	-8.748	-46.285	-1.8	-56.101	5.276	-56.135	11.718
-10.084	-15.557	-28.659	-8.743	-46.327	-1.784	-56.155	5.287	-56.134	11.719
-10.115	-15.544	-28.685	-8.728	-46.334	-1.77	-56.057	5.3	-56.125	11.719
-10.147	-15.529	-28.72	-8.719	-46.363	-1.754	-55.97	5.311	-56.126	11.717
-10.188	-15.514	-28.753	-8.703	-46.379	-1.741	-56.034	5.326	-56.105	11.714
-10.218	-15.498	-28.787	-8.69	-46.419	-1.731	-56.066	5.338	-56.097	11.71
-10.286	-15.486	-28.827	-8.674	-46.412	-1.716	-56	5.354	-56.093	11.709
-10.311	-15.474	-28.865	-8.66	-46.431	-1.707	-55.992	5.369	-56.065	11.707
-10.344	-15.462	-28.915	-8.647	-46.462	-1.695	-55.992	5.382	-56.052	11.706
-10.387	-15.451	-28.957	-8.632	-46.474	-1.687	-56.094	5.394	-56.048	11.708
-10.418	-15.442	-29.015	-8.618	-46.486	-1.674	-56.074	5.415	-56.032	11.711
-10.463	-15.435	-29.048	-8.604	-46.497	-1.668	-55.961	5.423	-56.029	11.712
-10.503	-15.425	-29.118	-8.593	-46.539	-1.659	-56.069	5.434	-56.019	11.711
-10.519	-15.415	-29.218	-8.579	-46.586	-1.645	-56.187	5.446	-56.013	11.715
-10.53	-15.406	-29.249	-8.57	-46.607	-1.635	-56.051	5.463	-56.003	11.715
-10.563	-15.396	-29.332	-8.559	-46.62	-1.62	-56.005	5.469	-56.005	11.712
-10.575	-15.381	-29.358	-8.55	-46.651	-1.611	-56.106	5.479	-55.992	11.712
-10.659	-15.363	-29.428	-8.541	-46.681	-1.594	-56.237	5.489	-55.982	11.713
-10.675	-15.353	-29.508	-8.53	-46.707	-1.58	-55.995	5.502	-55.968	11.711
-10.7	-15.339	-29.551	-8.521	-46.729	-1.567	-56.083	5.511	-55.961	11.712
-10.743	-15.322	-29.611	-8.513	-46.774	-1.553	-56.193	5.528	-55.936	11.714
-10.758	-15.302	-29.657	-8.5	-46.785	-1.539	-56.17	5.538	-55.918	11.716
-10.776	-15.293	-29.707	-8.484	-46.815	-1.523	-56.128	5.554	-55.918	11.719
-10.804	-15.28	-29.748	-8.476	-46.809	-1.509	-56.144	5.568	-55.913	11.721
-10.841	-15.268	-29.79	-8.459	-46.807	-1.494	-56.207	5.58	-55.91	11.716
-10.88	-15.254	-29.854	-8.444	-46.803	-1.48	-56.202	5.595	-55.894	11.715
-10.913	-15.247	-29.901	-8.431	-46.78	-1.467	-56.06	5.609	-55.899	11.714
-10.952	-15.238	-29.916	-8.415	-46.785	-1.458	-56.15	5.624	-55.893	11.71
-11.011	-15.228	-29.945	-8.403	-46.761	-1.45	-56.275	5.634	-55.883	11.707
-11.026	-15.224	-29.917	-8.388	-46.778	-1.439	-56.231	5.652	-55.885	11.707
-11.042	-15.216	-29.965	-8.37	-46.782	-1.426	-56.106	5.663	-55.881	11.707
-11.042	-15.204	-30.005	-8.361	-46.768	-1.417	-56.172	5.67	-55.861	11.706
-11.027	-15.192	-30.035	-8.348	-46.763	-1.408	-56.285	5.68	-55.839	11.708
-11.042	-15.178	-30.044	-8.335	-46.757	-1.398	-56.157	5.696	-55.833	11.709
-11.052	-15.165	-30.033	-8.328	-46.78	-1.387	-56.189	5.704	-55.827	11.711

Annex A

-11.068	-15.147	-30.052	-8.318	-46.836	-1.372	-56.241	5.714	-55.805	11.714
-11.118	-15.132	-30.048	-8.307	-46.826	-1.36	-56.315	5.727	-55.805	11.717
-11.162	-15.116	-30.08	-8.296	-46.864	-1.343	-56.15	5.745	-55.799	11.718
-11.204	-15.102	-30.125	-8.288	-46.906	-1.332	-56.089	5.757	-55.786	11.723
-11.268	-15.088	-30.173	-8.275	-46.939	-1.318	-56.207	5.768	-55.796	11.72
-11.288	-15.075	-30.235	-8.262	-46.99	-1.302	-56.279	5.784	-55.786	11.719
-11.351	-15.066	-30.258	-8.248	-47.018	-1.284	-56.198	5.8	-55.783	11.72
-11.392	-15.054	-30.281	-8.231	-47.016	-1.268	-56.18	5.815	-55.77	11.717
-11.443	-15.042	-30.301	-8.222	-47.006	-1.256	-56.148	5.829	-55.773	11.713
-11.507	-15.036	-30.312	-8.208	-47.021	-1.24	-56.191	5.842	-55.783	11.712
-11.552	-15.026	-30.346	-8.194	-47.056	-1.225	-56.247	5.853	-55.766	11.71
-11.609	-15.019	-30.36	-8.177	-47.042	-1.213	-56.088	5.864	-55.763	11.708
-11.64	-15.009	-30.422	-8.165	-47.04	-1.206	-56.127	5.874	-55.76	11.707
-11.663	-14.996	-30.438	-8.151	-47.069	-1.193	-56.283	5.882	-55.735	11.708
-11.717	-14.983	-30.467	-8.136	-47.072	-1.183	-56.377	5.894	-55.726	11.707
-11.758	-14.971	-30.482	-8.125	-47.06	-1.177	-56.186	5.903	-55.707	11.71
-11.769	-14.957	-30.516	-8.117	-46.985	-1.168	-56.252	5.913	-55.701	11.713
-11.797	-14.941	-30.545	-8.106	-47.004	-1.159	-56.374	5.925	-55.706	11.712
-11.798	-14.927	-30.596	-8.096	-47.037	-1.147	-56.348	5.941	-55.705	11.717
-11.763	-14.91	-30.657	-8.088	-47.063	-1.136	-56.197	5.95	-55.687	11.72
-11.72	-14.891	-30.727	-8.077	-47.055	-1.123	-56.363	5.965	-55.695	11.719
-11.754	-14.881	-30.75	-8.066	-47.072	-1.11	-56.49	5.98	-55.686	11.72
-11.743	-14.867	-30.757	-8.057	-47.087	-1.092	-56.513	5.994	-55.681	11.723
-11.742	-14.856	-30.788	-8.042	-47.079	-1.079	-56.349	6.013	-55.674	11.722
-11.735	-14.847	-30.824	-8.032	-47.043	-1.064	-56.502	6.021	-55.671	11.718
-11.73	-14.837	-30.843	-8.017	-47.067	-1.049	-56.604	6.034	-55.654	11.716
-11.563	-14.828	-30.853	-8.002	-47.134	-1.033	-56.613	6.052	-55.657	11.713
-11.6	-14.818	-30.853	-7.984	-47.181	-1.021	-56.7	6.064	-55.652	11.712
-11.645	-14.81	-30.838	-7.972	-47.21	-1.005	-56.495	6.073	-55.638	11.71
-11.665	-14.8	-30.859	-7.954	-47.208	-0.988	-56.678	6.085	-55.656	11.707
-11.679	-14.788	-30.874	-7.943	-47.201	-0.976	-56.714	6.094	-55.638	11.707
-11.752	-14.774	-30.912	-7.925	-47.253	-0.964	-56.588	6.109	-55.63	11.708
-11.803	-14.76	-30.978	-7.911	-47.228	-0.953	-56.622	6.118	-55.621	11.709
-11.822	-14.744	-31	-7.898	-47.238	-0.942	-56.568	6.132	-55.612	11.71
-11.83	-14.728	-31.047	-7.887	-47.273	-0.931	-56.747	6.142	-55.617	11.714
-11.842	-14.713	-31.067	-7.877	-47.372	-0.922	-56.829	6.156	-55.605	11.716
-11.871	-14.699	-31.075	-7.868	-47.396	-0.916	-56.657	6.169	-55.603	11.719
-11.905	-14.688	-31.091	-7.861	-47.342	-0.902	-56.885	6.177	-55.586	11.721
-11.961	-14.672	-31.119	-7.851	-47.385	-0.89	-56.741	6.193	-55.593	11.724
-12.008	-14.661	-31.161	-7.838	-47.395	-0.881	-56.84	6.209	-55.58	11.721
-12.06	-14.648	-31.212	-7.831	-47.404	-0.87	-56.906	6.222	-55.579	11.721

Annex A

-12.076	-14.639	-31.262	-7.818	-47.411	-0.854	-56.756	6.237	-55.568	11.719
-12.103	-14.629	-31.318	-7.805	-47.462	-0.84	-56.779	6.247	-55.569	11.717
-12.145	-14.621	-31.352	-7.797	-47.513	-0.826	-56.885	6.256	-55.562	11.715
-12.205	-14.612	-31.39	-7.778	-47.521	-0.813	-56.861	6.274	-55.562	11.711
-12.269	-14.602	-31.436	-7.766	-47.545	-0.793	-56.745	6.284	-55.552	11.708
-12.342	-14.591	-31.487	-7.75	-47.544	-0.781	-56.73	6.296	-55.566	11.709
-12.387	-14.58	-31.536	-7.738	-47.561	-0.767	-56.851	6.303	-55.557	11.708
-12.487	-14.57	-31.586	-7.723	-47.598	-0.753	-56.782	6.316	-55.549	11.708
-12.534	-14.553	-31.64	-7.707	-47.616	-0.739	-56.759	6.328	-55.542	11.71
-12.565	-14.541	-31.656	-7.691	-47.613	-0.726	-56.866	6.338	-55.532	11.713
-12.61	-14.524	-31.705	-7.68	-47.592	-0.712	-56.967	6.353	-55.528	11.712
-12.676	-14.514	-31.772	-7.669	-47.587	-0.703	-56.78	6.363	-55.522	11.714
-12.755	-14.496	-31.815	-7.659	-47.546	-0.689	-56.929	6.376	-55.516	11.717
-12.821	-14.483	-31.871	-7.648	-47.604	-0.68	-57.046	6.391	-55.51	11.719
-12.877	-14.472	-31.887	-7.64	-47.647	-0.67	-56.704	6.407	-55.51	11.722
-12.912	-14.456	-31.914	-7.628	-47.69	-0.661	-56.798	6.418	-55.497	11.72
-12.939	-14.445	-31.944	-7.623	-47.681	-0.65	-56.967	6.434	-55.495	11.719
-12.988	-14.439	-31.995	-7.611	-47.668	-0.64	-56.722	6.448	-55.472	11.719
-13.021	-14.431	-32.014	-7.6	-47.694	-0.628	-56.853	6.459	-55.474	11.719
-13.014	-14.425	-32.068	-7.588	-47.708	-0.615	-57.031	6.472	-55.479	11.717
-12.949	-14.412	-32.103	-7.576	-47.749	-0.606	-56.914	6.488	-55.495	11.715
-12.928	-14.402	-32.128	-7.558	-47.778	-0.586	-56.829	6.503	-55.475	11.716
-12.97	-14.392	-32.144	-7.543	-47.773	-0.571	-56.992	6.508	-55.475	11.715
-12.991	-14.376	-32.181	-7.529	-47.78	-0.557	-56.973	6.523	-55.463	11.716
-13.051	-14.368	-32.214	-7.516	-47.857	-0.541	-56.821	6.533	-55.464	11.716
-13.104	-14.35	-32.255	-7.499	-47.871	-0.528	-56.914	6.545	-55.465	11.717
-13.102	-14.337	-32.286	-7.482	-47.855	-0.509	-57.006	6.557	-55.469	11.717
-13.103	-14.317	-32.327	-7.465	-47.905	-0.494	-56.799	6.572	-55.465	11.717
-13.113	-14.301	-32.375	-7.456	-47.928	-0.479	-56.938	6.582	-55.449	11.716
-13.129	-14.289	-32.399	-7.444	-48	-0.469	-57.102	6.595	-55.435	11.715
-13.133	-14.279	-32.451	-7.434	-48.032	-0.456	-56.96	6.606	-55.442	11.716
-13.121	-14.261	-32.479	-7.427	-48.008	-0.447	-56.891	6.619	-55.431	11.714
-13.179	-14.248	-32.496	-7.419	-48.044	-0.436	-57.084	6.63	-55.443	11.715
-13.214	-14.24	-32.52	-7.411	-48.01	-0.423	-56.914	6.647	-55.415	11.715
-13.271	-14.227	-32.573	-7.401	-48.127	-0.415	-56.871	6.662	-55.415	11.715
-13.298	-14.221	-32.624	-7.391	-48.118	-0.406	-57.092	6.674	-55.41	11.715
-13.276	-14.211	-32.631	-7.379	-48.154	-0.398	-57.162	6.689	-55.412	11.716
-13.319	-14.205	-32.666	-7.368	-48.128	-0.389	-56.827	6.701	-55.404	11.717
-13.343	-14.193	-32.685	-7.352	-48.181	-0.378	-57.059	6.714	-55.405	11.716
-13.378	-14.185	-32.733	-7.339	-48.253	-0.365	-57.212	6.722	-55.402	11.715
-13.426	-14.17	-32.753	-7.325	-48.307	-0.352	-56.862	6.737	-55.402	11.715

Annex A

-13.434	-14.154	-32.836	-7.307	-48.343	-0.333	-57.068	6.746	-55.397	11.718
-13.443	-14.143	-32.842	-7.294	-48.365	-0.322	-57.249	6.755	-55.395	11.717
-13.417	-14.125	-32.895	-7.28	-48.429	-0.306	-56.985	6.769	-55.386	11.718
-13.443	-14.11	-32.904	-7.266	-48.458	-0.294	-57.086	6.778	-55.386	11.716
-13.465	-14.096	-32.96	-7.254	-48.495	-0.28	-57.29	6.79	-55.383	11.716
-13.518	-14.086	-33.023	-7.242	-48.529	-0.261	-57.112	6.806	-55.387	11.717
-13.529	-14.068	-33.088	-7.225	-48.571	-0.247	-57.145	6.82	-55.378	11.715
-13.613	-14.054	-33.143	-7.219	-48.581	-0.232	-57.326	6.834	-55.37	11.715
-13.649	-14.043	-33.183	-7.209	-48.587	-0.217	-57.296	6.847	-55.369	11.715
-13.677	-14.036	-33.209	-7.202	-48.62	-0.208	-57.28	6.861	-55.358	11.715
-13.302	-14.023	-33.253	-7.194	-48.633	-0.198	-57.43	6.876	-55.349	11.714
-13.345	-14.013	-33.306	-7.183	-48.659	-0.19	-57.494	6.892	-55.342	11.715
-13.389	-14.005	-33.344	-7.173	-48.692	-0.181	-57.158	6.908	-55.343	11.715
-13.425	-13.997	-33.405	-7.161	-48.684	-0.17	-57.334	6.916	-55.332	11.717
-13.424	-13.987	-33.454	-7.142	-48.743	-0.16	-57.524	6.928	-55.325	11.716
-13.422	-13.974	-33.482	-7.13	-48.754	-0.146	-57.269	6.943	-55.336	11.717
-13.405	-13.964	-33.508	-7.113	-48.824	-0.136	-57.455	6.951	-55.325	11.717
-13.414	-13.95	-33.529	-7.098	-48.825	-0.123	-57.608	6.962	-55.32	11.717
-13.453	-13.938	-33.547	-7.084	-48.821	-0.108	-57.526	6.973	-55.322	11.717
-13.47	-13.919	-33.577	-7.071	-48.846	-0.095	-57.471	6.983	-55.326	11.715
-13.5	-13.906	-33.6	-7.056	-48.834	-0.078	-57.597	6.994	-55.321	11.717
-13.519	-13.891	-33.637	-7.038	-48.922	-0.065	-57.641	7.007	-55.321	11.717
-13.547	-13.876	-33.652	-7.028	-48.932	-0.052	-57.371	7.017	-55.317	11.715
-13.535	-13.862	-33.674	-7.017	-48.956	-0.036	-57.567	7.031	-55.314	11.717
-13.556	-13.848	-33.696	-7.006	-48.966	-0.021	-57.739	7.044	-55.314	11.717
-13.593	-13.835	-33.727	-7.001	-49.003	-0.011	-57.49	7.062	-55.315	11.714
-13.606	-13.824	-33.74	-6.992	-49.088	0.003	-57.468	7.075	-55.297	11.715
-13.651	-13.812	-33.756	-6.984	-49.072	0.012	-57.65	7.086	-55.294	11.715
-13.674	-13.8	-33.77	-6.97	-49.018	0.025	-57.72	7.104	-55.294	11.715
-13.722	-13.794	-33.767	-6.963	-48.884	0.039	-57.554	7.118	-55.281	11.716
-13.743	-13.785	-33.781	-6.951	-48.935	0.05	-57.638	7.129	-55.282	11.716
-13.766	-13.775	-33.802	-6.936	-48.954	0.062	-57.818	7.142	-55.271	11.717
-13.777	-13.766	-33.833	-6.922	-48.971	0.071	-57.881	7.155	-55.276	11.718
-13.816	-13.758	-33.881	-6.907	-48.961	0.082	-57.739	7.164	-55.265	11.717
-13.84	-13.741	-33.898	-6.892	-48.972	0.089	-57.763	7.175	-55.268	11.717
-13.854	-13.727	-33.925	-6.874	-49.007	0.106	-57.876	7.186		
-13.892	-13.713	-33.972	-6.858	-49.07	0.117	-57.815	7.197		
-13.867	-13.696	-34.018	-6.844	-49.08	0.13	-57.755	7.209		

Table 8. Shear Trial 2 Results

Annex A

F (Kg)	D (mm)	F (Kg)	D (mm)	F (Kg)	D (mm)	F (Kg)	D (mm)	F (Kg)	D (mm)
0.004	-14.998	-13.408	-9.263	-21.503	-2.432	-25.155	4.494	-24.919	11.383
0	-14.99	-13.423	-9.249	-21.519	-2.412	-25.163	4.506	-24.915	11.396
0.005	-14.999	-13.428	-9.245	-21.512	-2.396	-25.159	4.509	-24.928	11.4
0.001	-14.996	-13.439	-9.218	-21.56	-2.397	-25.131	4.533	-24.962	11.424
0.011	-14.99	-13.462	-9.214	-21.561	-2.369	-25.127	4.541	-24.903	11.428
-0.001	-15	-13.503	-9.209	-21.57	-2.358	-25.151	4.551	-24.91	11.439
0.001	-14.996	-13.524	-9.179	-21.591	-2.36	-25.166	4.575	-24.843	11.462
0.021	-14.991	-13.555	-9.185	-21.581	-2.337	-25.172	4.577	-24.924	11.464
0.004	-15.001	-13.567	-9.17	-21.591	-2.326	-25.191	4.59	-24.894	11.479
-0.001	-14.995	-13.56	-9.143	-21.616	-2.32	-25.157	4.614	-24.91	11.499
0.006	-14.992	-13.579	-9.145	-21.623	-2.297	-25.178	4.614	-24.931	11.5
0.006	-15.001	-13.61	-9.129	-21.639	-2.289	-25.18	4.632	-24.931	11.52
0.012	-14.993	-13.625	-9.106	-21.661	-2.278	-25.148	4.649	-24.919	11.535
0.012	-14.994	-13.692	-9.107	-21.657	-2.256	-25.201	4.651	-24.899	11.535
-0.004	-14.999	-13.721	-9.086	-21.676	-2.255	-25.172	4.676	-24.882	11.56
0.009	-14.991	-13.717	-9.072	-21.686	-2.237	-25.191	4.685	-24.885	11.572
0.014	-14.997	-13.772	-9.074	-21.692	-2.22	-25.244	4.687	-24.882	11.575
-0.002	-14.999	-13.75	-9.045	-21.709	-2.219	-25.225	4.713	-24.877	11.598
0.01	-14.991	-13.755	-9.034	-21.742	-2.195	-25.239	4.719	-24.87	11.606
0.014	-15	-13.76	-9.034	-21.771	-2.18	-25.236	4.725	-24.823	11.616
-0.004	-14.999	-13.781	-9.006	-21.796	-2.182	-25.216	4.75	-24.812	11.639
0.007	-14.989	-13.804	-9	-21.802	-2.156	-25.229	4.755	-24.854	11.642
0.005	-15	-13.805	-8.995	-21.805	-2.143	-25.27	4.767	-24.88	11.657
0.001	-14.998	-13.79	-8.972	-21.845	-2.143	-25.252	4.789	-24.872	11.678
0.013	-14.992	-13.758	-8.965	-21.857	-2.116	-25.279	4.788	-24.784	11.679
0.015	-15	-13.743	-8.955	-21.858	-2.111	-25.254	4.807	-24.844	11.698
0.006	-14.996	-13.724	-8.933	-21.894	-2.106	-25.242	4.827	-24.807	11.714
0.016	-14.993	-13.745	-8.935	-21.888	-2.076	-25.255	4.824	-24.792	11.715
0.002	-15.001	-13.762	-8.915	-21.899	-2.076	-25.28	4.847	-24.851	11.734
0.009	-14.992	-13.776	-8.896	-21.92	-2.062	-25.261	4.862	-24.861	11.746
0.015	-14.995	-13.79	-8.896	-21.906	-2.039	-25.293	4.866	-24.889	11.751
0.003	-15.002	-13.792	-8.873	-21.929	-2.042	-25.252	4.89	-24.896	11.775
0.003	-14.991	-13.787	-8.862	-21.931	-2.023	-25.267	4.895	-24.856	11.782
0.012	-14.995	-13.799	-8.86	-21.893	-1.998	-25.297	4.904	-24.877	11.789
0	-15.002	-13.807	-8.835	-21.908	-2.003	-25.258	4.93	-24.922	11.813
0.011	-14.991	-13.796	-8.824	-21.9	-1.98	-25.264	4.935	-24.945	11.815

Annex A

0.015	-14.995	-13.813	-8.819	-21.87	-1.965	-25.288	4.942	-24.952	11.827
0.013	-14.999	-13.789	-8.794	-21.885	-1.962	-25.294	4.969	-24.874	11.853
0.015	-14.992	-13.795	-8.787	-21.895	-1.941	-25.322	4.971	-24.911	11.854
0.012	-14.999	-13.823	-8.782	-21.931	-1.933	-25.298	4.984	-24.843	11.869
0.004	-14.998	-13.792	-8.755	-21.973	-1.925	-25.267	5.004	-24.838	11.888
0.013	-14.99	-13.816	-8.753	-21.979	-1.899	-25.304	5.006	-24.857	11.892
0.01	-14.999	-13.838	-8.739	-22.001	-1.897	-25.318	5.029	-24.933	11.911
0.012	-14.996	-13.823	-8.714	-22.027	-1.887	-25.329	5.041	-24.884	11.922
0.019	-14.99	-13.835	-8.717	-22.027	-1.859	-25.346	5.041	-24.836	11.93
0.004	-15.001	-13.842	-8.7	-22.057	-1.862	-25.342	5.071	-24.908	11.953
0.006	-14.995	-13.858	-8.676	-22.1	-1.85	-25.329	5.077	-24.846	11.961
0.003	-14.992	-13.92	-8.682	-22.107	-1.826	-25.371	5.077	-24.825	11.966
0.011	-15.001	-13.961	-8.66	-22.117	-1.828	-25.372	5.103	-24.845	11.994
0.012	-14.994	-13.985	-8.65	-22.112	-1.806	-25.38	5.107	-24.834	11.996
0.005	-14.994	-14.021	-8.643	-22.114	-1.788	-25.383	5.12	-24.824	12.01
-0.006	-15	-14.037	-8.62	-22.124	-1.791	-25.367	5.143	-24.826	12.031
0.008	-14.991	-14.07	-8.612	-22.129	-1.761	-25.385	5.145	-24.79	12.032
0.014	-14.996	-14.136	-8.61	-22.129	-1.752	-25.389	5.161	-24.818	12.046
-0.004	-15	-14.175	-8.583	-22.143	-1.751	-25.348	5.181	-24.841	12.065
0.001	-14.99	-14.207	-8.575	-22.138	-1.726	-25.359	5.179	-24.848	12.07
0.019	-14.994	-14.244	-8.572	-22.139	-1.716	-25.363	5.202	-24.779	12.089
0.005	-15.001	-14.228	-8.544	-22.181	-1.711	-25.339	5.219	-24.768	12.101
-0.006	-14.996	-14.242	-8.537	-22.176	-1.681	-25.369	5.219	-24.786	12.102
0.017	-14.991	-14.261	-8.53	-22.223	-1.679	-25.347	5.246	-24.801	12.126
0.001	-15.004	-14.273	-8.508	-22.247	-1.667	-25.352	5.257	-24.816	12.135
-0.006	-14.992	-14.296	-8.508	-22.233	-1.643	-25.382	5.261	-24.786	12.136
0.017	-14.992	-14.304	-8.486	-22.244	-1.645	-25.359	5.287	-24.793	12.165
0.004	-15.004	-14.305	-8.471	-22.284	-1.625	-25.364	5.292	-24.788	12.171
-0.011	-14.993	-14.314	-8.472	-22.262	-1.607	-25.371	5.298	-24.836	12.182
-0.057	-14.994	-14.325	-8.446	-22.282	-1.607	-25.389	5.323	-24.831	12.201
-0.216	-14.999	-14.315	-8.434	-22.31	-1.585	-25.411	5.326	-24.813	12.206
-0.486	-14.99	-14.354	-8.434	-22.311	-1.574	-25.412	5.342	-24.82	12.222
-0.792	-14.995	-14.375	-8.411	-22.307	-1.574	-25.422	5.361	-24.814	12.241
-0.972	-14.996	-14.381	-8.401	-22.328	-1.551	-25.433	5.361	-24.745	12.24
-1.065	-14.987	-14.45	-8.397	-22.33	-1.538	-25.449	5.38	-24.773	12.266
-1.217	-14.999	-14.439	-8.369	-22.354	-1.538	-25.451	5.396	-24.776	12.278
-1.448	-14.996	-14.459	-8.363	-22.353	-1.513	-25.457	5.395	-24.774	12.28
-1.765	-14.985	-14.471	-8.355	-22.357	-1.506	-25.45	5.422	-24.82	12.303
-2.111	-14.995	-14.462	-8.333	-22.385	-1.497	-25.45	5.433	-24.718	12.312
-2.527	-14.991	-14.486	-8.331	-22.392	-1.47	-25.485	5.438	-24.761	12.318
-2.981	-14.979	-14.522	-8.317	-22.4	-1.474	-25.465	5.462	-24.743	12.342

Annex A

-3.45	-14.985	-14.524	-8.295	-22.385	-1.456	-25.433	5.467	-24.754	12.348
-3.89	-14.972	-14.526	-8.294	-22.367	-1.433	-25.483	5.476	-24.836	12.357
-4.275	-14.968	-14.542	-8.275	-22.42	-1.438	-25.435	5.501	-24.735	12.382
-4.661	-14.969	-14.546	-8.255	-22.454	-1.416	-25.446	5.503	-24.699	12.383
-4.984	-14.949	-14.588	-8.259	-22.447	-1.395	-25.442	5.515	-24.787	12.398
-5.285	-14.946	-14.589	-8.233	-22.477	-1.399	-25.402	5.542	-24.693	12.417
-5.614	-14.947	-14.602	-8.218	-22.47	-1.375	-25.414	5.54	-24.767	12.417
-5.912	-14.925	-14.64	-8.22	-22.447	-1.362	-25.404	5.557	-24.729	12.438
-6.224	-14.926	-14.632	-8.195	-22.467	-1.358	-25.397	5.579	-24.749	12.453
-6.547	-14.922	-14.632	-8.189	-22.446	-1.331	-25.439	5.578	-24.704	12.456
-6.81	-14.904	-14.676	-8.183	-22.449	-1.327	-25.454	5.598	-24.72	12.48
-7.091	-14.903	-14.691	-8.159	-22.481	-1.321	-25.449	5.611	-24.708	12.488
-7.287	-14.893	-14.711	-8.158	-22.492	-1.292	-25.46	5.613	-24.707	12.491
-7.49	-14.877	-14.752	-8.144	-22.512	-1.29	-25.448	5.64	-24.696	12.513
-7.677	-14.879	-14.745	-8.12	-22.53	-1.279	-25.438	5.646	-24.658	12.52
-7.807	-14.863	-14.757	-8.121	-22.542	-1.254	-25.436	5.652	-24.682	12.53
-7.862	-14.85	-14.779	-8.107	-22.578	-1.256	-25.43	5.68	-24.648	12.554
-7.923	-14.85	-14.762	-8.085	-22.591	-1.238	-25.407	5.684	-24.642	12.552
-7.995	-14.83	-14.804	-8.085	-22.604	-1.22	-25.424	5.694	-24.669	12.57
-8.012	-14.812	-14.835	-8.066	-22.634	-1.221	-25.387	5.715	-24.609	12.589
-8.066	-14.814	-14.842	-8.048	-22.65	-1.196	-25.404	5.718	-24.599	12.588
-8.109	-14.795	-14.88	-8.045	-22.644	-1.185	-25.433	5.737	-24.631	12.609
-8.075	-14.78	-14.912	-8.022	-22.665	-1.186	-25.376	5.754	-24.662	12.628
-8.014	-14.778	-14.916	-8.01	-22.645	-1.159	-25.416	5.756	-24.687	12.626
-7.897	-14.75	-14.912	-8.009	-22.664	-1.151	-25.414	5.776	-24.647	12.65
-7.771	-14.745	-14.831	-7.982	-22.693	-1.146	-25.402	5.791	-24.611	12.659
-7.678	-14.737	-14.848	-7.974	-22.692	-1.118	-25.422	5.795	-24.647	12.663
-7.54	-14.713	-14.888	-7.969	-22.706	-1.113	-25.415	5.821	-24.553	12.69
-7.425	-14.704	-14.886	-7.942	-22.734	-1.106	-25.406	5.827	-24.673	12.693
-7.336	-14.695	-14.901	-7.937	-22.735	-1.078	-25.428	5.832	-24.614	12.704
-7.211	-14.669	-14.948	-7.929	-22.75	-1.078	-25.417	5.858	-24.72	12.728
-7.165	-14.667	-14.945	-7.904	-22.765	-1.062	-25.398	5.861	-24.705	12.73
-7.148	-14.649	-14.958	-7.904	-22.77	-1.044	-25.416	5.87	-24.684	12.745
-7.114	-14.631	-14.965	-7.889	-22.777	-1.041	-25.415	5.894	-24.704	12.767
-7.103	-14.633	-14.947	-7.867	-22.79	-1.021	-25.392	5.895	-24.649	12.768
-7.064	-14.613	-14.946	-7.867	-22.781	-1.009	-25.419	5.908	-24.649	12.787
-6.963	-14.592	-14.956	-7.848	-22.829	-1.006	-25.382	5.93	-24.65	12.802
-6.915	-14.594	-14.926	-7.831	-22.826	-0.979	-25.393	5.932	-24.686	12.804
-6.894	-14.57	-14.963	-7.833	-22.805	-0.97	-25.387	5.951	-24.618	12.828
-6.868	-14.559	-14.981	-7.806	-22.801	-0.969	-25.362	5.969	-24.578	12.837
-6.895	-14.555	-14.998	-7.8	-22.816	-0.94	-25.373	5.965	-24.726	12.842

Annex A

-6.916	-14.532	-15.025	-7.795	-22.807	-0.934	-25.378	5.992	-24.604	12.867
-6.926	-14.524	-15.03	-7.769	-22.798	-0.926	-25.368	6.004	-24.608	12.871
-6.971	-14.518	-15.027	-7.763	-22.821	-0.902	-25.399	6.004	-24.524	12.878
-6.989	-14.49	-15.071	-7.757	-22.822	-0.901	-25.375	6.032	-24.562	12.903
-6.993	-14.485	-15.059	-7.73	-22.866	-0.882	-25.39	6.041	-24.575	12.904
-6.975	-14.479	-15.075	-7.727	-22.866	-0.861	-25.393	6.049	-24.568	12.921
-6.983	-14.456	-15.093	-7.714	-22.892	-0.862	-25.368	6.07	-24.557	12.941
-7.025	-14.454	-15.094	-7.69	-22.9	-0.843	-25.378	6.072	-24.528	12.937
-7.054	-14.442	-15.112	-7.692	-22.89	-0.823	-25.395	6.091	-24.485	12.961
-7.08	-14.42	-15.129	-7.672	-22.937	-0.827	-25.39	6.111	-24.642	12.974
-7.102	-14.421	-15.136	-7.655	-22.933	-0.801	-25.438	6.107	-24.53	12.975
-7.082	-14.402	-15.151	-7.656	-22.932	-0.788	-25.433	6.132	-24.484	13.001
-7.075	-14.386	-15.169	-7.633	-22.965	-0.786	-25.444	6.148	-24.542	13.009
-7.095	-14.388	-15.18	-7.616	-22.964	-0.763	-25.467	6.149	-24.574	13.012
-7.101	-14.364	-15.188	-7.62	-22.971	-0.754	-25.477	6.171	-24.532	13.04
-7.078	-14.352	-15.215	-7.595	-22.966	-0.746	-25.475	6.181	-24.516	13.047
-7.106	-14.352	-15.236	-7.584	-22.971	-0.72	-25.483	6.185	-24.621	13.053
-7.109	-14.328	-15.284	-7.579	-22.989	-0.719	-25.5	6.209	-24.453	13.081
-7.102	-14.315	-15.31	-7.556	-23.031	-0.708	-25.506	6.217	-24.363	13.084
-7.117	-14.313	-15.335	-7.553	-23.024	-0.682	-25.518	6.222	-24.499	13.096
-7.142	-14.286	-15.378	-7.541	-23.025	-0.686	-25.527	6.245	-24.475	13.117
-7.143	-14.28	-15.411	-7.514	-23.046	-0.667	-25.526	6.245	-24.453	13.121
-7.177	-14.27	-15.442	-7.516	-23.053	-0.648	-25.565	6.255	-24.535	13.141
-7.21	-14.246	-15.478	-7.503	-23.06	-0.647	-25.558	6.281	-24.504	13.154
-7.256	-14.245	-15.453	-7.474	-23.087	-0.627	-25.547	6.28	-24.533	13.156
-7.268	-14.234	-15.481	-7.479	-23.092	-0.612	-25.553	6.3	-24.545	13.179
-7.291	-14.209	-15.506	-7.461	-23.11	-0.607	-25.542	6.32	-24.495	13.191
-7.349	-14.21	-15.541	-7.441	-23.113	-0.585	-25.577	6.32	-24.514	13.193
-7.409	-14.194	-15.579	-7.444	-23.101	-0.574	-25.593	6.34	-24.463	13.218
-7.461	-14.176	-15.579	-7.42	-23.123	-0.569	-25.607	6.354	-24.547	13.225
-7.518	-14.175	-15.597	-7.413	-23.107	-0.539	-25.624	6.356	-24.582	13.233
-7.545	-14.157	-15.631	-7.409	-23.112	-0.539	-25.634	6.386	-24.461	13.258
-7.561	-14.142	-15.641	-7.381	-23.082	-0.527	-25.609	6.394	-24.51	13.257
-7.58	-14.143	-15.652	-7.375	-23.083	-0.502	-25.609	6.398	-24.498	13.269
-7.503	-14.119	-15.689	-7.372	-23.09	-0.501	-25.591	6.424	-24.443	13.293
-7.305	-14.103	-15.706	-7.344	-23.106	-0.484	-25.584	6.425	-24.514	13.29
-7.316	-14.102	-15.725	-7.339	-23.099	-0.465	-25.594	6.438	-24.46	13.312
-7.318	-14.075	-15.747	-7.329	-23.132	-0.466	-25.568	6.464	-24.531	13.329
-7.306	-14.068	-15.749	-7.31	-23.151	-0.443	-25.56	6.462	-24.444	13.328
-7.332	-14.062	-15.764	-7.307	-23.162	-0.43	-25.588	6.48	-24.484	13.353
-7.3	-14.041	-15.804	-7.293	-23.182	-0.429	-25.564	6.497	-24.493	13.361

Annex A

-7.284	-14.035	-15.809	-7.272	-23.153	-0.404	-25.565	6.5	-24.497	13.366
-7.323	-14.028	-15.86	-7.27	-23.14	-0.395	-25.584	6.522	-24.504	13.392
-7.313	-14.002	-15.865	-7.248	-23.194	-0.393	-25.563	6.534	-24.523	13.398
-7.334	-14.001	-15.891	-7.235	-23.192	-0.365	-25.568	6.539	-24.535	13.408
-7.359	-13.986	-15.91	-7.233	-23.218	-0.36	-25.558	6.564	-24.536	13.432
-7.351	-13.966	-15.926	-7.209	-23.243	-0.356	-25.562	6.568	-24.413	13.434
-7.355	-13.965	-15.901	-7.194	-23.241	-0.329	-25.581	6.574	-24.456	13.45
-7.39	-13.945	-15.929	-7.196	-23.232	-0.322	-25.55	6.603	-24.512	13.467
-7.385	-13.932	-15.937	-7.167	-23.233	-0.309	-25.544	6.608	-24.463	13.467
-7.435	-13.93	-15.939	-7.161	-23.225	-0.292	-25.568	6.615	-24.511	13.489
-7.448	-13.907	-15.963	-7.154	-23.277	-0.289	-25.557	6.637	-24.513	13.507
-7.45	-13.894	-15.975	-7.13	-23.272	-0.27	-25.566	6.637	-24.506	13.506
-7.454	-13.894	-15.992	-7.123	-23.249	-0.249	-25.554	6.656	-24.481	13.528
-7.454	-13.869	-16.034	-7.114	-23.283	-0.255	-25.523	6.675	-24.414	13.541
-7.478	-13.858	-16.035	-7.092	-23.292	-0.226	-25.549	6.674	-24.451	13.545
-7.515	-13.861	-16.045	-7.088	-23.285	-0.214	-25.54	6.7	-24.409	13.571
-7.534	-13.833	-16.073	-7.073	-23.309	-0.211	-25.533	6.712	-24.391	13.577
-7.566	-13.826	-16.053	-7.051	-23.307	-0.187	-25.533	6.712	-24.457	13.583
-7.567	-13.816	-16.071	-7.056	-23.323	-0.179	-25.539	6.737	-24.428	13.608
-7.447	-13.796	-16.111	-7.035	-23.342	-0.169	-25.505	6.747	-24.423	13.611
-7.45	-13.793	-16.124	-7.02	-23.35	-0.148	-25.498	6.752	-24.563	13.624
-7.473	-13.774	-16.154	-7.02	-23.365	-0.142	-25.488	6.78	-24.33	13.648
-7.465	-13.755	-16.159	-6.995	-23.362	-0.132	-25.439	6.782	-24.458	13.649
-7.489	-13.756	-16.145	-6.984	-23.353	-0.109	-25.479	6.793	-24.477	13.663
-7.506	-13.738	-16.153	-6.979	-23.381	-0.11	-25.479	6.817	-24.483	13.679
-7.495	-13.714	-16.159	-6.956	-23.384	-0.091	-25.472	6.817	-24.551	13.678
-7.492	-13.718	-16.15	-6.95	-23.371	-0.072	-25.504	6.835	-24.56	13.704
-7.48	-13.697	-16.174	-6.941	-23.403	-0.073	-25.501	6.853	-24.471	13.713
-7.449	-13.683	-16.154	-6.915	-23.422	-0.049	-25.479	6.853	-24.586	13.715
-7.42	-13.681	-16.157	-6.915	-23.415	-0.038	-25.485	6.875	-24.457	13.745
-7.41	-13.659	-16.16	-6.901	-23.445	-0.035	-25.438	6.892	-24.437	13.749
-7.383	-13.648	-16.146	-6.874	-23.43	-0.011	-25.453	6.89	-24.562	13.757
-7.403	-13.643	-16.155	-6.874	-23.432	-0.002	-25.475	6.917	-24.557	13.781
-7.379	-13.619	-16.183	-6.858	-23.475	0.001	-25.466	6.928	-24.45	13.784
-7.376	-13.613	-16.179	-6.837	-23.459	0.03	-25.49	6.935	-24.584	13.796
-7.409	-13.609	-16.18	-6.841	-23.471	0.034	-25.455	6.957	-24.325	13.82
-7.418	-13.582	-16.168	-6.818	-23.506	0.044	-25.408	6.964	-24.417	13.818
-7.448	-13.578	-16.159	-6.806	-23.474	0.07	-25.406	6.975	-24.485	13.84
-7.463	-13.57	-16.185	-6.802	-23.497	0.069	-25.438	6.997	-24.466	13.855
-7.459	-13.543	-16.193	-6.777	-23.515	0.089	-25.424	7.001	-24.51	13.854
-7.481	-13.541	-16.199	-6.768	-23.511	0.103	-25.454	7.017	-24.501	13.878

Annex A

-7.496	-13.529	-16.225	-6.765	-23.518	0.106	-25.438	7.033	-24.413	13.888
-7.499	-13.508	-16.237	-6.738	-23.545	0.126	-25.42	7.034	-24.459	13.892
-7.52	-13.509	-16.224	-6.733	-23.52	0.143	-25.364	7.054	-24.515	13.918
-7.555	-13.488	-16.255	-6.721	-23.514	0.143	-25.346	7.073	-24.521	13.923
-7.563	-13.47	-16.262	-6.698	-23.524	0.166	-25.356	7.071	-24.418	13.931
-7.613	-13.472	-16.281	-6.694	-23.517	0.177	-25.374	7.095	-24.467	13.958
-7.632	-13.447	-16.309	-6.681	-23.558	0.182	-25.368	7.105	-24.495	13.96
-7.625	-13.438	-16.334	-6.663	-23.543	0.209	-25.381	7.112	-24.427	13.972
-7.653	-13.435	-16.38	-6.661	-23.565	0.211	-25.4	7.133	-24.363	13.994
-7.666	-13.408	-16.415	-6.643	-23.597	0.221	-25.394	7.136	-24.432	13.995
-7.689	-13.401	-16.417	-6.63	-23.585	0.249	-25.403	7.151	-24.319	14.016
-7.717	-13.397	-16.462	-6.629	-23.604	0.248	-25.38	7.177	-24.406	14.031
-7.715	-13.371	-16.512	-6.603	-23.623	0.261	-25.424	7.176	-24.391	14.032
-7.709	-13.367	-16.516	-6.592	-23.608	0.286	-25.39	7.19	-24.4	14.053
-7.707	-13.359	-16.567	-6.592	-23.648	0.287	-25.361	7.213	-24.393	14.061
-7.686	-13.331	-16.618	-6.563	-23.625	0.303	-25.379	7.213	-24.333	14.068
-7.686	-13.335	-16.609	-6.555	-23.624	0.322	-25.383	7.231	-24.35	14.089
-7.687	-13.317	-16.641	-6.553	-23.666	0.322	-25.4	7.249	-24.335	14.099
-7.69	-13.294	-16.656	-6.526	-23.656	0.35	-25.407	7.25	-24.448	14.104
-7.721	-13.295	-16.686	-6.522	-23.681	0.359	-25.447	7.276	-24.305	14.131
-7.725	-13.279	-16.725	-6.513	-23.694	0.36	-25.478	7.284	-24.4	14.131
-7.724	-13.259	-16.731	-6.489	-23.679	0.386	-25.448	7.29	-24.453	14.146
-7.75	-13.261	-16.79	-6.488	-23.691	0.39	-25.407	7.314	-24.329	14.167
-7.757	-13.238	-16.806	-6.474	-23.719	0.4	-25.426	7.319	-24.419	14.168
-7.774	-13.223	-16.812	-6.449	-23.706	0.424	-25.44	7.331	-24.271	14.189
-7.785	-13.222	-16.859	-6.453	-23.728	0.427	-25.431	7.354	-24.311	14.208
-7.787	-13.196	-16.894	-6.435	-23.733	0.439	-25.418	7.357	-24.357	14.204
-7.797	-13.19	-16.908	-6.41	-23.742	0.461	-25.434	7.37	-24.374	14.227
-7.841	-13.185	-16.944	-6.417	-23.769	0.462	-25.399	7.393	-24.362	14.243
-7.858	-13.158	-16.971	-6.393	-23.759	0.48	-25.341	7.391	-24.31	14.242
-7.872	-13.158	-16.945	-6.378	-23.736	0.497	-25.351	7.412	-24.345	14.27
-7.912	-13.146	-16.979	-6.372	-23.775	0.495	-25.318	7.425	-24.327	14.271
-7.922	-13.12	-16.973	-6.347	-23.791	0.519	-25.398	7.429	-24.338	14.284
-7.939	-13.118	-16.98	-6.343	-23.771	0.536	-25.324	7.454	-24.001	14.312
-7.965	-13.111	-16.994	-6.334	-23.808	0.538	-25.371	7.46	-24.073	14.311
-7.946	-13.084	-16.984	-6.307	-23.815	0.561	-25.429	7.464	-24.164	14.329
-7.969	-13.087	-16.971	-6.305	-23.802	0.571	-25.439	7.491	-24.062	14.348
-7.993	-13.068	-16.981	-6.294	-23.839	0.575	-25.41	7.493	-24.118	14.348
-7.975	-13.051	-16.976	-6.27	-23.845	0.602	-25.42	7.503	-23.986	14.367
-8.003	-13.051	-16.995	-6.269	-23.846	0.609	-25.422	7.529	-24.013	14.384
-7.995	-13.028	-17.032	-6.258	-23.868	0.618	-25.417	7.534	-24.102	14.384

Annex A

-7.962	-13.011	-17.063	-6.237	-23.822	0.643	-25.385	7.546	-24.128	14.409
-7.977	-13.012	-17.138	-6.24	-23.846	0.642	-25.407	7.568	-23.919	14.418
-7.977	-12.988	-17.157	-6.219	-23.817	0.663	-25.428	7.569	-24.091	14.424
-7.97	-12.973	-17.166	-6.202	-23.847	0.681	-25.412	7.592	-23.989	14.448
-7.995	-12.974	-17.181	-6.204	-23.846	0.68	-25.394	7.601	-24.075	14.446
-8.009	-12.946	-17.172	-6.177	-23.844	0.702	-25.365	7.607	-24.115	14.458
-8.003	-12.942	-17.185	-6.169	-23.872	0.72	-25.392	7.633	-24.073	14.483
-8.018	-12.933	-17.241	-6.166	-23.88	0.718	-25.385	7.641	-24.04	14.483
-8.028	-12.909	-17.267	-6.139	-23.897	0.741	-25.376	7.644	-23.948	14.498
-8.029	-12.908	-17.291	-6.131	-23.873	0.752	-25.38	7.667	-24.072	14.523
-8.053	-12.893	-17.309	-6.126	-23.876	0.757	-25.363	7.676	-24.066	14.52
-8.051	-12.875	-17.301	-6.098	-23.861	0.777	-25.38	7.687	-24.057	14.541
-8.075	-12.873	-17.316	-6.097	-23.868	0.782	-25.385	7.707	-23.998	14.558
-8.099	-12.857	-17.336	-6.083	-23.896	0.796	-25.421	7.709	-23.977	14.558
-8.101	-12.838	-17.353	-6.059	-23.881	0.822	-25.429	7.728	-24.062	14.584
-8.128	-12.843	-17.417	-6.061	-23.895	0.821	-25.391	7.745	-24.105	14.592
-8.15	-12.821	-17.455	-6.044	-23.916	0.836	-25.415	7.745	-24.123	14.599
-8.164	-12.806	-17.46	-6.025	-23.912	0.859	-25.441	7.768	-24.143	14.624
-8.202	-12.807	-17.503	-6.022	-23.921	0.861	-25.453	7.785	-23.974	14.628
-8.228	-12.78	-17.523	-6	-23.945	0.875	-25.46	7.787	-24.041	14.636
-8.256	-12.769	-17.546	-5.987	-23.939	0.893	-25.409	7.804	-24.086	14.656
-8.281	-12.766	-17.602	-5.99	-23.963	0.896	-25.405	7.815	-24.1	14.662
-8.288	-12.743	-17.607	-5.963	-23.975	0.919	-25.416	7.822	-23.928	14.677
-8.302	-12.738	-17.649	-5.953	-23.974	0.933	-25.398	7.846	-23.995	14.697
-8.366	-12.728	-17.685	-5.95	-23.984	0.935	-25.428	7.851	-24.064	14.695
-8.387	-12.701	-17.701	-5.924	-24	0.963	-25.419	7.861	-24.117	14.718
-8.407	-12.699	-17.701	-5.918	-24.026	0.967	-25.445	7.884	-24.143	14.731
-8.426	-12.691	-17.749	-5.912	-24.035	0.975	-25.47	7.888	-24.027	14.733
-8.421	-12.663	-17.756	-5.888	-24.017	0.999	-25.497	7.9	-24.117	14.758
-8.464	-12.667	-17.786	-5.884	-24.054	1	-25.448	7.921	-24.005	14.765
-8.49	-12.654	-17.819	-5.871	-24.064	1.016	-25.419	7.921	-24.113	14.77
-8.507	-12.63	-17.823	-5.854	-24.064	1.037	-25.498	7.943	-24.093	14.794
-8.548	-12.629	-17.841	-5.853	-24.097	1.036	-25.504	7.961	-23.955	14.803
-8.587	-12.613	-17.866	-5.833	-24.105	1.056	-25.539	7.96	-24.159	14.809
-8.617	-12.592	-17.865	-5.813	-24.1	1.073	-25.512	7.982	-23.867	14.835
-8.674	-12.596	-17.914	-5.813	-24.144	1.073	-25.537	7.993	-24.03	14.833
-8.725	-12.569	-17.909	-5.791	-24.161	1.097	-25.576	7.997	-24.08	14.85
-8.739	-12.561	-17.943	-5.779	-24.172	1.106	-25.554	8.021	-23.881	14.873
-8.835	-12.561	-17.987	-5.774	-24.202	1.116	-25.512	8.025	-24.204	14.868
-8.875	-12.532	-17.996	-5.75	-24.22	1.138	-25.536	8.039	-23.902	14.893
-8.924	-12.526	-17.983	-5.746	-24.224	1.145	-25.553	8.059	-24.014	14.905

Annex A

-8.956	-12.521	-18.01	-5.738	-24.231	1.151	-25.574	8.063	-24.031	14.908
-8.95	-12.497	-18.037	-5.711	-24.204	1.177	-25.58	8.077	-23.866	14.933
-8.976	-12.496	-18.064	-5.711	-24.205	1.18	-25.548	8.101	-23.909	14.94
-9.003	-12.487	-18.085	-5.7	-24.219	1.185	-25.525	8.1	-24.065	14.944
-8.996	-12.461	-18.087	-5.672	-24.202	1.209	-25.443	8.119	-24.144	14.971
-9.045	-12.459	-18.101	-5.671	-24.182	1.209	-25.442	8.135	-23.774	14.978
-9.079	-12.444	-18.117	-5.66	-24.177	1.229	-25.494	8.142	-24.129	14.982
-9.065	-12.421	-18.141	-5.635	-24.192	1.24	-25.492	8.165	-23.943	15.007
-9.078	-12.423	-18.181	-5.638	-24.203	1.245	-25.528	8.172	-24.035	15.011
-9.108	-12.404	-18.18	-5.616	-24.22	1.271	-25.503	8.179	-24.011	15.026
-9.117	-12.388	-18.193	-5.601	-24.202	1.28	-25.443	8.2	-23.899	15.043
-9.153	-12.388	-18.201	-5.599	-24.236	1.284	-25.474	8.204	-23.956	15.044
-9.156	-12.366	-18.195	-5.573	-24.221	1.307	-25.493	8.215	-24.051	15.072
-9.144	-12.35	-18.243	-5.565	-24.218	1.317	-25.495	8.24	-23.945	15.082
-9.151	-12.353	-18.275	-5.56	-24.207	1.325	-25.423	8.241	-23.874	15.082
-9.165	-12.326	-18.268	-5.534	-24.19	1.349	-25.39	8.254	-23.974	15.108
-9.121	-12.316	-18.27	-5.526	-24.183	1.357	-25.383	8.276	-23.947	15.117
-9.116	-12.316	-18.263	-5.52	-24.186	1.371	-25.405	8.278	-23.895	15.124
-9.134	-12.289	-18.267	-5.494	-24.174	1.39	-25.426	8.295	-23.897	15.143
-9.132	-12.285	-18.294	-5.491	-24.195	1.392	-25.391	8.313	-24.03	15.15
-9.164	-12.272	-18.307	-5.481	-24.203	1.41	-25.359	8.312	-23.953	15.166
-9.172	-12.247	-18.35	-5.461	-24.175	1.429	-25.379	8.341	-23.856	15.185
-9.207	-12.247	-18.396	-5.458	-24.197	1.43	-25.354	8.348	-23.868	15.185
-9.268	-12.238	-18.431	-5.442	-24.209	1.451	-25.385	8.354	-23.993	15.206
-9.306	-12.214	-18.451	-5.427	-24.194	1.468	-25.373	8.379	-24.051	15.22
-9.328	-12.213	-18.496	-5.426	-24.246	1.468	-25.349	8.384	-23.722	15.223
-9.367	-12.197	-18.523	-5.401	-24.265	1.492	-25.382	8.394	-24.088	15.242
-9.394	-12.172	-18.535	-5.389	-24.271	1.502	-25.362	8.419	-23.791	15.254
-9.422	-12.178	-18.589	-5.392	-24.297	1.509	-25.421	8.421	-23.926	15.26
-9.437	-12.158	-18.599	-5.364	-24.283	1.534	-25.407	8.434	-23.957	15.28
-9.453	-12.144	-18.62	-5.355	-24.293	1.539	-25.371	8.455	-23.743	15.288
-9.507	-12.141	-18.644	-5.349	-24.304	1.55	-25.452	8.457	-23.875	15.297
-9.542	-12.118	-18.649	-5.326	-24.291	1.568	-25.457	8.477	-23.783	15.323
-9.584	-12.111	-18.657	-5.321	-24.298	1.572	-25.415	8.49	-23.943	15.321
-9.606	-12.11	-18.663	-5.31	-24.298	1.588	-25.429	8.493	-24.034	15.334
-9.6	-12.082	-18.66	-5.287	-24.278	1.607	-25.429	8.519	-23.596	15.362
-9.571	-12.074	-18.639	-5.283	-24.283	1.607	-25.431	8.527	-23.887	15.359
-9.506	-12.075	-18.628	-5.266	-24.307	1.627	-25.437	8.531	-23.878	15.378
-9.504	-12.044	-18.607	-5.244	-24.292	1.645	-25.445	8.557	-23.929	15.396
-9.552	-12.04	-18.624	-5.247	-24.311	1.646	-25.417	8.564	-24.028	15.397
-9.603	-12.029	-18.593	-5.225	-24.311	1.67	-25.359	8.572	-23.586	15.424

Annex A

-9.628	-12.008	-18.495	-5.207	-24.344	1.68	-25.362	8.593	-23.939	15.432
-9.625	-12.005	-18.502	-5.208	-24.37	1.688	-25.344	8.598	-23.849	15.436
-9.672	-11.989	-18.546	-5.184	-24.345	1.71	-25.368	8.609	-23.737	15.463
-9.692	-11.971	-18.569	-5.173	-24.365	1.714	-25.388	8.631	-23.63	15.469
-9.725	-11.972	-18.613	-5.171	-24.39	1.726	-25.379	8.63	-23.677	15.479
-9.76	-11.951	-18.616	-5.144	-24.363	1.752	-25.369	8.654	-23.79	15.499
-9.772	-11.929	-18.638	-5.137	-24.392	1.751	-25.361	8.666	-23.804	15.503
-9.82	-11.935	-18.67	-5.133	-24.39	1.767	-25.392	8.667	-23.565	15.52
-9.834	-11.906	-18.657	-5.107	-24.372	1.79	-25.415	8.692	-23.743	15.536
-9.843	-11.898	-18.709	-5.104	-24.408	1.789	-25.386	8.705	-23.73	15.537
-9.887	-11.896	-18.768	-5.092	-24.399	1.807	-25.369	8.71	-23.593	15.558
-9.903	-11.871	-18.776	-5.072	-24.384	1.823	-25.389	8.733	-23.629	15.576
-9.904	-11.862	-18.79	-5.07	-24.421	1.826	-25.387	8.738	-23.73	15.574
-9.933	-11.855	-18.827	-5.055	-24.439	1.85	-25.41	8.751	-23.755	15.599
-9.921	-11.831	-18.814	-5.033	-24.446	1.855	-25.36	8.773	-23.444	15.609
-9.92	-11.825	-18.853	-5.034	-24.487	1.862	-25.363	8.776	-23.743	15.608
-9.929	-11.82	-18.905	-5.014	-24.493	1.887	-25.329	8.792	-23.578	15.633
-9.909	-11.795	-18.906	-5	-24.487	1.896	-25.284	8.812	-23.642	15.637
-9.93	-11.793	-18.961	-4.998	-24.486	1.899	-25.271	8.814	-23.631	15.648
-9.976	-11.78	-18.98	-4.974	-24.483	1.926	-25.266	8.831	-23.55	15.672
-9.986	-11.755	-18.983	-4.964	-24.484	1.929	-25.291	8.849	-23.747	15.672
-10.013	-11.76	-19.005	-4.961	-24.49	1.941	-25.305	8.851	-23.81	15.687
-10.045	-11.74	-18.995	-4.932	-24.485	1.959	-25.308	8.872	-23.429	15.71
-10.046	-11.722	-19.042	-4.926	-24.51	1.965	-25.337	8.884	-23.652	15.712
-10.095	-11.723	-19.095	-4.924	-24.517	1.982	-25.364	8.888	-23.72	15.73
-10.082	-11.705	-19.119	-4.892	-24.526	1.998	-25.289	8.913	-23.498	15.747
-10.059	-11.687	-19.145	-4.889	-24.541	1.997	-25.327	8.919	-23.617	15.749
-10.022	-11.686	-19.175	-4.878	-24.532	2.021	-25.368	8.927	-23.702	15.775
-10.041	-11.658	-19.155	-4.857	-24.524	2.035	-25.39	8.952	-23.595	15.781
-10.054	-11.65	-19.187	-4.857	-24.546	2.039	-25.408	8.954	-23.686	15.786
-10.084	-11.646	-19.195	-4.837	-24.547	2.064	-25.35	8.97	-23.639	15.81
-10.084	-11.618	-19.212	-4.821	-24.564	2.073	-25.303	8.987	-23.745	15.812
-10.12	-11.617	-19.18	-4.82	-24.548	2.08	-25.361	8.987	-23.604	15.827
-10.173	-11.61	-19.014	-4.795	-24.546	2.102	-25.383	9.007	-23.563	15.848
-10.155	-11.583	-18.981	-4.782	-24.57	2.107	-25.287	9.024	-23.657	15.851
-10.176	-11.58	-19.025	-4.781	-24.569	2.123	-25.371	9.025	-23.712	15.865
-10.199	-11.574	-19.017	-4.755	-24.577	2.141	-25.346	9.045	-23.401	15.886
-10.226	-11.546	-19.023	-4.742	-24.609	2.144	-25.359	9.058	-23.531	15.887
-10.266	-11.545	-19.072	-4.742	-24.614	2.161	-25.422	9.064	-23.667	15.909
-10.292	-11.531	-19.08	-4.716	-24.592	2.177	-25.367	9.087	-23.471	15.924
-10.319	-11.509	-19.095	-4.708	-24.609	2.18	-25.356	9.092	-23.617	15.927

Annex A

-10.352	-11.514	-19.098	-4.704	-24.613	2.203	-25.368	9.105	-23.746	15.949
-10.379	-11.488	-19.099	-4.681	-24.628	2.214	-25.375	9.129	-23.671	15.956
-10.385	-11.474	-19.131	-4.683	-24.648	2.219	-25.384	9.13	-23.48	15.964
-10.429	-11.476	-19.141	-4.667	-24.657	2.246	-25.303	9.142	-23.645	15.986
-10.424	-11.453	-19.137	-4.645	-24.619	2.253	-25.31	9.165	-23.645	15.993
-10.43	-11.441	-19.157	-4.646	-24.641	2.259	-25.351	9.168	-23.471	16.001
-10.487	-11.434	-19.187	-4.626	-24.616	2.281	-25.367	9.182	-23.638	16.02
-10.513	-11.412	-19.219	-4.605	-24.629	2.285	-25.381	9.201	-23.758	16.027
-10.547	-11.405	-19.255	-4.611	-24.639	2.301	-25.384	9.203	-23.408	16.044
-10.584	-11.395	-19.28	-4.588	-24.635	2.326	-25.325	9.227	-23.681	16.056
-10.592	-11.37	-19.318	-4.577	-24.646	2.324	-25.308	9.235	-23.704	16.059
-10.62	-11.37	-19.347	-4.572	-24.655	2.341	-25.327	9.241	-23.518	16.084
-10.649	-11.356	-19.365	-4.546	-24.638	2.36	-25.306	9.266	-23.674	16.093
-10.658	-11.335	-19.381	-4.543	-24.671	2.361	-25.336	9.272	-23.786	16.096
-10.697	-11.336	-19.406	-4.532	-24.688	2.38	-25.362	9.281	-23.558	16.124
-10.737	-11.322	-19.376	-4.506	-24.659	2.396	-25.342	9.306	-23.619	16.133
-10.719	-11.3	-19.372	-4.505	-24.661	2.401	-25.336	9.31	-23.258	16.14
-10.747	-11.301	-19.442	-4.494	-24.69	2.424	-25.338	9.324	-23.102	16.141
-10.759	-11.282	-19.424	-4.47	-24.654	2.431	-25.334	9.343	-22.998	16.141
-10.752	-11.265	-19.465	-4.467	-24.632	2.438	-25.312	9.346	-22.924	16.143
-10.775	-11.264	-19.458	-4.453	-24.644	2.466	-25.311	9.364	-22.857	16.145
-10.767	-11.242	-19.471	-4.429	-24.652	2.468	-25.176	9.379	-22.793	16.143
-10.79	-11.231	-19.491	-4.429	-24.7	2.477	-25.186	9.382	-22.746	16.142
-10.833	-11.228	-19.5	-4.41	-24.706	2.503	-25.172	9.403	-22.698	16.147
-10.832	-11.203	-19.501	-4.391	-24.691	2.505	-25.129	9.414	-22.642	16.146
-10.83	-11.195	-19.506	-4.394	-24.718	2.517	-25.096	9.418	-22.626	16.144
-10.876	-11.189	-19.487	-4.369	-24.7	2.538	-25.114	9.441	-22.59	16.144
-10.874	-11.159	-19.5	-4.357	-24.694	2.541	-25.123	9.449	-22.558	16.147
-10.895	-11.158	-19.546	-4.355	-24.717	2.56	-25.185	9.455	-22.523	16.15
-10.937	-11.146	-19.539	-4.328	-24.715	2.574	-25.134	9.482	-22.507	16.144
-10.942	-11.122	-19.564	-4.325	-24.743	2.579	-25.155	9.484	-22.482	16.146
-10.954	-11.124	-19.6	-4.32	-24.711	2.604	-25.142	9.497	-22.443	16.152
-10.984	-11.11	-19.627	-4.291	-24.695	2.613	-25.088	9.516	-22.439	16.141
-10.996	-11.088	-19.637	-4.293	-24.716	2.619	-25.085	9.522	-22.41	16.148
-11.031	-11.085	-19.639	-4.279	-24.696	2.643	-25.057	9.542	-22.354	16.154
-11.058	-11.064	-19.64	-4.258	-24.711	2.646	-25.061	9.553	-22.372	16.141
-11.068	-11.052	-19.666	-4.256	-24.763	2.659	-25.133	9.557	-22.336	16.149
-11.099	-11.051	-19.712	-4.238	-24.757	2.681	-25.162	9.582	-22.303	16.153
-11.125	-11.028	-19.708	-4.224	-24.773	2.685	-25.086	9.594	-22.291	16.147
-11.14	-11.017	-19.757	-4.219	-24.758	2.696	-25.102	9.597	-22.284	16.148
-11.192	-11.015	-19.782	-4.196	-24.765	2.721	-25.099	9.62	-22.244	16.149

Annex A

-11.212	-10.988	-19.767	-4.182	-24.767	2.722	-25.098	9.628	-22.241	16.149
-11.227	-10.979	-19.798	-4.181	-24.811	2.735	-25.148	9.639	-22.233	16.148
-11.259	-10.974	-19.782	-4.158	-24.839	2.752	-25.172	9.661	-22.213	16.148
-11.266	-10.953	-19.782	-4.144	-24.861	2.753	-25.177	9.664	-22.188	16.149
-11.278	-10.947	-19.817	-4.141	-24.85	2.779	-25.151	9.68	-22.179	16.149
-11.315	-10.94	-19.806	-4.113	-24.829	2.787	-25.116	9.699	-22.168	16.15
-11.33	-10.915	-19.796	-4.11	-24.872	2.791	-25.084	9.702	-22.152	16.149
-11.386	-10.913	-19.839	-4.101	-24.864	2.819	-25.086	9.72	-22.138	16.15
-11.417	-10.9	-19.813	-4.081	-24.901	2.824	-25.117	9.739	-22.12	16.149
-11.414	-10.877	-19.848	-4.075	-24.918	2.828	-25.117	9.739	-22.098	16.148
-11.396	-10.879	-19.869	-4.061	-24.922	2.856	-25.1	9.756	-22.109	16.151
-11.208	-10.859	-19.904	-4.038	-24.889	2.861	-25.115	9.765	-22.087	16.151
-11.18	-10.842	-19.955	-4.041	-24.855	2.872	-25.126	9.772	-22.081	16.149
-11.178	-10.841	-19.978	-4.021	-24.83	2.892	-24.995	9.794	-22.057	16.15
-11.173	-10.819	-19.998	-4	-24.831	2.9	-25.017	9.799	-22.058	16.145
-11.151	-10.804	-19.986	-4.002	-24.83	2.914	-25.03	9.812	-22.04	16.156
-11.167	-10.802	-19.995	-3.981	-24.787	2.934	-25.022	9.837	-22.012	16.147
-11.161	-10.78	-19.983	-3.968	-24.81	2.934	-25.041	9.839	-22.035	16.146
-11.164	-10.771	-20.02	-3.963	-24.762	2.959	-25.028	9.852	-22.011	16.158
-11.19	-10.766	-20.012	-3.94	-24.75	2.971	-25.039	9.873	-21.995	16.146
-11.21	-10.738	-20.036	-3.93	-24.744	2.973	-25.111	9.878	-21.982	16.15
-11.225	-10.737	-20.055	-3.924	-24.71	2.997	-25.183	9.893	-21.977	16.153
-11.281	-10.729	-20.008	-3.896	-24.722	3.009	-25.152	9.91	-21.958	16.148
-11.274	-10.699	-20.027	-3.894	-24.794	3.015	-25.157	9.91	-21.941	16.153
-11.286	-10.698	-20.051	-3.887	-24.741	3.037	-25.175	9.936	-21.944	16.15
-11.297	-10.69	-20.033	-3.862	-24.752	3.043	-25.136	9.943	-21.952	16.15
-11.312	-10.665	-20.046	-3.86	-24.769	3.052	-25.178	9.951	-21.921	16.152
-11.353	-10.665	-20.036	-3.841	-24.745	3.076	-25.142	9.974	-21.915	16.151
-11.366	-10.648	-20.041	-3.823	-24.78	3.077	-25.077	9.981	-21.91	16.15
-11.386	-10.625	-20.038	-3.82	-24.797	3.091	-25.116	9.993	-21.905	16.15
-11.42	-10.628	-20.051	-3.805	-24.794	3.112	-25.052	10.015	-21.88	16.153
-11.443	-10.605	-20.061	-3.787	-24.812	3.11	-25.058	10.017	-21.892	16.15
-11.443	-10.59	-20.117	-3.787	-24.824	3.126	-25.054	10.028	-21.879	16.151
-11.51	-10.592	-20.132	-3.761	-24.8	3.146	-24.989	10.054	-21.855	16.154
-11.542	-10.568	-20.108	-3.75	-24.82	3.148	-25.007	10.053	-21.864	16.148
-11.568	-10.559	-20.127	-3.749	-24.812	3.169	-25.04	10.071	-21.857	16.152
-11.607	-10.556	-20.138	-3.72	-24.831	3.178	-25.113	10.087	-21.836	16.156
-11.617	-10.531	-20.14	-3.718	-24.868	3.187	-25.105	10.094	-21.825	16.148
-11.587	-10.524	-20.164	-3.71	-24.872	3.21	-25.054	10.111	-21.827	16.153
-11.597	-10.52	-20.183	-3.685	-24.894	3.216	-25.063	10.119	-21.803	16.153
-11.597	-10.495	-20.201	-3.679	-24.916	3.227	-25.044	10.131	-21.798	16.151

Annex A

-11.615	-10.493	-20.217	-3.668	-24.916	3.249	-25.062	10.148	-21.789	16.151
-11.641	-10.48	-20.242	-3.645	-24.911	3.25	-25.051	10.155	-21.79	16.153
-11.627	-10.459	-20.259	-3.642	-24.909	3.265	-25.042	10.167	-21.767	16.155
-11.66	-10.455	-20.29	-3.626	-24.903	3.287	-25.022	10.193	-21.766	16.151
-11.675	-10.438	-20.319	-3.607	-24.879	3.29	-25.078	10.193	-21.767	16.151
-11.663	-10.419	-20.356	-3.612	-24.877	3.306	-25.14	10.205	-21.752	16.154
-11.703	-10.422	-20.361	-3.584	-24.863	3.326	-25.109	10.227	-21.747	16.151
-11.728	-10.4	-20.336	-3.569	-24.914	3.327	-25.06	10.23	-21.74	16.154
-11.73	-10.38	-20.375	-3.57	-24.933	3.347	-25.034	10.25	-21.718	16.153
-11.753	-10.384	-20.383	-3.545	-24.93	3.356	-25.046	10.261	-21.728	16.148
-11.766	-10.359	-20.396	-3.534	-24.972	3.364	-25.07	10.267	-21.716	16.157
-11.77	-10.343	-20.43	-3.532	-24.967	3.387	-25.022	10.291	-21.712	16.154
-11.806	-10.344	-20.451	-3.51	-24.944	3.395	-24.966	10.3	-21.698	16.146
-11.813	-10.32	-20.484	-3.5	-24.936	3.402	-24.997	10.304	-21.698	16.158
-11.839	-10.314	-20.522	-3.495	-24.929	3.426	-25.061	10.328	-21.683	16.156
-11.885	-10.303	-20.474	-3.469	-24.94	3.432	-25.022	10.337	-21.691	16.146
-11.898	-10.281	-20.501	-3.469	-24.973	3.441	-24.992	10.345	-21.676	16.158
-11.907	-10.276	-20.516	-3.455	-24.942	3.464	-24.985	10.366	-21.667	16.154
-11.899	-10.268	-20.51	-3.431	-24.971	3.469	-25.044	10.37	-21.669	16.149
-11.817	-10.237	-20.506	-3.432	-24.998	3.487	-24.983	10.383	-21.647	16.159
-11.875	-10.243	-20.568	-3.413	-24.993	3.502	-24.927	10.407	-21.647	16.151
-11.926	-10.224	-20.55	-3.397	-24.989	3.499	-24.94	10.407	-21.651	16.151
-11.943	-10.203	-20.567	-3.395	-24.983	3.526	-25.012	10.424	-21.627	16.162
-11.961	-10.204	-20.573	-3.372	-24.963	3.535	-25.005	10.444	-21.621	16.151
-11.987	-10.182	-20.593	-3.359	-24.993	3.538	-24.96	10.446	-21.627	16.15
-11.977	-10.17	-20.624	-3.358	-24.983	3.562	-24.954	10.463	-21.612	16.158
-12.022	-10.17	-20.636	-3.329	-24.982	3.572	-24.954	10.479	-21.601	16.155
-12.055	-10.149	-20.644	-3.318	-24.983	3.578	-24.914	10.481	-21.602	16.154
-12.07	-10.133	-20.669	-3.318	-24.938	3.602	-24.943	10.507	-21.598	16.153
-12.101	-10.132	-20.634	-3.289	-24.931	3.609	-24.901	10.515	-21.597	16.154
-12.08	-10.103	-20.668	-3.288	-24.953	3.621	-24.856	10.522	-21.594	16.154
-12.047	-10.097	-20.688	-3.276	-24.95	3.642	-24.812	10.545	-21.575	16.155
-12.065	-10.094	-20.711	-3.251	-24.977	3.645	-24.868	10.546	-21.585	16.154
-12.1	-10.066	-20.731	-3.25	-24.983	3.661	-24.861	10.561	-21.586	16.154
-12.127	-10.06	-20.744	-3.235	-24.996	3.678	-24.841	10.579	-21.561	16.156
-12.171	-10.055	-20.757	-3.213	-25.022	3.679	-24.844	10.583	-21.567	16.155
-12.207	-10.029	-20.785	-3.215	-25.014	3.7	-24.85	10.601	-21.558	16.154
-12.238	-10.028	-20.796	-3.198	-25.016	3.714	-24.795	10.617	-21.545	16.154
-12.266	-10.015	-20.82	-3.179	-25.029	3.718	-24.854	10.616	-21.553	16.156
-12.289	-9.993	-20.846	-3.178	-25.022	3.743	-24.818	10.64	-21.544	16.156
-12.328	-9.995	-20.863	-3.154	-25.012	3.754	-24.758	10.658	-21.537	16.154

Annex A

-12.372	-9.974	-20.889	-3.144	-25.012	3.757	-24.83	10.656	-21.528	16.154
-12.372	-9.957	-20.905	-3.14	-25.025	3.782	-24.845	10.677	-21.51	16.156
-12.422	-9.959	-20.887	-3.118	-25.049	3.788	-24.908	10.687	-21.507	16.156
-12.427	-9.936	-20.885	-3.112	-25.065	3.799	-24.889	10.696	-21.497	16.154
-12.405	-9.92	-20.931	-3.105	-25.063	3.822	-24.858	10.719	-21.517	16.154
-12.433	-9.922	-20.935	-3.078	-25.095	3.823	-24.892	10.724	-21.495	16.156
-12.479	-9.897	-20.962	-3.073	-25.091	3.839	-24.866	10.738	-21.494	16.156
-12.5	-9.885	-20.952	-3.065	-25.097	3.857	-24.778	10.759	-21.481	16.152
-12.555	-9.882	-20.914	-3.041	-25.101	3.858	-24.795	10.761	-21.482	16.154
-12.557	-9.853	-20.901	-3.039	-25.112	3.877	-24.79	10.776	-21.473	16.156
-12.577	-9.85	-20.912	-3.02	-25.106	3.897	-24.808	10.798	-21.489	16.156
-12.584	-9.84	-20.9	-3.007	-25.129	3.894	-24.795	10.799	-21.474	16.155
-12.612	-9.817	-20.938	-3.004	-25.111	3.915	-24.797	10.819	-21.466	16.155
-12.626	-9.814	-20.961	-2.98	-25.095	3.926	-24.836	10.834	-21.453	16.158
-12.674	-9.803	-20.939	-2.964	-25.106	3.934	-24.809	10.836	-21.451	16.156
-12.691	-9.779	-20.969	-2.968	-25.11	3.958	-24.773	10.859	-21.453	16.153
-12.727	-9.779	-20.986	-2.941	-25.09	3.962	-24.831	10.868	-21.46	16.154
-12.758	-9.764	-20.993	-2.933	-25.131	3.972	-24.844	10.875	-21.444	16.156
-12.738	-9.745	-21.006	-2.928	-25.111	3.996	-24.902	10.898	-21.417	16.159
-12.775	-9.745	-21.015	-2.905	-25.109	3.998	-24.905	10.903	-21.433	16.15
-12.802	-9.724	-21.035	-2.899	-25.109	4.013	-24.914	10.916	-21.429	16.16
-12.815	-9.713	-21.07	-2.888	-25.092	4.034	-24.819	10.937	-21.409	16.159
-12.864	-9.712	-21.066	-2.865	-25.117	4.037	-24.883	10.934	-21.422	16.15
-12.871	-9.682	-21.076	-2.861	-25.115	4.053	-24.833	10.953	-21.413	16.161
-12.865	-9.678	-21.077	-2.847	-25.111	4.075	-24.797	10.97	-21.403	16.155
-12.904	-9.673	-21.066	-2.825	-25.122	4.077	-24.795	10.97	-21.402	16.152
-12.888	-9.647	-21.087	-2.826	-25.119	4.099	-24.77	10.988	-21.4	16.162
-12.882	-9.636	-21.104	-2.805	-25.125	4.111	-24.76	11.005	-21.4	16.15
-12.913	-9.63	-21.103	-2.788	-25.11	4.115	-24.795	11.009	-21.394	16.156
-12.926	-9.606	-21.138	-2.787	-25.114	4.14	-24.775	11.031	-21.375	16.162
-12.969	-9.603	-21.139	-2.76	-25.101	4.147	-24.792	11.04	-21.388	16.15
-13.01	-9.588	-21.148	-2.751	-25.115	4.152	-24.763	11.048	-21.386	16.158
-13.027	-9.564	-21.16	-2.751	-25.114	4.18	-24.767	11.073	-21.372	16.16
-13.054	-9.567	-21.141	-2.728	-25.085	4.182	-24.793	11.078	-21.377	16.15
-13.077	-9.547	-21.14	-2.719	-25.107	4.192	-24.82	11.087	-21.376	16.163
-13.067	-9.529	-21.17	-2.709	-25.095	4.219	-24.734	11.115	-21.351	16.156
-13.106	-9.53	-21.171	-2.688	-25.114	4.218	-24.738	11.113	-21.369	16.15
-13.14	-9.511	-21.19	-2.685	-25.101	4.235	-24.771	11.13	-21.35	16.162
-13.109	-9.493	-21.214	-2.669	-25.103	4.253	-24.762	11.146	-21.353	16.156
-13.128	-9.495	-21.196	-2.65	-25.119	4.255	-24.701	11.152	-21.349	16.153
-13.137	-9.47	-21.234	-2.651	-25.106	4.278	-24.75	11.17	-21.333	16.162

Annex A

-13.133	-9.457	-21.269	-2.633	-25.097	4.292	-24.733	11.185	-21.344	16.152
-13.151	-9.459	-21.275	-2.612	-25.112	4.292	-24.785	11.185	-21.331	16.156
-13.128	-9.428	-21.304	-2.612	-25.119	4.313	-24.761	11.21	-21.331	16.162
-13.133	-9.423	-21.313	-2.592	-25.096	4.323	-24.78	11.222	-21.335	16.15
-13.155	-9.417	-21.306	-2.578	-25.128	4.332	-24.859	11.221	-21.336	16.158
-13.135	-9.392	-21.334	-2.572	-25.095	4.356	-24.804	11.249	-21.325	16.164
-13.166	-9.392	-21.356	-2.549	-25.133	4.363	-24.746	11.256	-21.332	16.151
-13.197	-9.376	-21.367	-2.539	-25.134	4.371	-24.841	11.263	-21.323	16.159
-13.217	-9.359	-21.397	-2.538	-25.112	4.394	-24.841	11.286	-21.306	16.16
-13.259	-9.361	-21.388	-2.507	-25.134	4.398	-24.858	11.29	-21.337	16.151
-13.266	-9.338	-21.417	-2.501	-25.136	4.413	-24.809	11.305	-21.292	16.162
-13.248	-9.32	-21.459	-2.499	-25.121	4.432	-24.832	11.32	-21.301	16.156
-13.262	-9.321	-21.472	-2.47	-25.164	4.434	-24.864	11.321	-21.323	16.153
-13.278	-9.298	-21.49	-2.467	-25.156	4.456	-24.805	11.342	-21.268	16.165
-13.3	-9.283	-21.493	-2.455	-25.156	4.471	-24.818	11.359	-21.295	16.154
-13.351	-9.285	-21.493	-2.432	-25.168	4.469	-24.866	11.36	-21.299	16.153

Table 9. Shear Trial 3 Results

F (Kg)	D (mm)	F (Kg)	D (mm)	F (Kg)	D (mm)	F (Kg)	D (mm)	F (Kg)	D (mm)
-0.176	-19.924	-19.524	-11.355	-34.301	-1.648	-42.449	8.161	-45.435	14.717
-0.178	-19.918	-19.542	-11.34	-34.336	-1.645	-42.418	8.179	-45.183	14.734
-0.163	-19.922	-19.374	-11.339	-34.363	-1.619	-42.362	8.198	-45.289	14.735
-0.168	-19.922	-18.907	-11.313	-34.414	-1.616	-42.334	8.197	-45.367	14.757
-0.16	-19.918	-18.931	-11.304	-34.438	-1.601	-42.261	8.224	-45.241	14.769
-0.173	-19.925	-18.96	-11.291	-34.448	-1.584	-42.241	8.225	-45.208	14.779
-0.181	-19.92	-18.93	-11.272	-34.484	-1.578	-42.237	8.24	-45.321	14.797
-0.169	-19.918	-18.913	-11.269	-34.508	-1.559	-42.181	8.261	-45.204	14.8
-0.178	-19.925	-18.888	-11.247	-34.521	-1.557	-42.16	8.261	-45.251	14.819
-0.173	-19.917	-18.914	-11.237	-34.618	-1.548	-42.097	8.287	-45.306	14.833
-0.168	-19.922	-18.981	-11.233	-34.652	-1.524	-42.057	8.295	-45.343	14.835
-0.166	-19.923	-18.988	-11.209	-34.689	-1.526	-42.079	8.303	-45.412	14.859
-0.164	-19.92	-18.988	-11.204	-34.709	-1.504	-42.038	8.329	-45.378	14.863
-0.17	-19.924	-18.994	-11.187	-34.728	-1.491	-42.041	8.326	-45.266	14.877
-0.17	-19.921	-18.986	-11.172	-34.787	-1.484	-42.04	8.351	-45.467	14.891
-0.168	-19.92	-19.051	-11.169	-34.804	-1.461	-42.035	8.36	-45.318	14.9
-0.178	-19.924	-19.081	-11.141	-34.84	-1.462	-42.08	8.367	-45.524	14.916
-0.166	-19.917	-19.095	-11.137	-34.9	-1.444	-42.034	8.396	-45.692	14.925
-0.165	-19.924	-19.126	-11.128	-34.931	-1.422	-42.051	8.394	-45.208	14.937
-0.173	-19.924	-19.09	-11.104	-34.968	-1.425	-42.067	8.413	-45.512	14.958

Annex A

-0.165	-19.918	-19.138	-11.103	-34.971	-1.399	-42.088	8.429	-45.637	14.959
-0.173	-19.924	-19.096	-11.084	-34.99	-1.391	-42.139	8.429	-45.694	14.978
-0.166	-19.92	-19.111	-11.072	-35.04	-1.384	-42.13	8.456	-45.588	14.99
-0.166	-19.921	-19.133	-11.067	-35.057	-1.362	-42.139	8.459	-45.556	14.998
-0.176	-19.924	-19.135	-11.04	-35.082	-1.364	-42.181	8.472	-45.599	15.02
-0.156	-19.917	-19.174	-11.039	-35.101	-1.34	-42.216	8.495	-45.58	15.021
-0.168	-19.925	-19.19	-11.024	-35.093	-1.327	-42.23	8.492	-45.451	15.041
-0.182	-19.924	-19.195	-11.006	-35.134	-1.322	-42.225	8.517	-45.735	15.057
-0.171	-19.918	-19.211	-11.005	-35.131	-1.296	-42.219	8.524	-45.71	15.054
-0.158	-19.925	-19.247	-10.978	-35.13	-1.294	-42.224	8.533	-45.628	15.084
-0.162	-19.919	-19.283	-10.976	-35.102	-1.274	-42.207	8.552	-45.599	15.089
-0.167	-19.922	-19.314	-10.964	-35.07	-1.259	-42.209	8.558	-45.686	15.097
-0.187	-19.923	-19.338	-10.946	-35.128	-1.259	-42.238	8.576	-45.36	15.123
-0.169	-19.919	-19.387	-10.946	-35.131	-1.232	-42.218	8.592	-45.735	15.121
-0.167	-19.926	-19.405	-10.923	-35.164	-1.225	-42.242	8.59	-45.711	15.144
-0.167	-19.922	-19.403	-10.914	-35.196	-1.217	-42.234	8.616	-45.345	15.156
-0.151	-19.918	-19.429	-10.908	-35.174	-1.191	-42.201	8.624	-45.548	15.159
-0.172	-19.925	-19.44	-10.885	-35.183	-1.194	-42.169	8.632	-45.76	15.182
-0.165	-19.92	-19.464	-10.882	-35.193	-1.175	-42.144	8.656	-45.112	15.192
-0.172	-19.922	-19.504	-10.867	-35.224	-1.165	-42.161	8.655	-45.59	15.203
-0.159	-19.923	-19.477	-10.847	-35.3	-1.158	-42.143	8.681	-45.648	15.218
-0.158	-19.917	-19.496	-10.847	-35.3	-1.134	-42.135	8.688	-45.352	15.224
-0.164	-19.926	-19.526	-10.824	-35.334	-1.131	-42.149	8.694	-45.674	15.242
-0.162	-19.921	-19.524	-10.816	-35.346	-1.114	-42.159	8.722	-45.264	15.252
-0.167	-19.92	-19.559	-10.813	-35.359	-1.096	-42.178	8.722	-45.599	15.26
-0.172	-19.926	-19.619	-10.783	-35.418	-1.097	-42.184	8.738	-45.509	15.284
-0.166	-19.919	-19.627	-10.78	-35.469	-1.075	-42.196	8.755	-45.449	15.283
-0.157	-19.923	-19.639	-10.764	-35.552	-1.066	-42.196	8.756	-45.728	15.302
-0.157	-19.924	-19.69	-10.751	-35.592	-1.056	-42.239	8.783	-45.336	15.316
-0.171	-19.92	-19.703	-10.747	-35.602	-1.034	-42.266	8.785	-45.678	15.318
-0.168	-19.925	-19.76	-10.723	-35.602	-1.033	-42.309	8.798	-45.76	15.341
-0.163	-19.921	-19.839	-10.723	-35.58	-1.012	-42.304	8.821	-45.461	15.349
-0.163	-19.922	-19.944	-10.71	-35.59	-0.998	-42.304	8.818	-45.573	15.363
-0.162	-19.926	-20.005	-10.685	-35.636	-0.995	-42.299	8.845	-45.466	15.384
-0.157	-19.917	-20.071	-10.69	-35.658	-0.969	-42.303	8.852	-45.316	15.387
-0.16	-19.924	-20.104	-10.666	-35.724	-0.968	-42.31	8.859	-45.531	15.408
-0.183	-19.926	-20.13	-10.659	-35.764	-0.95	-42.284	8.886	-45.304	15.42
-0.296	-19.918	-20.22	-10.649	-35.759	-0.934	-42.295	8.886	-45.505	15.424
-0.378	-19.921	-20.279	-10.625	-35.832	-0.938	-42.332	8.907	-45.588	15.445
-0.457	-19.927	-20.342	-10.626	-35.856	-0.905	-42.363	8.917	-45.207	15.449
-0.721	-19.917	-20.426	-10.607	-35.914	-0.902	-42.368	8.919	-45.405	15.471

Annex A

-1.359	-19.924	-20.437	-10.592	-35.975	-0.891	-42.359	8.948	-45.6	15.478
-2.043	-19.915	-20.468	-10.59	-36.019	-0.87	-42.393	8.952	-45.142	15.49
-2.664	-19.914	-20.506	-10.567	-36.039	-0.869	-42.457	8.967	-45.491	15.513
-3.272	-19.919	-20.546	-10.562	-36.035	-0.848	-42.472	8.981	-45.429	15.514
-3.748	-19.898	-20.624	-10.555	-36.077	-0.838	-42.532	8.984	-45.358	15.531
-4.182	-19.904	-20.664	-10.534	-36.122	-0.833	-42.559	9.007	-45.639	15.543
-4.569	-19.898	-20.745	-10.533	-36.148	-0.806	-42.594	9.01	-45.276	15.55
-4.869	-19.881	-20.764	-10.515	-36.191	-0.806	-42.653	9.021	-45.619	15.573
-5.158	-19.881	-20.781	-10.504	-36.253	-0.785	-42.688	9.042	-45.737	15.575
-5.425	-19.867	-20.811	-10.499	-36.28	-0.776	-42.711	9.045	-45.24	15.592
-5.523	-19.859	-20.821	-10.472	-36.301	-0.774	-42.718	9.064	-45.696	15.608
-3.949	-19.868	-20.874	-10.475	-36.324	-0.748	-42.725	9.077	-45.66	15.608
-2.696	-19.864	-20.925	-10.458	-36.35	-0.741	-42.767	9.081	-45.367	15.627
-2.59	-19.871	-20.933	-10.438	-36.417	-0.731	-42.773	9.108	-45.623	15.637
-2.585	-19.874	-20.958	-10.437	-36.448	-0.712	-42.843	9.106	-45.889	15.644
-2.858	-19.867	-20.912	-10.41	-36.502	-0.711	-42.907	9.125	-45.644	15.664
-3.553	-19.875	-20.927	-10.41	-36.529	-0.685	-42.9	9.141	-45.617	15.668
-4.298	-19.861	-20.978	-10.394	-36.528	-0.677	-42.952	9.143	-45.752	15.684
-5.082	-19.862	-20.971	-10.374	-36.544	-0.673	-42.939	9.166	-45.722	15.701
-5.678	-19.864	-21.026	-10.374	-36.533	-0.645	-42.978	9.176	-45.513	15.707
-5.97	-19.841	-21.079	-10.352	-36.557	-0.642	-43.044	9.183	-45.97	15.725
-6.203	-19.842	-21.079	-10.344	-36.573	-0.628	-43.073	9.209	-45.968	15.732
-6.411	-19.831	-21.114	-10.334	-36.558	-0.611	-43.123	9.205	-45.599	15.75
-6.625	-19.815	-21.111	-10.313	-36.582	-0.606	-43.155	9.23	-45.831	15.766
-6.841	-19.818	-21.146	-10.311	-36.54	-0.58	-43.185	9.237	-46.01	15.765
-7.042	-19.792	-21.172	-10.294	-36.532	-0.576	-43.206	9.246	-45.517	15.792
-7.231	-19.791	-21.176	-10.272	-36.555	-0.566	-43.211	9.268	-45.93	15.8
-7.418	-19.782	-21.2	-10.274	-36.551	-0.543	-43.22	9.271	-46.109	15.801
-7.548	-19.759	-21.196	-10.25	-36.574	-0.54	-43.223	9.289	-45.529	15.832
-7.68	-19.76	-21.207	-10.245	-36.565	-0.519	-43.217	9.303	-45.974	15.828
-7.832	-19.741	-21.185	-10.233	-36.519	-0.509	-43.254	9.309	-46.116	15.845
-7.942	-19.725	-21.182	-10.213	-36.509	-0.5	-43.249	9.333	-45.414	15.867
-8.066	-19.726	-21.217	-10.212	-36.519	-0.477	-43.221	9.337	-45.976	15.866
-8.148	-19.703	-21.262	-10.189	-36.55	-0.477	-43.224	9.35	-46.247	15.888
-8.16	-19.694	-21.275	-10.177	-36.572	-0.457	-43.208	9.369	-45.62	15.897
-8.191	-19.686	-21.297	-10.175	-36.587	-0.438	-43.226	9.37	-46.011	15.91
-8.16	-19.665	-21.281	-10.148	-36.643	-0.439	-43.187	9.391	-46.116	15.931
-8.128	-19.665	-21.329	-10.147	-36.638	-0.414	-43.166	9.397	-45.705	15.929
-8.041	-19.64	-21.358	-10.135	-36.623	-0.405	-43.184	9.408	-46.009	15.952
-7.974	-19.627	-21.379	-10.114	-36.633	-0.399	-43.185	9.431	-46.31	15.961
-7.966	-19.628	-21.433	-10.116	-36.628	-0.377	-43.212	9.429	-45.853	15.969

Annex A

-7.911	-19.599	-21.451	-10.09	-36.68	-0.378	-43.257	9.451	-46.063	15.991
-7.872	-19.594	-21.481	-10.083	-36.698	-0.353	-43.246	9.464	-46.17	15.992
-7.871	-19.582	-21.466	-10.077	-36.708	-0.345	-43.296	9.466	-45.613	16.011
-7.845	-19.562	-21.468	-10.051	-36.751	-0.337	-43.327	9.49	-45.818	16.021
-7.821	-19.56	-21.441	-10.051	-36.758	-0.312	-43.367	9.495	-45.881	16.025
-7.721	-19.531	-21.413	-10.033	-36.798	-0.313	-43.398	9.512	-45.479	16.055
-7.579	-19.529	-21.422	-10.015	-36.835	-0.296	-43.385	9.528	-45.87	16.06
-7.513	-19.523	-21.452	-10.014	-36.84	-0.282	-43.43	9.53	-45.995	16.066
-7.46	-19.494	-21.442	-9.991	-36.906	-0.275	-43.46	9.552	-45.38	16.094
-7.439	-19.496	-21.461	-9.989	-36.94	-0.252	-43.484	9.561	-45.845	16.092
-7.447	-19.479	-21.499	-9.97	-36.959	-0.245	-43.542	9.569	-45.874	16.114
-7.43	-19.464	-21.47	-9.956	-37.013	-0.238	-43.576	9.592	-45.347	16.128
-7.464	-19.461	-21.513	-9.955	-37.035	-0.214	-43.603	9.594	-45.477	16.132
-7.478	-19.437	-21.54	-9.928	-37.071	-0.211	-43.594	9.612	-45.596	16.157
-7.48	-19.434	-21.556	-9.92	-37.112	-0.191	-43.615	9.626	-45.463	16.161
-7.51	-19.423	-21.575	-9.913	-37.158	-0.183	-43.64	9.628	-45.459	16.178
-7.522	-19.399	-21.562	-9.892	-37.227	-0.175	-43.631	9.656	-45.543	16.191
-7.533	-19.398	-21.593	-9.891	-37.25	-0.15	-43.657	9.658	-45.509	16.197
-7.536	-19.378	-21.597	-9.865	-37.281	-0.151	-43.687	9.675	-45.349	16.217
-7.536	-19.367	-21.582	-9.856	-37.322	-0.131	-43.689	9.691	-45.399	16.225
-7.59	-19.363	-21.627	-9.855	-37.341	-0.115	-43.643	9.692	-45.442	16.239
-7.606	-19.34	-21.627	-9.825	-37.387	-0.114	-43.647	9.717	-45.519	16.259
-7.662	-19.335	-21.618	-9.823	-37.398	-0.087	-43.673	9.724	-45.565	16.259
-7.668	-19.324	-21.627	-9.81	-37.419	-0.086	-43.698	9.735	-45.346	16.286
-7.675	-19.303	-21.624	-9.794	-37.413	-0.073	-43.711	9.753	-45.605	16.291
-7.758	-19.305	-21.658	-9.789	-37.417	-0.049	-43.705	9.752	-45.452	16.299
-7.811	-19.28	-21.659	-9.766	-37.45	-0.054	-43.704	9.774	-45.392	16.323
-7.851	-19.271	-21.653	-9.761	-37.483	-0.027	-43.719	9.782	-45.684	16.322
-7.889	-19.267	-21.681	-9.753	-37.514	-0.021	-43.774	9.792	-45.584	16.344
-7.89	-19.24	-21.666	-9.729	-37.546	-0.014	-43.762	9.814	-45.523	16.357
-7.945	-19.242	-21.695	-9.728	-37.537	0.009	-43.767	9.818	-45.681	16.358
-7.979	-19.226	-21.689	-9.712	-37.563	0.011	-43.776	9.835	-45.558	16.386
-7.997	-19.209	-21.716	-9.693	-37.596	0.029	-43.782	9.848	-45.581	16.387
-8.072	-19.208	-21.803	-9.693	-37.637	0.044	-43.816	9.851	-45.52	16.401
-8.085	-19.179	-21.803	-9.664	-37.691	0.045	-43.784	9.879	-45.615	16.417
-8.07	-19.18	-21.808	-9.664	-37.7	0.073	-43.789	9.882	-45.76	16.419
-8.087	-19.168	-21.814	-9.646	-37.687	0.079	-43.833	9.893	-45.355	16.448
-8.078	-19.147	-21.799	-9.63	-37.733	0.09	-43.838	9.916	-45.651	16.448
-8.117	-19.146	-21.833	-9.629	-37.728	0.111	-43.878	9.917	-45.821	16.459
-8.133	-19.128	-21.842	-9.604	-37.752	0.109	-43.905	9.938	-45.327	16.488
-8.123	-19.117	-21.856	-9.595	-37.771	0.134	-43.937	9.949	-45.734	16.485

Annex A

-8.169	-19.111	-21.902	-9.59	-37.764	0.141	-43.943	9.953	-45.587	16.503
-8.173	-19.084	-21.886	-9.563	-37.821	0.149	-43.917	9.979	-45.34	16.519
-8.173	-19.085	-21.904	-9.562	-37.833	0.173	-43.939	9.979	-45.688	16.522
-8.192	-19.073	-21.913	-9.543	-37.845	0.174	-43.947	9.997	-45.651	16.548
-8.214	-19.05	-21.915	-9.53	-37.835	0.195	-43.926	10.014	-45.554	16.55
-8.243	-19.05	-21.961	-9.528	-37.798	0.21	-43.944	10.019	-45.39	16.566
-8.236	-19.029	-21.949	-9.498	-37.826	0.211	-43.956	10.043	-45.418	16.586
-8.137	-19.021	-21.959	-9.496	-37.836	0.235	-44	10.045	-45.612	16.584
-8.128	-19.012	-21.975	-9.484	-37.883	0.24	-44.022	10.059	-45.4	16.609
-8.053	-18.983	-21.942	-9.464	-37.932	0.256	-44.016	10.077	-45.787	16.617
-8.061	-18.987	-21.992	-9.465	-37.917	0.276	-44.019	10.08	-45.144	16.628
-8.083	-18.968	-22.004	-9.437	-37.916	0.276	-44.069	10.102	-45.683	16.646
-8.1	-18.945	-22.035	-9.431	-37.915	0.302	-44.045	10.11	-45.272	16.652
-8.136	-18.95	-22.101	-9.424	-37.946	0.309	-44.024	10.119	-45.645	16.669
-8.14	-18.921	-22.103	-9.398	-37.996	0.315	-43.987	10.141	-45.261	16.687
-8.141	-18.918	-22.127	-9.398	-38.029	0.342	-44.011	10.144	-45.771	16.684
-8.204	-18.907	-22.129	-9.383	-38.093	0.342	-44.041	10.162	-45.703	16.713
-8.193	-18.884	-22.14	-9.371	-38.099	0.365	-44.012	10.173	-45.378	16.715
-8.236	-18.883	-22.175	-9.368	-38.08	0.374	-43.994	10.182	-45.439	16.729
-8.269	-18.859	-22.167	-9.342	-38.114	0.376	-43.903	10.203	-45.868	16.746
-8.265	-18.849	-22.17	-9.339	-38.114	0.402	-43.841	10.207	-45.947	16.743
-8.297	-18.847	-22.185	-9.328	-38.161	0.402	-43.824	10.221	-45.242	16.776
-8.314	-18.819	-22.16	-9.303	-38.217	0.416	-43.816	10.245	-45.82	16.776
-8.367	-18.818	-22.162	-9.306	-38.22	0.436	-43.79	10.243	-45.896	16.783
-8.4	-18.807	-22.187	-9.283	-38.233	0.437	-43.692	10.268	-45.424	16.807
-8.411	-18.784	-22.201	-9.272	-38.223	0.463	-43.645	10.274	-45.619	16.808
-8.434	-18.782	-22.234	-9.269	-38.225	0.469	-43.634	10.288	-45.978	16.824
-8.418	-18.76	-22.243	-9.242	-38.256	0.477	-43.594	10.306	-45.72	16.839
-8.389	-18.757	-22.268	-9.241	-38.274	0.501	-43.559	10.308	-45.518	16.851
-8.422	-18.759	-22.298	-9.224	-38.312	0.499	-43.521	10.333	-45.87	16.867
-8.421	-18.731	-22.283	-9.204	-38.303	0.523	-43.456	10.343	-46.159	16.867
-8.331	-18.728	-22.309	-9.207	-38.261	0.536	-43.436	10.35	-45.385	16.892
-7.955	-18.712	-22.328	-9.181	-38.244	0.537	-43.38	10.372	-45.968	16.908
-7.956	-18.693	-22.342	-9.177	-38.2	0.565	-43.348	10.377	-46.228	16.902
-7.988	-18.688	-22.392	-9.166	-38.219	0.569	-43.294	10.395	-45.522	16.933
-7.988	-18.663	-22.392	-9.142	-38.22	0.583	-43.23	10.41	-45.739	16.94
-7.999	-18.661	-22.45	-9.143	-38.215	0.602	-43.21	10.412	-46.094	16.947
-8.044	-18.651	-22.425	-9.116	-38.187	0.605	-43.183	10.437	-46.02	16.969
-8.054	-18.627	-22.425	-9.109	-38.159	0.632	-43.155	10.447	-45.534	16.975
-8.089	-18.628	-22.473	-9.103	-38.104	0.637	-43.108	10.455	-46.131	16.99
-8.113	-18.609	-22.475	-9.076	-38.079	0.647	-43.055	10.476	-46.424	16.999

Annex A

-8.135	-18.597	-22.506	-9.077	-38.071	0.67	-43.056	10.481	-45.388	17.013
-8.193	-18.592	-22.533	-9.061	-38.088	0.673	-43.02	10.501	-45.989	17.035
-8.197	-18.567	-22.544	-9.042	-38.092	0.693	-42.999	10.509	-46.323	17.033
-8.247	-18.567	-22.585	-9.039	-38.084	0.707	-43.018	10.52	-45.764	17.053
-8.299	-18.552	-22.621	-9.019	-38.085	0.708	-43.025	10.539	-45.873	17.075
-8.33	-18.531	-22.649	-9.014	-38.04	0.739	-43.049	10.539	-46.043	17.072
-8.367	-18.535	-22.711	-9.001	-38.002	0.737	-43.054	10.556	-46.309	17.093
-8.391	-18.508	-22.754	-8.982	-38.003	0.757	-43.051	10.573	-45.52	17.104
-8.407	-18.5	-22.816	-8.986	-38.015	0.771	-43.063	10.574	-46.128	17.112
-8.448	-18.494	-22.875	-8.963	-38.047	0.77	-43.055	10.6	-45.648	17.139
-8.422	-18.469	-22.889	-8.951	-38.046	0.799	-43.06	10.604	-46.079	17.132
-8.462	-18.468	-22.959	-8.944	-37.99	0.806	-43.056	10.621	-45.905	17.161
-8.518	-18.451	-22.986	-8.92	-37.925	0.816	-43.039	10.635	-46.092	17.169
-8.558	-18.437	-23.057	-8.922	-37.89	0.839	-43.046	10.639	-46.171	17.171
-8.61	-18.432	-23.153	-8.905	-37.927	0.839	-43.053	10.662	-45.779	17.197
-8.648	-18.407	-23.192	-8.884	-37.978	0.864	-43.029	10.672	-46.185	17.194
-8.673	-18.404	-23.256	-8.889	-38.043	0.872	-43.014	10.683	-45.956	17.217
-8.736	-18.394	-23.303	-8.861	-38.111	0.878	-43.023	10.699	-46.055	17.229
-8.784	-18.373	-23.368	-8.856	-38.118	0.902	-43.061	10.705	-45.826	17.233
-8.85	-18.374	-23.421	-8.845	-38.139	0.902	-43.081	10.725	-45.825	17.26
-8.877	-18.355	-23.445	-8.826	-38.147	0.921	-43.075	10.737	-46.073	17.261
-8.897	-18.343	-23.517	-8.825	-38.169	0.937	-43.117	10.74	-45.511	17.279
-8.945	-18.34	-23.558	-8.798	-38.226	0.942	-43.139	10.763	-45.878	17.295
-8.97	-18.313	-23.584	-8.791	-38.248	0.965	-43.152	10.77	-45.787	17.299
-9.003	-18.312	-23.638	-8.788	-38.28	0.971	-43.155	10.784	-45.456	17.325
-9.065	-18.3	-23.675	-8.761	-38.324	0.98	-43.151	10.802	-45.808	17.33
-9.107	-18.277	-23.718	-8.764	-38.234	1.004	-43.178	10.804	-45.774	17.337
-9.174	-18.277	-23.767	-8.744	-38.199	1.004	-43.155	10.827	-45.439	17.363
-9.206	-18.258	-23.723	-8.725	-38.196	1.027	-43.135	10.834	-45.665	17.367
-9.223	-18.251	-23.734	-8.724	-38.184	1.035	-43.174	10.846	-45.582	17.382
-9.284	-18.24	-23.757	-8.7	-38.226	1.046	-43.158	10.866	-45.438	17.4
-9.306	-18.213	-23.792	-8.695	-38.213	1.071	-43.192	10.869	-45.526	17.405
-9.358	-18.219	-23.847	-8.682	-38.203	1.07	-43.243	10.889	-45.805	17.425
-9.398	-18.202	-23.882	-8.662	-38.176	1.09	-43.296	10.899	-45.654	17.427
-9.262	-18.184	-23.964	-8.662	-38.132	1.107	-43.342	10.908	-45.426	17.447
-9.226	-18.181	-23.991	-8.642	-38.123	1.108	-43.392	10.928	-45.642	17.464
-9.2	-18.158	-24.004	-8.628	-38.091	1.131	-43.439	10.931	-45.681	17.464
-9.251	-18.15	-24.051	-8.624	-38.074	1.137	-43.475	10.944	-45.446	17.491
-9.276	-18.14	-24.061	-8.602	-38.111	1.153	-43.456	10.96	-45.846	17.498
-9.28	-18.115	-24.104	-8.602	-38.066	1.172	-43.483	10.964	-45.832	17.504
-9.31	-18.118	-24.127	-8.585	-38.111	1.169	-43.492	10.989	-45.428	17.531

Annex A

-9.322	-18.094	-24.142	-8.566	-38.123	1.194	-43.541	10.992	-45.612	17.531
-9.317	-18.081	-24.172	-8.565	-38.125	1.204	-43.464	11.005	-45.766	17.549
-9.336	-18.079	-24.181	-8.541	-38.158	1.211	-43.442	11.026	-45.34	17.563
-9.355	-18.054	-24.178	-8.535	-38.148	1.234	-43.189	11.031	-45.854	17.563
-9.385	-18.052	-24.182	-8.526	-38.193	1.235	-42.735	11.046	-45.859	17.587
-9.397	-18.041	-24.203	-8.5	-38.171	1.26	-42.553	11.041	-45.578	17.593
-9.413	-18.021	-24.263	-8.503	-38.141	1.269	-42.429	11.042	-45.846	17.604
-9.454	-18.019	-24.301	-8.481	-38.156	1.271	-42.342	11.047	-45.733	17.623
-9.495	-17.996	-24.295	-8.467	-38.139	1.301	-42.276	11.044	-45.715	17.625
-9.508	-17.987	-24.325	-8.468	-38.178	1.303	-42.207	11.041	-45.791	17.651
-9.54	-17.983	-24.354	-8.44	-38.205	1.317	-42.149	11.045	-45.817	17.655
-9.557	-17.958	-24.376	-8.438	-38.228	1.337	-42.102	11.047	-45.872	17.663
-9.605	-17.96	-24.406	-8.421	-38.254	1.334	-42.064	11.044	-45.625	17.693
-9.625	-17.943	-24.434	-8.405	-38.24	1.363	-42.019	11.042	-46.038	17.688
-9.617	-17.926	-24.479	-8.406	-38.268	1.368	-41.988	11.048	-46.08	17.707
-9.66	-17.924	-24.494	-8.379	-38.319	1.378	-41.952	11.047	-45.574	17.726
-9.643	-17.899	-24.497	-8.374	-38.297	1.399	-41.937	11.041	-46.063	17.726
-9.669	-17.896	-24.486	-8.365	-38.303	1.402	-41.9	11.051	-46.112	17.75
-9.705	-17.883	-24.407	-8.339	-38.283	1.423	-41.882	11.043	-45.573	17.759
-9.693	-17.862	-24.275	-8.34	-38.249	1.435	-41.856	11.044	-45.948	17.77
-9.759	-17.861	-24.187	-8.317	-38.27	1.441	-41.819	11.052	-45.928	17.788
-9.797	-17.843	-24.171	-8.301	-38.268	1.466	-41.804	11.04	-45.844	17.788
-9.816	-17.832	-24.181	-8.299	-38.292	1.468	-41.788	11.049	-46.132	17.812
-9.825	-17.824	-24.152	-8.274	-38.302	1.482	-41.761	11.05	-45.718	17.823
-9.818	-17.8	-24.166	-8.271	-38.28	1.503	-41.74	11.046	-46.032	17.831
-9.852	-17.798	-24.195	-8.255	-38.307	1.504	-41.735	11.047	-45.979	17.853
-9.9	-17.783	-24.214	-8.234	-38.24	1.529	-41.713	11.047	-45.81	17.858
-9.908	-17.765	-24.225	-8.237	-38.146	1.536	-41.699	11.047	-46.128	17.874
-9.963	-17.768	-24.252	-8.213	-38.141	1.546	-41.682	11.048	-45.64	17.888
-10.001	-17.745	-24.254	-8.206	-38.113	1.564	-41.666	11.047	-45.942	17.893
-10.019	-17.734	-24.297	-8.2	-38.118	1.566	-41.646	11.048	-45.909	17.922
-10.104	-17.725	-24.3	-8.175	-38.119	1.588	-41.633	11.047	-45.895	17.924
-10.094	-17.703	-24.333	-8.176	-38.101	1.601	-41.617	11.048	-46.109	17.934
-10.131	-17.7	-24.349	-8.152	-38.097	1.604	-41.606	11.048	-45.637	17.957
-10.184	-17.682	-24.337	-8.141	-38.056	1.634	-41.59	11.047	-45.889	17.956
-10.127	-17.668	-24.402	-8.141	-38.068	1.632	-41.577	11.047	-45.945	17.976
-10.204	-17.667	-24.41	-8.11	-38.104	1.648	-41.571	11.048	-45.611	17.986
-10.202	-17.642	-24.426	-8.106	-38.113	1.663	-41.564	11.049	-45.941	17.996
-10.242	-17.636	-24.447	-8.097	-38.128	1.671	-41.546	11.047	-45.906	18.021
-10.294	-17.627	-24.436	-8.075	-38.118	1.694	-41.529	11.047	-45.594	18.019
-10.276	-17.605	-24.458	-8.076	-38.097	1.697	-41.524	11.048	-45.835	18.041

Annex A

-10.309	-17.603	-24.466	-8.048	-38.117	1.709	-41.508	11.055	-45.661	18.055
-10.33	-17.582	-24.479	-8.043	-38.112	1.732	-41.496	11.041	-45.555	18.061
-10.322	-17.571	-24.533	-8.037	-38.139	1.731	-41.484	11.051	-45.787	18.08
-10.343	-17.568	-24.532	-8.005	-38.169	1.754	-41.478	11.048	-45.73	18.087
-10.363	-17.545	-24.556	-8.011	-38.189	1.764	-41.469	11.045	-45.642	18.107
-10.398	-17.544	-24.556	-7.986	-38.235	1.771	-41.45	11.053	-45.767	18.122
-10.418	-17.529	-24.541	-7.977	-38.265	1.794	-41.454	11.043	-45.532	18.125
-10.429	-17.508	-24.562	-7.97	-38.324	1.795	-41.438	11.054	-45.815	18.144
-10.444	-17.508	-24.547	-7.945	-38.37	1.814	-41.431	11.048	-45.857	18.152
-10.444	-17.486	-24.58	-7.941	-38.403	1.828	-41.423	11.047	-45.492	18.171
-10.429	-17.482	-24.615	-7.93	-38.423	1.833	-41.405	11.05	-45.86	18.185
-10.468	-17.471	-24.599	-7.908	-38.479	1.858	-41.399	11.049	-46	18.187
-10.48	-17.444	-24.628	-7.91	-38.572	1.862	-41.391	11.049	-45.313	18.212
-10.564	-17.446	-24.624	-7.884	-38.682	1.872	-41.386	11.049	-45.864	18.221
-10.577	-17.427	-24.629	-7.876	-38.725	1.892	-41.373	11.049	-46.027	18.225
-10.591	-17.412	-24.689	-7.867	-38.769	1.896	-41.372	11.046	-45.27	18.252
-10.642	-17.408	-24.758	-7.845	-38.809	1.917	-41.357	11.054	-45.719	18.255
-10.649	-17.387	-24.798	-7.844	-38.85	1.923	-41.354	11.045	-45.23	18.271
-10.662	-17.382	-24.811	-7.82	-38.875	1.932	-41.348	11.049	-45.519	18.287
-10.698	-17.369	-24.803	-7.814	-38.867	1.956	-41.322	11.053	-45.316	18.293
-10.683	-17.351	-24.831	-7.811	-38.907	1.956	-41.338	11.045	-45.507	18.315
-10.726	-17.35	-24.833	-7.783	-38.914	1.972	-41.321	11.053	-45.454	18.322
-10.74	-17.326	-24.881	-7.78	-38.928	1.989	-41.32	11.049	-45.19	18.334
-10.761	-17.317	-24.905	-7.769	-38.966	1.994	-41.326	11.047	-45.355	18.353
-10.783	-17.312	-24.908	-7.748	-38.977	2.016	-41.303	11.052	-45.661	18.352
-10.822	-17.288	-24.945	-7.747	-38.961	2.021	-41.304	11.048	-44.817	18.38
-10.856	-17.289	-24.955	-7.722	-38.965	2.036	-41.299	11.049	-45.372	18.384
-10.874	-17.271	-24.991	-7.716	-38.943	2.057	-41.291	11.049	-45.134	18.395
-10.856	-17.253	-25.042	-7.713	-38.95	2.053	-41.285	11.05	-45.203	18.414
-10.874	-17.254	-25.063	-7.683	-38.974	2.077	-41.279	11.049	-45.061	18.422
-10.874	-17.229	-25.1	-7.685	-39.013	2.087	-41.272	11.051	-45.165	18.437
-10.857	-17.22	-25.107	-7.667	-39.065	2.096	-41.267	11.049	-45.36	18.451
-10.868	-17.215	-25.101	-7.651	-39.041	2.121	-41.263	11.048	-44.833	18.457
-10.863	-17.192	-25.134	-7.649	-39.033	2.12	-41.254	11.054	-45.376	18.481
-10.898	-17.191	-25.132	-7.62	-39.005	2.145	-41.249	11.048	-45.124	18.486
-10.917	-17.173	-25.168	-7.624	-38.976	2.154	-41.242	11.046	-45.211	18.495
-10.911	-17.161	-25.219	-7.607	-39.006	2.157	-41.236	11.056	-44.902	18.52
-10.933	-17.154	-25.215	-7.583	-39.014	2.186	-41.226	11.047	-45.434	18.519
-10.934	-17.133	-25.235	-7.589	-38.989	2.188	-41.22	11.05	-45.485	18.543
-10.946	-17.129	-25.225	-7.56	-38.979	2.205	-41.22	11.054	-44.822	18.553
-10.965	-17.116	-25.222	-7.555	-38.952	2.219	-41.212	11.044	-45.3	18.559

Annex A

-10.935	-17.094	-25.255	-7.545	-38.963	2.225	-41.205	11.055	-45.202	18.584
-10.958	-17.095	-25.266	-7.521	-38.937	2.25	-41.191	11.05	-45.031	18.586
-10.955	-17.074	-25.314	-7.523	-38.877	2.255	-41.198	11.044	-45.21	18.605
-10.934	-17.064	-25.36	-7.501	-38.837	2.266	-41.179	11.057	-45.094	18.617
-10.954	-17.055	-25.372	-7.487	-38.785	2.289	-41.187	11.046	-45.42	18.622
-10.903	-17.033	-25.417	-7.486	-38.804	2.29	-41.182	11.049	-44.756	18.648
-10.859	-17.031	-25.437	-7.459	-38.804	2.31	-41.166	11.055	-45.383	18.65
-10.857	-17.013	-25.434	-7.457	-38.833	2.324	-41.181	11.043	-45.138	18.663
-10.839	-16.994	-25.479	-7.443	-38.86	2.329	-41.163	11.056	-45.451	18.679
-10.841	-16.996	-25.499	-7.422	-38.874	2.349	-41.152	11.052	-44.922	18.691
-10.83	-16.975	-25.535	-7.427	-38.917	2.354	-41.159	11.044	-45.496	18.706
-10.839	-16.963	-25.555	-7.402	-38.953	2.371	-41.142	11.053	-45.217	18.718
-10.873	-16.953	-25.552	-7.393	-38.961	2.387	-41.133	11.052	-45.293	18.725
-10.861	-16.933	-25.622	-7.388	-38.96	2.389	-41.14	11.049	-45.105	18.747
-10.89	-16.933	-25.625	-7.357	-38.952	2.413	-41.132	11.05	-45.333	18.747
-10.896	-16.907	-25.688	-7.365	-38.995	2.423	-41.127	11.05	-45.188	18.769
-10.888	-16.896	-25.734	-7.345	-39.072	2.431	-41.116	11.051	-45.325	18.777
-10.929	-16.894	-25.734	-7.323	-39.139	2.451	-41.121	11.05	-45.405	18.786
-10.928	-16.87	-25.761	-7.327	-39.146	2.455	-41.112	11.052	-45.306	18.808
-10.945	-16.866	-25.729	-7.299	-39.125	2.475	-41.097	11.049	-45.623	18.811
-10.968	-16.852	-25.751	-7.301	-39.096	2.488	-41.099	11.051	-45.016	18.827
-10.979	-16.833	-25.77	-7.282	-39.108	2.494	-41.102	11.052	-45.61	18.843
-11.006	-16.831	-25.77	-7.261	-39.114	2.517	-41.096	11.05	-45.172	18.852
-10.997	-16.812	-25.83	-7.264	-39.173	2.522	-41.089	11.05	-45.492	18.869
-10.998	-16.803	-25.819	-7.236	-39.223	2.535	-41.081	11.052	-45.236	18.88
-11.005	-16.8	-25.803	-7.225	-39.268	2.548	-41.084	11.052	-45.549	18.889
-10.997	-16.774	-25.802	-7.219	-39.301	2.554	-41.079	11.052	-45.545	18.912
-11.026	-16.773	-25.799	-7.196	-39.32	2.58	-41.072	11.049	-45.348	18.914
-11.068	-16.757	-25.823	-7.196	-39.331	2.583	-41.072	11.05	-45.519	18.933
-11.088	-16.741	-25.852	-7.178	-39.332	2.599	-41.065	11.052	-45.725	18.94
-11.128	-16.737	-25.845	-7.162	-39.324	2.615	-41.062	11.05	-45.94	18.948
-11.104	-16.716	-25.874	-7.161	-39.351	2.62	-41.055	11.048	-45.137	18.977
-11.094	-16.71	-25.852	-7.128	-39.393	2.641	-41.057	11.053	-45.813	18.976
-11.131	-16.698	-25.827	-7.13	-39.441	2.65	-41.05	11.053	-46.065	18.991
-11.117	-16.678	-25.834	-7.114	-39.459	2.662	-41.053	11.05	-45.382	19.01
-11.15	-16.677	-25.823	-7.093	-39.445	2.682	-41.044	11.05	-45.67	19.014
-11.146	-16.655	-25.859	-7.095	-39.464	2.68	-41.038	11.05	-45.992	19.032
-11.154	-16.643	-25.859	-7.072	-39.467	2.701	-41.032	11.053	-45.884	19.037
-11.152	-16.641	-25.845	-7.06	-39.466	2.715	-41.026	11.051	-45.482	19.06
-11.156	-16.616	-25.864	-7.055	-39.502	2.719	-41.015	11.048	-45.953	19.071
-11.16	-16.615	-25.845	-7.032	-39.497	2.742	-41.011	11.051	-46.122	19.075

Annex A

-11.172	-16.597	-25.885	-7.031	-39.489	2.745	-41.017	11.052	-45.405	19.099
-11.181	-16.578	-25.914	-7.014	-39.488	2.761	-41	11.051	-45.926	19.105
-11.203	-16.578	-25.962	-6.995	-39.515	2.772	-41.003	11.051	-46.075	19.113
-11.208	-16.554	-25.989	-6.995	-39.546	2.781	-40.996	11.05	-45.842	19.132
-11.224	-16.547	-26.008	-6.967	-39.582	2.802	-40.99	11.055	-45.703	19.138
-11.249	-16.539	-26.032	-6.965	-39.616	2.812	-40.982	11.047	-46.122	19.15
-11.26	-16.52	-26.076	-6.95	-39.694	2.817	-40.998	11.054	-46.168	19.165
-11.292	-16.513	-26.077	-6.932	-39.721	2.842	-40.976	11.052	-45.429	19.178
-11.318	-16.495	-26.135	-6.934	-39.773	2.843	-40.986	11.046	-45.935	19.194
-11.317	-16.48	-26.178	-6.909	-39.81	2.859	-40.97	11.058	-45.805	19.202
-11.375	-16.483	-26.208	-6.9	-39.825	2.874	-40.97	11.047	-45.602	19.218
-11.361	-16.456	-26.256	-6.893	-39.908	2.88	-40.978	11.052	-45.764	19.236
-11.403	-16.451	-26.257	-6.87	-39.914	2.905	-40.959	11.054	-45.621	19.238
-11.445	-16.44	-26.292	-6.871	-39.918	2.907	-40.982	11.047	-45.996	19.258
-11.463	-16.417	-26.302	-6.849	-39.939	2.923	-40.963	11.059	-45.248	19.276
-11.518	-16.418	-26.308	-6.835	-39.932	2.944	-40.955	11.047	-45.897	19.281
-11.521	-16.396	-26.358	-6.837	-39.933	2.944	-40.956	11.049	-45.505	19.298
-11.528	-16.386	-26.389	-6.807	-39.94	2.964	-40.945	11.057	-45.731	19.302
-11.567	-16.382	-26.429	-6.806	-39.95	2.973	-40.952	11.046	-45.45	19.326
-11.539	-16.359	-26.466	-6.794	-39.948	2.984	-40.947	11.055	-45.637	19.337
-11.582	-16.357	-26.482	-6.772	-39.933	3.009	-40.935	11.052	-45.717	19.34
-11.591	-16.34	-26.539	-6.775	-39.95	3.009	-40.949	11.048	-45.425	19.364
-11.605	-16.324	-26.565	-6.743	-39.952	3.028	-40.932	11.059	-45.688	19.372
-11.661	-16.322	-26.619	-6.739	-39.976	3.04	-40.92	11.046	-45.391	19.388
-11.66	-16.297	-26.678	-6.734	-40.012	3.048	-40.924	11.052	-45.808	19.399
-11.645	-16.293	-26.674	-6.707	-40.04	3.068	-40.912	11.056	-45.164	19.408
-11.678	-16.283	-26.685	-6.708	-40.066	3.072	-40.924	11.046	-45.795	19.429
-11.659	-16.261	-26.738	-6.685	-40.064	3.09	-40.918	11.056	-45.543	19.437
-11.682	-16.263	-26.778	-6.675	-40.048	3.105	-40.925	11.048	-45.744	19.446
-11.675	-16.24	-26.825	-6.673	-40.069	3.107	-40.916	11.051	-45.39	19.472
-11.687	-16.223	-26.896	-6.648	-40.064	3.124	-40.907	11.059	-45.765	19.469
-11.695	-16.224	-26.938	-6.647	-40.07	3.132	-40.894	11.045	-45.716	19.49
-11.661	-16.199	-27.01	-6.632	-40.057	3.147	-40.906	11.055	-45.584	19.501
-11.641	-16.194	-27.018	-6.613	-40.033	3.167	-40.885	11.054	-45.782	19.51
-11.659	-16.18	-27.075	-6.615	-40.052	3.168	-40.894	11.046	-45.359	19.529
-11.658	-16.159	-27.102	-6.59	-40.017	3.189	-40.879	11.059	-45.862	19.533
-11.706	-16.163	-27.137	-6.582	-40.022	3.198	-40.878	11.047	-45.338	19.552
-11.723	-16.135	-27.176	-6.573	-40.036	3.211	-40.891	11.053	-45.56	19.565
-11.758	-16.128	-27.199	-6.551	-40.014	3.227	-40.882	11.056	-45.381	19.573
-11.736	-16.12	-27.225	-6.55	-39.974	3.233	-40.89	11.045	-45.608	19.59
-11.769	-16.102	-27.232	-6.528	-39.95	3.252	-40.88	11.058	-45.826	19.601

Annex A

-11.781	-16.098	-27.248	-6.518	-39.915	3.267	-40.848	11.052	-45.198	19.613
-11.79	-16.08	-27.31	-6.516	-39.894	3.272	-40.875	11.048	-45.671	19.632
-11.811	-16.067	-27.359	-6.485	-39.858	3.293	-40.852	11.058	-45.37	19.637
-11.845	-16.061	-27.403	-6.485	-39.821	3.303	-40.856	11.046	-45.459	19.658
-11.846	-16.036	-27.455	-6.472	-39.817	3.313	-40.857	11.053	-45.487	19.669
-11.875	-16.032	-27.466	-6.454	-39.799	3.334	-40.843	11.056	-45.309	19.678
-11.913	-16.022	-27.53	-6.449	-39.801	3.334	-40.856	11.046	-45.647	19.696
-11.912	-16.006	-27.533	-6.426	-39.755	3.359	-40.84	11.058	-45.279	19.706
-11.967	-16.002	-27.562	-6.424	-39.707	3.371	-40.838	11.048	-45.617	19.715
-11.934	-15.984	-27.611	-6.413	-39.697	3.374	-40.85	11.051	-45.397	19.737
-11.924	-15.971	-27.626	-6.39	-39.656	3.402	-40.83	11.059	-45.368	19.742
-11.921	-15.968	-27.685	-6.391	-39.644	3.404	-40.837	11.046	-45.57	19.763
-11.899	-15.94	-27.712	-6.367	-39.623	3.422	-40.833	11.055	-45.509	19.769
-11.923	-15.941	-27.711	-6.352	-39.618	3.435	-40.824	11.054	-45.785	19.779
-11.96	-15.923	-27.744	-6.35	-39.605	3.441	-40.829	11.05	-45.265	19.803
-11.989	-15.905	-27.757	-6.326	-39.599	3.466	-40.811	11.058	-45.731	19.805
-12.031	-15.91	-27.787	-6.329	-39.59	3.472	-40.823	11.046	-45.722	19.825
-12.017	-15.88	-27.834	-6.308	-39.618	3.482	-40.83	11.054	-45.48	19.838
-12.049	-15.877	-27.85	-6.289	-39.573	3.5	-40.808	11.057	-45.777	19.845
-12.071	-15.867	-27.885	-6.288	-39.564	3.501	-40.817	11.045	-45.44	19.867
-12.095	-15.845	-27.924	-6.264	-39.582	3.524	-40.801	11.057	-45.761	19.869
-12.116	-15.844	-27.952	-6.259	-39.538	3.531	-40.805	11.052	-45.639	19.888
-12.169	-15.824	-28.025	-6.252	-39.539	3.544	-40.805	11.05	-45.637	19.901
-12.172	-15.81	-28.035	-6.23	-39.543	3.563	-40.8	11.058	-45.753	19.906
-12.208	-15.808	-28.066	-6.233	-39.574	3.57	-40.819	11.045	-45.587	19.922
-12.197	-15.78	-28.078	-6.21	-39.591	3.585	-40.805	11.057	-45.998	19.929
-12.153	-15.778	-28.044	-6.198	-39.581	3.599	-40.788	11.055	-45.602	19.948
-12.121	-15.767	-28.086	-6.192	-39.582	3.604	-40.799	11.046	-45.868	19.96
-12.12	-15.748	-28.092	-6.168	-39.56	3.627	-40.794	11.058	-45.6	19.968
-12.122	-15.743	-28.128	-6.163	-39.544	3.632	-40.784	11.049	-45.801	19.987
-12.144	-15.722	-28.175	-6.153	-39.546	3.648	-40.789	11.052	-45.85	19.995
-12.143	-15.71	-28.175	-6.136	-39.519	3.664	-40.776	11.056	-45.62	20.008
-12.192	-15.705	-28.218	-6.131	-39.536	3.669	-40.787	11.046	-45.906	20.026
-12.21	-15.678	-28.214	-6.108	-39.534	3.688	-40.763	11.058	-45.443	20.033
-12.271	-15.678	-28.23	-6.102	-39.537	3.701	-40.772	11.052	-45.954	20.047
-12.293	-15.664	-28.243	-6.091	-39.553	3.708	-40.777	11.048	-45.577	20.065
-12.324	-15.648	-28.228	-6.067	-39.558	3.73	-40.756	11.06	-45.767	20.073
-12.393	-15.648	-28.266	-6.071	-39.589	3.735	-40.771	11.047	-45.515	20.094
-12.368	-15.623	-28.295	-6.05	-39.586	3.751	-40.768	11.055	-45.683	20.098
-12.305	-15.623	-28.296	-6.037	-39.586	3.762	-40.758	11.056	-45.754	20.112
-12.319	-15.609	-28.328	-6.028	-39.617	3.772	-40.765	11.046	-45.433	20.132

Annex A

-12.334	-15.589	-28.317	-6.004	-39.591	3.795	-40.752	11.058	-45.833	20.132
-12.352	-15.586	-28.353	-6.006	-39.601	3.8	-40.751	11.05	-45.618	20.153
-12.381	-15.569	-28.393	-5.988	-39.62	3.814	-40.761	11.052	-45.918	20.162
-12.432	-15.557	-28.437	-5.969	-39.606	3.83	-40.736	11.058	-45.268	20.175
-12.494	-15.55	-28.482	-5.971	-39.636	3.835	-40.754	11.045	-45.792	20.192
-12.536	-15.527	-28.501	-5.945	-39.648	3.856	-40.755	11.058	-45.531	20.2
-12.552	-15.526	-28.535	-5.939	-39.652	3.865	-40.733	11.055	-45.689	20.218
-12.562	-15.511	-28.552	-5.924	-39.678	3.875	-40.751	11.047	-45.612	20.233
-12.572	-15.495	-28.395	-5.906	-39.669	3.896	-40.727	11.059	-45.668	20.234
-12.61	-15.493	-28.305	-5.904	-39.727	3.898	-40.731	11.048	-45.726	20.256
-12.631	-15.469	-28.337	-5.881	-39.777	3.915	-40.721	11.054	-45.368	20.267
-12.629	-15.461	-28.38	-5.87	-39.732	3.929	-40.71	11.056	-45.676	20.28
-12.654	-15.451	-28.423	-5.87	-39.736	3.934	-40.735	11.044	-45.262	20.296
-12.667	-15.431	-28.421	-5.843	-39.708	3.959	-40.719	11.059	-45.771	20.297
-12.714	-15.43	-28.401	-5.839	-39.719	3.961	-40.725	11.054	-45.206	20.318
-12.729	-15.412	-28.455	-5.823	-39.735	3.979	-40.728	11.049	-45.772	20.322
-12.754	-15.398	-28.5	-5.812	-39.707	3.996	-40.697	11.058	-45.127	20.338
-12.822	-15.396	-28.567	-5.807	-39.766	3.997	-40.711	11.048	-45.735	20.354
-12.829	-15.369	-28.597	-5.782	-39.747	4.021	-40.715	11.056	-45.049	20.363
-12.838	-15.366	-28.592	-5.774	-39.771	4.029	-40.7	11.055	-45.743	20.378
-12.878	-15.356	-28.622	-5.767	-39.833	4.041	-40.718	11.046	-45.369	20.393
-12.901	-15.333	-28.61	-5.743	-39.889	4.057	-40.686	11.06	-45.665	20.398
-12.925	-15.333	-28.628	-5.746	-39.939	4.063	-40.689	11.05	-45.132	20.422
-12.951	-15.312	-28.647	-5.721	-39.975	4.082	-40.706	11.053	-45.708	20.425
-12.971	-15.304	-28.67	-5.709	-40.026	4.091	-40.688	11.058	-45.345	20.444
-12.998	-15.297	-28.7	-5.706	-40.09	4.101	-40.698	11.047	-45.594	20.455
-12.962	-15.267	-28.684	-5.681	-40.137	4.123	-40.668	11.057	-45.271	20.464
-12.97	-15.272	-28.7	-5.678	-40.202	4.124	-40.685	11.053	-45.697	20.483
-12.957	-15.253	-28.688	-5.659	-40.232	4.141	-40.681	11.049	-45.782	20.493
-12.966	-15.24	-28.668	-5.643	-40.225	4.158	-40.667	11.06	-45.371	20.503
-12.979	-15.238	-28.673	-5.642	-40.269	4.162	-40.67	11.049	-45.457	20.524
-13	-15.212	-28.68	-5.615	-40.285	4.182	-40.68	11.055	-45.682	20.527
-13.001	-15.211	-28.696	-5.609	-40.319	4.19	-40.666	11.057	-45.778	20.547
-13.013	-15.2	-28.719	-5.595	-40.357	4.203	-40.674	11.047	-45.312	20.558
-12.984	-15.173	-28.734	-5.578	-40.385	4.222	-40.66	11.059	-45.722	20.567
-12.983	-15.177	-28.764	-5.575	-40.402	4.225	-40.666	11.052	-45.964	20.585
-12.968	-15.155	-28.804	-5.55	-40.417	4.248	-40.675	11.051	-46.165	20.588
-12.947	-15.143	-28.83	-5.544	-40.478	4.256	-40.643	11.059	-45.208	20.61
-12.982	-15.139	-28.908	-5.539	-40.505	4.264	-40.658	11.047	-45.906	20.619
-12.968	-15.114	-28.934	-5.513	-40.498	4.285	-40.644	11.057	-45.415	20.631
-12.945	-15.112	-28.983	-5.512	-40.56	4.285	-40.639	11.055	-45.707	20.649

Annex A

-12.965	-15.094	-29.011	-5.494	-40.569	4.304	-40.649	11.047	-45.372	20.661
-12.945	-15.077	-29.026	-5.478	-40.579	4.317	-40.647	11.061	-45.953	20.668
-12.964	-15.074	-29.082	-5.482	-40.611	4.32	-40.657	11.051	-45.477	20.688
-12.959	-15.051	-29.096	-5.452	-40.635	4.344	-40.649	11.053	-45.886	20.688
-12.945	-15.044	-29.104	-5.451	-40.684	4.351	-40.632	11.057	-45.253	20.712
-12.958	-15.036	-29.139	-5.437	-40.628	4.364	-40.65	11.047	-45.88	20.716
-12.938	-15.012	-29.162	-5.419	-40.645	4.381	-40.637	11.06	-45.236	20.733
-12.963	-15.012	-29.208	-5.413	-40.677	4.386	-40.631	11.053	-45.934	20.751
-12.977	-14.993	-29.23	-5.393	-40.704	4.408	-40.644	11.049	-45.412	20.758
-12.968	-14.976	-29.257	-5.386	-40.631	4.414	-40.651	11.059	-45.953	20.77
-12.98	-14.975	-29.294	-5.376	-40.644	4.429	-41.762	11.054	-45.065	20.789
-12.939	-14.947	-29.312	-5.354	-40.651	4.445	-43.097	11.056	-45.823	20.79
-12.916	-14.944	-29.356	-5.351	-40.641	4.448	-43.229	11.067	-45.294	20.815
-12.91	-14.935	-29.397	-5.336	-40.647	4.47	-40.64	11.104	-45.983	20.82
-12.861	-14.912	-29.396	-5.317	-40.634	4.482	-41.612	11.12	-45.458	20.835
-12.868	-14.912	-29.418	-5.315	-40.648	4.488	-42.494	11.121	-46.081	20.849
-12.855	-14.888	-29.444	-5.291	-40.642	4.513	-43.061	11.119	-45.304	20.861
-12.821	-14.881	-29.481	-5.286	-40.649	4.514	-43.1	11.14	-45.963	20.876
-12.844	-14.869	-29.554	-5.276	-40.705	4.534	-42.444	11.155	-45.663	20.884
-12.822	-14.844	-29.568	-5.256	-40.715	4.549	-43.022	11.166	-46.118	20.893
-12.83	-14.849	-29.626	-5.252	-40.768	4.552	-42.948	11.183	-45.495	20.918
-12.842	-14.83	-29.65	-5.231	-40.796	4.574	-42.73	11.187	-46.112	20.921
-12.831	-14.812	-29.671	-5.223	-40.819	4.585	-42.766	11.21	-45.407	20.937
-12.869	-14.812	-29.682	-5.218	-40.855	4.591	-42.992	11.215	-46.047	20.948
-12.872	-14.789	-29.683	-5.189	-40.883	4.61	-43.153	11.227	-45.591	20.96
-12.879	-14.784	-29.7	-5.187	-40.909	4.617	-42.628	11.25	-46.065	20.976
-12.906	-14.77	-29.729	-5.171	-40.94	4.635	-43.171	11.248	-45.447	20.987
-12.908	-14.748	-29.748	-5.155	-40.951	4.647	-43.223	11.271	-46.098	20.996
-12.931	-14.752	-29.773	-5.151	-40.994	4.653	-42.881	11.283	-45.585	21.02
-12.935	-14.728	-29.763	-5.124	-40.995	4.677	-43.226	11.288	-46.039	21.018
-12.931	-14.717	-29.804	-5.122	-40.936	4.68	-43.421	11.309	-45.441	21.045
-12.955	-14.714	-29.829	-5.11	-40.917	4.692	-43.212	11.312	-46.088	21.051
-12.929	-14.688	-29.853	-5.091	-40.896	4.711	-43.16	11.327	-45.353	21.065
-12.962	-14.687	-29.906	-5.089	-40.959	4.716	-43.47	11.342	-46.071	21.079
-12.979	-14.665	-29.9	-5.068	-40.978	4.736	-43.155	11.347	-45.447	21.085
-12.955	-14.652	-29.907	-5.059	-41.027	4.745	-43.135	11.373	-46.078	21.099
-12.991	-14.655	-29.929	-5.051	-41.081	4.754	-43.442	11.38	-45.41	21.117
-12.999	-14.628	-29.938	-5.028	-41.078	4.777	-43.309	11.386	-46.091	21.12
-13.003	-14.621	-29.977	-5.031	-41.128	4.779	-43.098	11.409	-45.317	21.145
-13.029	-14.611	-30.018	-5.006	-41.171	4.796	-43.452	11.412	-45.95	21.147
-13.047	-14.59	-30.031	-4.995	-41.215	4.808	-43.376	11.432	-45.409	21.165

Annex A

-13.104	-14.59	-30.075	-4.987	-41.271	4.817	-43.187	11.446	-45.982	21.179
-13.142	-14.565	-30.091	-4.966	-41.282	4.841	-43.635	11.448	-45.581	21.187
-13.182	-14.556	-30.066	-4.958	-41.303	4.843	-43.594	11.473	-45.964	21.202
-13.236	-14.555	-30.144	-4.945	-41.319	4.861	-43.551	11.471	-45.49	21.217
-13.244	-14.528	-30.185	-4.927	-41.329	4.877	-43.557	11.486	-45.939	21.223
-13.267	-14.526	-30.234	-4.924	-41.355	4.879	-43.555	11.503	-45.419	21.247
-13.291	-14.512	-30.233	-4.902	-41.359	4.902	-43.644	11.509	-45.861	21.248
-13.308	-14.493	-30.245	-4.895	-41.377	4.909	-43.593	11.528	-45.503	21.271
-13.351	-14.494	-30.255	-4.885	-41.389	4.922	-43.65	11.534	-45.727	21.281
-13.395	-14.467	-30.274	-4.861	-41.395	4.939	-43.682	11.544	-45.564	21.291
-13.45	-14.462	-30.311	-4.861	-41.433	4.945	-43.915	11.566	-45.769	21.308
-13.507	-14.455	-30.342	-4.84	-41.438	4.966	-43.839	11.568	-45.524	21.321
-13.555	-14.434	-30.359	-4.831	-41.448	4.976	-43.935	11.585	-45.683	21.329
-13.588	-14.436	-30.417	-4.823	-41.414	4.982	-44.034	11.598	-45.584	21.35
-13.657	-14.411	-30.415	-4.798	-41.297	5.007	-43.793	11.607	-45.696	21.351
-13.684	-14.402	-30.4	-4.795	-41.289	5.012	-43.944	11.628	-45.692	21.373
-13.734	-14.397	-30.44	-4.782	-41.282	5.027	-43.98	11.633	-45.555	21.383
-13.747	-14.376	-30.467	-4.759	-41.26	5.044	-43.788	11.649	-45.722	21.395
-13.777	-14.373	-30.528	-4.76	-41.263	5.05	-43.953	11.664	-45.478	21.411
-13.818	-14.354	-30.561	-4.738	-41.26	5.068	-44.19	11.669	-45.682	21.417
-13.82	-14.34	-30.589	-4.73	-41.251	5.072	-43.822	11.689	-45.571	21.434
-13.873	-14.338	-30.64	-4.719	-41.277	5.087	-44.094	11.698	-45.826	21.447
-13.883	-14.315	-30.606	-4.696	-41.266	5.108	-44.276	11.704	-45.339	21.456
-13.916	-14.307	-30.63	-4.703	-41.255	5.108	-43.831	11.729	-45.711	21.475
-13.966	-14.298	-30.669	-4.682	-41.234	5.128	-44.106	11.728	-45.616	21.479
-13.95	-14.276	-30.674	-4.67	-41.205	5.142	-44.266	11.744	-45.885	21.492
-13.983	-14.274	-30.724	-4.667	-41.202	5.15	-43.983	11.758	-45.525	21.506
-14.031	-14.254	-30.74	-4.643	-41.192	5.17	-44.347	11.761	-45.919	21.513
-14.065	-14.242	-30.79	-4.639	-41.179	5.173	-44.318	11.784	-45.669	21.535
-14.099	-14.24	-30.819	-4.623	-41.166	5.194	-44.209	11.792	-46.056	21.542
-14.12	-14.213	-30.824	-4.608	-41.123	5.209	-44.442	11.801	-45.683	21.554
-14.15	-14.21	-30.877	-4.606	-41.099	5.21	-44.272	11.823	-46.135	21.572
-14.189	-14.198	-30.916	-4.582	-41.062	5.237	-44.445	11.826	-45.63	21.578
-14.187	-14.175	-30.973	-4.576	-41.043	5.243	-44.552	11.847	-46.199	21.597
-14.241	-14.177	-31.015	-4.564	-41.013	5.257	-44.217	11.856	-45.886	21.606
-14.25	-14.152	-31.055	-4.543	-40.975	5.277	-44.451	11.865	-46.304	21.614
-14.239	-14.147	-31.077	-4.54	-40.984	5.278	-44.5	11.888	-45.442	21.642
-14.254	-14.138	-31.076	-4.519	-40.944	5.301	-44.363	11.892	-46.18	21.64
-14.273	-14.114	-31.109	-4.509	-40.908	5.311	-44.367	11.906	-45.855	21.659
-14.293	-14.115	-31.18	-4.507	-40.945	5.321	-44.47	11.922	-46.311	21.671
-14.303	-14.094	-31.24	-4.482	-40.961	5.343	-44.537	11.926	-45.471	21.681

Annex A

-14.275	-14.077	-31.294	-4.477	-40.96	5.344	-44.445	11.949	-46.14	21.698
-14.315	-14.079	-31.308	-4.465	-40.967	5.363	-44.529	11.954	-45.824	21.707
-14.313	-14.052	-31.303	-4.445	-40.966	5.378	-44.456	11.969	-46.266	21.717
-14.336	-14.052	-31.314	-4.444	-40.971	5.381	-44.522	11.988	-45.636	21.739
-14.361	-14.04	-31.319	-4.418	-40.959	5.407	-44.609	11.991	-46.225	21.741
-14.384	-14.019	-31.354	-4.411	-40.992	5.409	-44.35	12.012	-45.528	21.766
-14.443	-14.021	-31.39	-4.403	-41.014	5.426	-44.509	12.021	-46.158	21.77
-14.452	-13.995	-31.413	-4.381	-41.036	5.445	-44.482	12.028	-45.65	21.781
-14.456	-13.987	-31.438	-4.381	-41.043	5.445	-44.537	12.051	-46.147	21.801
-14.49	-13.983	-31.437	-4.357	-41.052	5.467	-44.53	12.055	-45.657	21.809
-14.496	-13.96	-31.413	-4.346	-41.039	5.476	-44.115	12.071	-46.03	21.824
-14.498	-13.956	-31.414	-4.341	-41.064	5.484	-44.495	12.09	-45.885	21.834
-14.513	-13.936	-31.402	-4.319	-41.087	5.503	-44.454	12.09	-45.985	21.843
-14.517	-13.926	-31.435	-4.315	-41.124	5.506	-44.331	12.113	-46.038	21.86
-14.553	-13.922	-31.464	-4.297	-41.163	5.526	-44.54	12.116	-45.908	21.867
-14.551	-13.894	-31.439	-4.285	-41.144	5.542	-44.171	12.131	-46.221	21.875
-14.537	-13.891	-31.433	-4.28	-41.172	5.543	-44.35	12.151	-45.977	21.898
-14.564	-13.88	-31.392	-4.255	-41.154	5.567	-44.454	12.153	-45.913	21.9
-14.558	-13.861	-31.38	-4.252	-41.147	5.575	-44.222	12.171	-45.804	21.922
-14.57	-13.858	-31.392	-4.241	-41.174	5.588	-44.297	12.184	-45.955	21.929
-14.597	-13.838	-31.411	-4.221	-41.163	5.607	-44.318	12.193	-45.827	21.942
-14.602	-13.826	-31.419	-4.216	-41.2	5.608	-44.345	12.215	-45.803	21.962
-14.673	-13.823	-31.39	-4.197	-41.198	5.631	-44.319	12.217	-45.691	21.967
-14.723	-13.792	-31.339	-4.184	-41.204	5.637	-44.178	12.236	-45.978	21.98
-14.779	-13.796	-31.308	-4.178	-41.209	5.648	-44.404	12.251	-45.605	22.001
-14.813	-13.781	-31.271	-4.152	-41.191	5.671	-44.437	12.253	-45.975	22.001
-14.801	-13.764	-31.237	-4.148	-41.208	5.673	-44.185	12.278	-45.594	22.03
-14.844	-13.763	-31.218	-4.132	-41.191	5.69	-44.386	12.282	-45.846	22.028
-14.87	-13.735	-31.193	-4.119	-41.184	5.701	-44.254	12.297	-45.552	22.048
-14.895	-13.729	-31.172	-4.106	-41.206	5.709	-44.294	12.315	-45.819	22.063
-14.938	-13.719	-31.085	-4.085	-41.187	5.736	-44.36	12.317	-45.571	22.071
-14.949	-13.699	-31.043	-4.082	-41.195	5.737	-44.023	12.341	-45.795	22.088
-14.987	-13.703	-31.037	-4.066	-41.202	5.756	-44.239	12.351	-45.507	22.1
-15.03	-13.68	-31.032	-4.044	-41.184	5.772	-44.296	12.359	-45.933	22.104
-15.012	-13.673	-31.015	-4.041	-41.185	5.774	-44.152	12.378	-45.41	22.131
-15.069	-13.664	-30.988	-4.022	-41.169	5.799	-44.201	12.385	-46.044	22.133
-15.093	-13.641	-30.942	-4.012	-41.147	5.807	-44.219	12.403	-45.617	22.151
-15.106	-13.64	-30.908	-4.002	-41.134	5.815	-44.326	12.412	-45.947	22.162
-15.12	-13.624	-30.851	-3.979	-41.07	5.835	-44.351	12.42	-45.461	22.174
-15.117	-13.608	-30.857	-3.978	-41.054	5.84	-44.297	12.443	-45.939	22.19
-15.151	-13.604	-30.861	-3.959	-41.019	5.86	-44.364	12.449	-45.324	22.199

Annex A

-15.177	-13.579	-30.839	-3.943	-40.968	5.87	-44.412	12.46	-45.869	22.211
-15.185	-13.572	-30.839	-3.939	-40.931	5.874	-44.423	12.479	-45.321	22.233
-15.203	-13.567	-30.779	-3.913	-40.873	5.901	-44.312	12.48	-45.801	22.233
-15.231	-13.543	-30.732	-3.906	-40.835	5.905	-44.22	12.496	-45.271	22.255
-15.301	-13.542	-30.702	-3.898	-40.774	5.92	-44.347	12.504	-45.917	22.259
-15.337	-13.524	-30.672	-3.874	-40.729	5.937	-44.088	12.516	-45.149	22.275
-15.336	-13.508	-30.706	-3.875	-40.731	5.943	-44.298	12.535	-45.852	22.291
-15.397	-13.505	-30.71	-3.848	-40.661	5.964	-44.5	12.538	-45.234	22.295
-15.423	-13.479	-30.698	-3.843	-40.617	5.97	-44.295	12.557	-45.843	22.31
-15.453	-13.476	-30.669	-3.831	-40.59	5.981	-44.514	12.568	-45.129	22.331
-15.464	-13.465	-30.61	-3.809	-40.515	6.005	-44.695	12.573	-45.853	22.329
-15.467	-13.441	-30.621	-3.807	-40.433	6.008	-44.15	12.598	-45.228	22.357
-15.531	-13.444	-30.644	-3.79	-40.432	6.026	-44.437	12.605	-45.813	22.359
-15.534	-13.422	-30.668	-3.776	-40.396	6.04	-44.638	12.617	-45.03	22.379
-15.56	-13.415	-30.703	-3.766	-40.385	6.047	-44.288	12.634	-45.749	22.392
-15.581	-13.403	-30.708	-3.744	-40.385	6.07	-44.707	12.635	-45.205	22.397
-15.607	-13.378	-30.748	-3.742	-40.371	6.072	-44.798	12.658	-45.66	22.418
-15.634	-13.381	-30.88	-3.725	-40.363	6.089	-44.277	12.671	-45.067	22.433
-15.682	-13.359	-31.022	-3.708	-40.329	6.108	-44.59	12.674	-45.695	22.436
-15.703	-13.348	-31.172	-3.712	-40.352	6.107	-44.501	12.696	-45.105	22.461
-15.775	-13.342	-31.305	-3.689	-40.375	6.134	-44.666	12.701	-45.614	22.46
-15.769	-13.319	-31.461	-3.683	-40.391	6.141	-44.629	12.72	-45.15	22.484
-15.793	-13.315	-31.577	-3.669	-40.451	6.153	-44.522	12.732	-45.539	22.492
-15.795	-13.301	-31.596	-3.652	-40.462	6.171	-44.725	12.737	-45.105	22.504
-15.776	-13.281	-31.635	-3.648	-40.496	6.175	-44.757	12.757	-45.618	22.52
-15.804	-13.284	-31.664	-3.629	-40.498	6.195	-44.272	12.769	-45.103	22.529
-15.813	-13.26	-31.702	-3.615	-40.516	6.206	-44.687	12.777	-45.498	22.542
-15.804	-13.253	-31.771	-3.612	-40.589	6.214	-44.808	12.794	-44.98	22.565
-15.852	-13.246	-31.814	-3.589	-40.623	6.236	-44.308	12.803	-45.52	22.558
-15.836	-13.223	-31.867	-3.582	-40.677	6.232	-44.732	12.819	-45.067	22.587
-15.875	-13.222	-31.852	-3.568	-40.722	6.249	-44.776	12.828	-45.454	22.592
-15.858	-13.204	-31.841	-3.554	-40.782	6.262	-44.2	12.845	-44.983	22.607
-15.878	-13.189	-31.888	-3.547	-40.846	6.269	-44.521	12.859	-45.471	22.624
-15.923	-13.187	-31.916	-3.525	-40.863	6.29	-44.642	12.864	-44.912	22.63
-15.952	-13.161	-31.966	-3.519	-40.918	6.295	-44.154	12.881	-45.655	22.645
-15.958	-13.158	-31.995	-3.514	-41.005	6.308	-44.489	12.891	-44.922	22.656
-15.985	-13.147	-32.01	-3.489	-41.046	6.326	-44.697	12.898	-45.654	22.659
-15.974	-13.122	-32.014	-3.49	-41.089	6.329	-44.143	12.924	-45.129	22.687
-16.027	-13.126	-32.035	-3.472	-41.149	6.349	-44.578	12.926	-45.742	22.686
-16.039	-13.102	-32.045	-3.457	-41.205	6.359	-44.595	12.937	-44.966	22.707
-16.056	-13.09	-32.056	-3.454	-41.287	6.367	-44.232	12.96	-45.579	22.72

Annex A

-16.073	-13.085	-32.064	-3.425	-41.346	6.39	-44.587	12.961	-45.364	22.723
-16.08	-13.064	-32.096	-3.424	-41.421	6.39	-44.672	12.984	-45.441	22.748
-16.111	-13.063	-32.105	-3.408	-41.463	6.41	-44.331	12.992	-45.531	22.752
-16.154	-13.043	-32.091	-3.391	-41.479	6.427	-44.66	13	-45.285	22.768
-16.133	-13.026	-32.094	-3.391	-41.555	6.427	-44.386	13.025	-45.819	22.781
-16.113	-13.027	-32.111	-3.365	-41.617	6.449	-44.515	13.025	-45.243	22.79
-16.052	-13.001	-32.125	-3.359	-41.719	6.455	-44.544	13.044	-45.99	22.804
-16.058	-12.996	-32.167	-3.346	-41.803	6.471	-44.589	13.057	-45.07	22.821
-16.048	-12.981	-32.172	-3.325	-41.864	6.486	-44.628	13.065	-45.707	22.823
-16.014	-12.962	-32.17	-3.321	-41.934	6.489	-44.52	13.09	-45.564	22.844
-16.037	-12.962	-32.168	-3.305	-41.997	6.513	-44.575	13.089	-45.497	22.851
-16.047	-12.938	-32.178	-3.289	-42.054	6.522	-44.798	13.102	-45.935	22.862
-16.065	-12.928	-32.205	-3.287	-42.094	6.526	-44.432	13.123	-45.213	22.889
-16.104	-12.927	-32.231	-3.262	-42.14	6.553	-44.65	13.127	-45.996	22.882
-16.117	-12.9	-32.259	-3.259	-42.192	6.551	-44.775	13.141	-45.231	22.911
-16.067	-12.897	-32.288	-3.244	-42.238	6.571	-44.646	13.154	-45.705	22.917
-16.086	-12.882	-32.289	-3.225	-42.263	6.585	-44.673	13.163	-45.542	22.928
-16.107	-12.866	-32.316	-3.223	-42.309	6.59	-44.583	13.187	-45.544	22.951
-16.094	-12.864	-32.322	-3.199	-42.299	6.612	-44.577	13.189	-45.928	22.947
-16.098	-12.84	-32.348	-3.191	-42.368	6.617	-44.755	13.204	-45.466	22.973
-16.121	-12.837	-32.391	-3.182	-42.417	6.629	-44.459	13.225	-46.054	22.978
-16.17	-12.825	-32.409	-3.16	-42.44	6.644	-44.472	13.228	-45.203	22.99
-16.194	-12.804	-32.423	-3.155	-42.454	6.649	-44.681	13.246	-45.942	23.011
-16.224	-12.803	-32.406	-3.142	-42.47	6.671	-44.411	13.257	-45.294	23.014
-16.266	-12.781	-32.382	-3.129	-42.492	6.677	-44.506	13.268	-45.765	23.03
-16.307	-12.767	-32.416	-3.122	-42.495	6.688	-44.675	13.28	-45.605	23.041
-16.41	-12.765	-32.437	-3.101	-42.454	6.711	-44.623	13.287	-45.584	23.051
-16.455	-12.74	-32.475	-3.097	-42.45	6.712	-44.269	13.308	-45.981	23.065
-16.479	-12.738	-32.533	-3.085	-42.446	6.734	-44.512	13.318	-45.389	23.076
-16.541	-12.726	-32.555	-3.062	-42.446	6.745	-44.469	13.329	-46.151	23.082
-16.565	-12.705	-32.523	-3.061	-42.444	6.749	-44.19	13.35	-45.452	23.108
-16.685	-12.707	-32.364	-3.037	-42.431	6.773	-44.473	13.354	-46.054	23.107
-16.699	-12.682	-32.364	-3.03	-42.399	6.781	-44.571	13.368	-45.431	23.131
-16.759	-12.675	-32.388	-3.018	-42.364	6.793	-44.136	13.383	-45.736	23.142
-16.777	-12.667	-32.368	-2.995	-42.322	6.812	-44.478	13.39	-45.814	23.146
-16.766	-12.646	-32.368	-2.994	-42.301	6.814	-44.649	13.409	-45.45	23.175
-16.794	-12.645	-32.348	-2.971	-42.277	6.842	-44.196	13.419	-46.066	23.17
-16.831	-12.621	-32.309	-2.96	-42.248	6.846	-44.489	13.43	-45.286	23.193
-16.838	-12.608	-32.305	-2.955	-42.209	6.855	-44.494	13.452	-46.018	23.204
-16.868	-12.606	-32.308	-2.93	-42.143	6.879	-44.103	13.453	-45.373	23.209
-16.897	-12.581	-32.292	-2.927	-42.102	6.882	-44.409	13.472	-45.856	23.234

Annex A

-16.931	-12.578	-32.296	-2.912	-42.056	6.901	-44.53	13.481	-45.69	23.238
-16.954	-12.563	-32.274	-2.893	-42.054	6.915	-44.475	13.491	-45.642	23.253
-16.947	-12.546	-32.291	-2.891	-42.071	6.921	-44.556	13.511	-45.817	23.268
-16.979	-12.544	-32.255	-2.866	-42.08	6.948	-44.672	13.513	-45.351	23.276
-17.013	-12.519	-32.252	-2.863	-42.087	6.946	-44.368	13.533	-46.002	23.291
-17.041	-12.515	-32.265	-2.849	-42.082	6.963	-44.433	13.55	-45.156	23.305
-17.102	-12.508	-32.258	-2.824	-42.036	6.982	-44.605	13.55	-45.908	23.31
-17.135	-12.488	-32.264	-2.826	-42.029	6.983	-44.383	13.574	-45.321	23.339
-17.166	-12.486	-32.266	-2.804	-42.015	7.01	-44.736	13.576	-45.717	23.338
-17.198	-12.466	-32.247	-2.79	-42.018	7.012	-44.721	13.591	-45.547	23.355
-17.214	-12.455	-32.278	-2.785	-42.034	7.025	-44.459	13.611	-45.473	23.376
-17.277	-12.452	-32.253	-2.762	-42.025	7.045	-44.791	13.614	-45.796	23.372
-17.294	-12.427	-32.261	-2.757	-42.059	7.047	-44.709	13.631	-45.298	23.401
-17.326	-12.425	-32.276	-2.749	-42.07	7.069	-44.582	13.645	-46.032	23.398
-17.37	-12.407	-32.275	-2.728	-42.1	7.079	-44.642	13.652	-45.184	23.419
-17.384	-12.391	-32.312	-2.728	-42.153	7.086	-44.575	13.67	-45.911	23.431
-17.409	-12.391	-32.309	-2.705	-42.173	7.107	-44.653	13.674	-45.264	23.435
-17.428	-12.369	-32.346	-2.697	-42.194	7.113	-44.649	13.688	-45.734	23.451
-17.48	-12.361	-32.382	-2.688	-42.222	7.129	-44.563	13.704	-45.562	23.462
-17.531	-12.354	-32.411	-2.665	-42.236	7.147	-44.723	13.708	-45.622	23.471
-17.552	-12.329	-32.448	-2.666	-42.253	7.15	-44.553	13.734	-45.7	23.49
-17.618	-12.331	-32.504	-2.644	-42.274	7.174	-44.704	13.736	-45.409	23.498
-17.644	-12.311	-32.542	-2.63	-42.294	7.178	-44.811	13.752	-45.988	23.512
-17.658	-12.299	-32.601	-2.629	-42.359	7.191	-44.602	13.771	-46.297	23.524
-17.694	-12.296	-32.615	-2.604	-42.386	7.215	-44.731	13.77	-44.99	23.536
-17.737	-12.271	-32.625	-2.598	-42.393	7.213	-44.837	13.791	-45.608	23.556
-17.779	-12.27	-32.648	-2.585	-42.418	7.234	-45.05	13.801	-45.565	23.562
-17.808	-12.256	-32.662	-2.564	-42.431	7.239	-44.731	13.81	-45.807	23.574
-17.838	-12.236	-32.729	-2.564	-42.448	7.252	-44.951	13.826	-45.497	23.591
-17.892	-12.235	-32.783	-2.539	-42.42	7.274	-45.185	13.832	-45.515	23.595
-17.915	-12.208	-32.827	-2.535	-42.452	7.276	-44.855	13.854	-45.814	23.616
-17.965	-12.205	-32.852	-2.522	-42.452	7.293	-45.139	13.865	-45.405	23.626
-17.975	-12.2	-32.825	-2.501	-42.422	7.312	-45.185	13.865	-45.959	23.628
-17.998	-12.17	-32.872	-2.502	-42.444	7.315	-44.769	13.892	-45.17	23.66
-18.052	-12.172	-32.91	-2.48	-42.422	7.339	-44.983	13.9	-45.902	23.655
-18.071	-12.153	-32.985	-2.469	-42.447	7.342	-45.089	13.91	-45.358	23.676
-18.09	-12.14	-33.058	-2.462	-42.478	7.357	-45.04	13.929	-45.942	23.691
-18.144	-12.134	-33.088	-2.441	-42.508	7.375	-45.19	13.931	-45.321	23.692
-18.133	-12.113	-33.159	-2.438	-42.559	7.375	-45.151	13.953	-45.831	23.718
-18.099	-12.113	-33.203	-2.422	-42.539	7.401	-45.248	13.961	-45.645	23.717
-18.142	-12.099	-33.229	-2.404	-42.524	7.409	-45.176	13.969	-45.759	23.735

Annex A

-18.179	-12.077	-33.269	-2.404	-42.525	7.416	-45.05	13.991	-45.836	23.751
-18.22	-12.077	-33.316	-2.38	-42.527	7.436	-45.276	13.995	-45.649	23.752
-18.227	-12.056	-33.357	-2.366	-42.572	7.438	-45.298	14.014	-45.966	23.774
-18.238	-12.047	-33.417	-2.361	-42.568	7.46	-45.156	14.024	-45.55	23.786
-18.25	-12.038	-33.447	-2.343	-42.564	7.472	-45.335	14.029	-46.208	23.791
-18.27	-12.015	-33.423	-2.34	-42.569	7.474	-45.337	14.05	-45.497	23.814
-18.299	-12.015	-33.428	-2.32	-42.565	7.504	-44.979	14.052	-46.235	23.81
-18.335	-11.995	-33.429	-2.307	-42.553	7.502	-45.288	14.063	-45.647	23.832
-18.314	-11.982	-33.478	-2.305	-42.56	7.519	-45.343	14.083	-46.031	23.844
-18.348	-11.978	-33.485	-2.274	-42.571	7.541	-45.14	14.092	-45.992	23.842
-18.356	-11.952	-33.527	-2.275	-42.577	7.54	-45.166	14.108	-46.008	23.873
-18.385	-11.951	-33.575	-2.258	-42.561	7.565	-45.217	14.117	-46.317	23.87
-18.429	-11.938	-33.572	-2.243	-42.563	7.572	-45.156	14.128	-46.063	23.888
-18.451	-11.912	-33.618	-2.241	-42.589	7.582	-45.113	14.147	-46.295	23.899
-18.498	-11.917	-33.64	-2.214	-42.566	7.605	-45.014	14.151	-45.791	23.91
-18.536	-11.892	-33.681	-2.209	-42.6	7.604	-45.105	14.172	-46.464	23.928
-18.531	-11.886	-33.753	-2.2	-42.645	7.625	-45.168	14.186	-45.567	23.936
-18.566	-11.876	-33.769	-2.176	-42.67	7.638	-44.911	14.189	-46.304	23.945
-18.581	-11.851	-33.811	-2.177	-42.699	7.643	-45.086	14.213	-45.821	23.97
-18.632	-11.852	-33.798	-2.153	-42.701	7.664	-45.171	14.219	-46.185	23.97
-18.667	-11.836	-33.786	-2.143	-42.684	7.671	-44.877	14.231	-45.899	23.989
-18.654	-11.817	-33.824	-2.138	-42.707	7.684	-45.008	14.248	-45.973	24.001
-18.679	-11.814	-33.826	-2.111	-42.678	7.703	-45.055	14.253	-45.921	24.007
-18.67	-11.792	-33.841	-2.109	-42.723	7.705	-44.899	14.278	-45.761	24.034
-18.68	-11.788	-33.843	-2.092	-42.774	7.729	-45.174	14.281	-46.181	24.028
-18.734	-11.774	-33.814	-2.074	-42.84	7.734	-45.129	14.289	-45.753	24.051
-18.746	-11.757	-33.787	-2.074	-42.873	7.741	-44.977	14.317	-46.309	24.061
-18.818	-11.751	-33.796	-2.049	-42.911	7.766	-45.192	14.316	-45.635	24.067
-18.859	-11.736	-33.837	-2.041	-42.974	7.764	-45.048	14.334	-46.276	24.089
-18.879	-11.725	-33.879	-2.033	-42.992	7.788	-45.138	14.348	-45.551	24.099
-18.923	-11.719	-33.868	-2.009	-42.976	7.798	-45.33	14.356	-46.201	24.102
-18.926	-11.696	-33.772	-2.004	-42.995	7.797	-44.843	14.377	-45.297	24.133
-18.974	-11.694	-33.761	-1.983	-42.994	7.825	-45.185	14.377	-46.04	24.128
-19.008	-11.678	-33.773	-1.975	-43.019	7.827	-45.324	14.393	-45.621	24.153
-19.011	-11.658	-33.827	-1.972	-42.996	7.842	-44.993	14.412	-46.029	24.16
-19.054	-11.66	-33.843	-1.948	-42.98	7.861	-45.127	14.414	-45.464	24.167
-19.073	-11.635	-33.877	-1.945	-42.998	7.861	-45.235	14.434	-45.74	24.193
-19.119	-11.63	-33.9	-1.932	-42.993	7.89	-45.134	14.444	-45.744	24.19
-19.127	-11.617	-33.916	-1.911	-42.981	7.892	-45.133	14.451	-45.541	24.211
-19.106	-11.597	-33.962	-1.911	-42.989	7.903	-45.212	14.47	-45.887	24.222
-19.161	-11.599	-33.952	-1.886	-42.964	7.928	-45.079	14.475	-45.3	24.229

Annex A

-19.208	-11.574	-33.945	-1.88	-42.935	7.925	-44.989	14.493	-46.025	24.247
-19.24	-11.565	-33.959	-1.871	-42.917	7.95	-45.233	14.507	-45.154	24.254
-19.265	-11.559	-33.965	-1.849	-42.909	7.959	-45.172	14.513	-45.833	24.265
-19.257	-11.532	-33.981	-1.845	-42.914	7.965	-45.06	14.536	-45.381	24.287
-19.266	-11.536	-33.993	-1.826	-42.898	7.991	-45.301	14.536	-45.684	24.286
-19.279	-11.517	-34.012	-1.812	-42.901	7.993	-45.281	14.554	-45.481	24.307
-19.275	-11.5	-34.037	-1.81	-42.873	8.012	-44.92	14.574	-45.463	24.319
-19.304	-11.501	-34.039	-1.786	-42.831	8.027	-45.236	14.575	-45.67	24.323
-19.29	-11.473	-34.032	-1.782	-42.859	8.029	-45.327	14.599	-45.246	24.349
-19.295	-11.471	-34.053	-1.765	-42.827	8.057	-45.079	14.604	-45.907	24.347
-19.287	-11.456	-34.058	-1.746	-42.784	8.059	-45.324	14.615	-44.552	24.366
-19.275	-11.436	-34.089	-1.745	-42.764	8.072	-45.122	14.636	-44.29	24.372
-19.297	-11.434	-34.133	-1.72	-42.706	8.096	-45.229	14.636	-44.163	24.371
-19.312	-11.411	-34.184	-1.715	-42.669	8.096	-45.039	14.656	-44.071	24.375
-19.348	-11.404	-34.238	-1.706	-42.626	8.118	-45.304	14.67	-43.992	24.37
-19.411	-11.398	-34.226	-1.681	-42.563	8.126	-45.367	14.674		
-19.457	-11.376	-34.261	-1.681	-42.535	8.135	-44.97	14.702		
-19.471	-11.376	-34.28	-1.66	-42.476	8.164	-45.233	14.7		

Table 10. Shear Trial 4 Results.

F (Kg)	D (mm)	F (Kg)	D (mm)	F (Kg)	D (mm)	F (Kg)	D (mm)	F (Kg)	D (mm)
-1.978	6.277	12.797	4.317	6.454	0.257	4.29	-3.686	3.067	-7.837
-1.972	6.273	12.79	4.32	6.43	0.247	4.285	-3.7	3.061	-7.843
-1.999	6.269	12.738	4.302	6.454	0.247	4.279	-3.705	3.081	-7.85
-1.974	6.28	12.716	4.298	6.434	0.229	4.289	-3.704	3.046	-7.877
-1.973	6.271	12.698	4.294	6.435	0.23	4.286	-3.721	3.062	-7.873
-1.99	6.271	12.65	4.277	6.439	0.226	4.291	-3.72	3.06	-7.898
-1.969	6.281	12.647	4.288	6.425	0.209	4.304	-3.723	3.057	-7.915
-1.983	6.269	12.634	4.271	6.4	0.211	4.285	-3.74	3.061	-7.913
-1.988	6.274	12.577	4.257	6.401	0.202	4.262	-3.736	3.065	-7.94
-1.976	6.277	12.528	4.266	6.402	0.193	4.263	-3.748	3.055	-7.949
-1.994	6.269	12.367	4.24	6.391	0.193	4.292	-3.758	3.056	-7.956
-1.976	6.278	12.18	4.231	6.407	0.182	4.298	-3.755	3.018	-7.982
-1.974	6.276	12.007	4.227	6.396	0.176	4.3	-3.769	3.023	-7.981
-1.989	6.268	11.782	4.202	6.418	0.177	4.292	-3.774	3.045	-8.001
-1.983	6.28	11.654	4.205	6.419	0.161	4.302	-3.776	3.022	-8.023
-1.982	6.272	11.481	4.187	6.401	0.16	4.295	-3.79	3.04	-8.019
-1.99	6.272	11.076	4.16	6.4	0.155	4.283	-3.791	3.05	-8.04
-1.974	6.281	10.593	4.156	6.361	0.139	4.279	-3.797	3.031	-8.061

Annex A

-1.976	6.27	10.431	4.134	6.383	0.141	4.267	-3.815	3.045	-8.056
-1.993	6.275	10.315	4.12	6.379	0.128	4.281	-3.81	3.043	-8.082
-1.969	6.28	10.294	4.123	6.363	0.12	4.271	-3.817	3.042	-8.093
-1.998	6.268	10.257	4.103	6.367	0.121	4.252	-3.829	3.04	-8.104
-1.968	6.276	10.222	4.1	6.341	0.109	4.261	-3.828	3.008	-8.128
-1.974	6.276	10.195	4.099	6.37	0.104	4.249	-3.844	3.02	-8.125
-1.985	6.269	10.126	4.077	6.368	0.1	4.263	-3.842	3.035	-8.142
-1.972	6.279	10.101	4.083	6.357	0.084	4.289	-3.848	2.989	-8.165
-1.975	6.271	10.086	4.074	6.36	0.088	4.287	-3.865	2.989	-8.162
-1.99	6.271	10.044	4.058	6.388	0.083	4.285	-3.86	2.997	-8.184
-1.978	6.281	10.024	4.063	6.338	0.068	4.297	-3.867	2.974	-8.199
-1.968	6.269	10.036	4.045	6.352	0.071	4.293	-3.882	3.004	-8.2
-2.002	6.273	10.022	4.039	6.341	0.059	4.295	-3.878	2.999	-8.227
-1.974	6.279	10.004	4.044	6.312	0.046	4.29	-3.891	2.99	-8.23
-1.988	6.27	10.009	4.022	6.312	0.046	4.281	-3.899	3.025	-8.241
-1.984	6.276	10.021	4.023	6.299	0.034	4.286	-3.897	3.006	-8.263
-1.981	6.276	10.039	4.023	6.307	0.031	4.241	-3.915	3.023	-8.262
-1.994	6.269	10.018	4.003	6.325	0.025	4.239	-3.913	3.022	-8.282
-1.977	6.28	10.018	4.005	6.263	0.015	4.258	-3.917	2.977	-8.302
-1.977	6.273	10.004	3.995	6.303	0.016	4.24	-3.934	2.993	-8.3
-1.988	6.271	9.969	3.984	6.306	0.008	4.24	-3.929	2.965	-8.325
-1.971	6.282	9.997	3.993	6.304	-0.008	4.248	-3.943	2.927	-8.34
-1.98	6.271	9.959	3.972	6.31	-0.002	4.269	-3.951	2.947	-8.34
-1.997	6.271	9.95	3.963	6.304	-0.012	4.262	-3.948	2.944	-8.366
-1.973	6.279	9.976	3.97	6.289	-0.018	4.254	-3.965	2.934	-8.374
-1.982	6.269	9.962	3.948	6.327	-0.018	4.255	-3.968	2.949	-8.384
-1.98	6.276	9.941	3.95	6.286	-0.037	4.246	-3.968	2.931	-8.407
-1.972	6.276	9.962	3.944	6.273	-0.037	4.234	-3.987	2.944	-8.407
-1.986	6.268	9.918	3.93	6.28	-0.042	4.249	-3.987	2.949	-8.427
-1.978	6.279	9.956	3.934	6.246	-0.059	4.256	-3.992	2.919	-8.442
-1.975	6.273	9.928	3.919	6.287	-0.055	4.215	-4.008	2.947	-8.442
-1.997	6.27	9.9	3.909	6.257	-0.066	4.225	-3.999	2.923	-8.472
-1.973	6.28	9.882	3.916	6.222	-0.076	4.213	-4.015	2.895	-8.482
-1.978	6.271	9.911	3.897	6.237	-0.074	4.203	-4.024	2.922	-8.485
-1.985	6.273	9.861	3.892	6.231	-0.088	4.195	-4.02	2.921	-8.511
-1.969	6.281	9.894	3.899	6.21	-0.095	4.19	-4.036	2.921	-8.512
-1.98	6.269	9.902	3.877	6.229	-0.094	4.188	-4.04	2.92	-8.529
-1.983	6.275	9.913	3.88	6.223	-0.106	4.187	-4.047	2.907	-8.549
-1.974	6.278	9.925	3.875	6.195	-0.114	4.157	-4.062	2.914	-8.547
-1.983	6.27	9.927	3.862	6.185	-0.117	4.158	-4.057	2.917	-8.573
-1.977	6.277	9.932	3.865	6.169	-0.133	4.166	-4.069	2.907	-8.587

Annex A

-1.973	6.273	9.912	3.85	6.185	-0.13	4.148	-4.08	2.92	-8.587
-1.99	6.269	9.951	3.843	6.136	-0.145	4.17	-4.075	2.92	-8.607
-1.968	6.28	9.951	3.848	6.135	-0.154	4.178	-4.09	2.908	-8.619
-1.979	6.271	9.962	3.831	6.171	-0.146	4.162	-4.097	2.911	-8.624
-1.99	6.271	9.964	3.827	6.153	-0.164	4.173	-4.096	2.899	-8.653
-1.972	6.281	10.008	3.827	6.143	-0.169	4.164	-4.113	2.888	-8.649
-1.987	6.269	10	3.808	6.138	-0.171	4.158	-4.108	2.892	-8.671
-1.983	6.274	10.002	3.813	6.144	-0.186	4.163	-4.115	2.869	-8.688
-1.971	6.278	10.01	3.808	6.141	-0.183	4.139	-4.133	2.888	-8.687
-1.985	6.271	10.009	3.788	6.151	-0.189	4.141	-4.129	2.888	-8.707
-1.974	6.278	10.007	3.796	6.124	-0.205	4.146	-4.143	2.865	-8.721
-1.967	6.274	9.996	3.778	6.106	-0.199	4.15	-4.15	2.874	-8.726
-1.987	6.27	9.977	3.774	6.115	-0.216	4.169	-4.145	2.867	-8.754
-1.981	6.28	9.983	3.777	6.096	-0.226	4.165	-4.165	2.861	-8.757
-1.827	6.278	9.996	3.756	6.11	-0.223	4.145	-4.168	2.896	-8.765
-1.701	6.269	9.997	3.754	6.079	-0.242	4.162	-4.17	2.875	-8.793
-1.581	6.276	10.008	3.758	6.079	-0.243	4.179	-4.184	2.892	-8.792
-1.479	6.278	10.006	3.738	6.072	-0.248	4.196	-4.183	2.887	-8.807
-1.365	6.267	9.999	3.74	6.057	-0.264	4.195	-4.19	2.861	-8.828
-1.19	6.277	10.027	3.735	6.072	-0.259	4.195	-4.2	2.876	-8.831
-1.042	6.272	10.004	3.72	6.072	-0.268	4.188	-4.196	2.881	-8.854
-0.906	6.271	10.012	3.722	6.054	-0.28	4.198	-4.215	2.842	-8.865
-0.781	6.279	9.987	3.712	6.066	-0.277	4.183	-4.22	2.852	-8.866
-0.679	6.269	9.965	3.702	6.079	-0.291	4.194	-4.215	2.869	-8.896
-0.568	6.27	9.981	3.707	6.04	-0.298	4.183	-4.239	2.869	-8.9
-0.483	6.276	9.97	3.684	6.057	-0.296	4.16	-4.236	2.873	-8.91
-0.45	6.269	9.935	3.686	6.048	-0.314	4.164	-4.239	2.846	-8.933
-0.439	6.273	9.969	3.681	6.037	-0.314	4.145	-4.257	2.853	-8.938
-0.39	6.275	9.92	3.666	6.046	-0.318	4.158	-4.252	2.865	-8.954
-0.381	6.264	9.962	3.667	6.061	-0.337	4.174	-4.261	2.829	-8.969
-0.343	6.278	9.97	3.657	6.067	-0.331	4.164	-4.275	2.847	-8.97
-0.326	6.27	9.919	3.645	6.056	-0.342	4.168	-4.269	2.838	-8.997
-0.319	6.267	9.914	3.648	6.036	-0.35	4.149	-4.284	2.8	-9.006
-0.3	6.275	9.902	3.634	6.048	-0.349	4.133	-4.29	2.831	-9.007
-0.294	6.268	9.877	3.627	6.049	-0.363	4.154	-4.285	2.81	-9.036
-0.282	6.273	9.841	3.626	6.052	-0.367	4.131	-4.307	2.823	-9.035
-0.251	6.275	9.835	3.609	6.053	-0.368	4.117	-4.304	2.84	-9.05
-0.26	6.27	9.814	3.608	6.064	-0.383	4.121	-4.312	2.826	-9.074
-0.236	6.273	9.783	3.604	6.048	-0.385	4.109	-4.326	2.824	-9.073
-0.223	6.275	9.744	3.587	6.062	-0.387	4.129	-4.32	2.83	-9.091
-0.211	6.264	9.73	3.59	6.045	-0.401	4.127	-4.334	2.805	-9.111

Annex A

-0.183	6.276	9.718	3.577	6.042	-0.399	4.124	-4.345	2.817	-9.113
-0.141	6.273	9.696	3.567	6.045	-0.413	4.154	-4.338	2.803	-9.138
-0.122	6.267	9.702	3.568	6.014	-0.42	4.157	-4.356	2.789	-9.143
-0.082	6.276	9.7	3.556	6.021	-0.416	4.141	-4.357	2.827	-9.151
-0.059	6.265	9.672	3.55	6	-0.436	4.16	-4.359	2.795	-9.182
-0.042	6.273	9.669	3.548	5.992	-0.437	4.148	-4.38	2.807	-9.179
-0.011	6.275	9.656	3.531	6.003	-0.437	4.144	-4.37	2.812	-9.191
-0.01	6.265	9.643	3.53	6	-0.454	4.154	-4.384	2.79	-9.219
0.001	6.275	9.655	3.53	6.012	-0.452	4.132	-4.398	2.796	-9.214
0.034	6.273	9.628	3.51	6.015	-0.462	4.14	-4.391	2.817	-9.236
0.075	6.264	9.624	3.513	6.013	-0.472	4.127	-4.406	2.813	-9.249
0.155	6.274	9.604	3.504	6.016	-0.471	4.1	-4.414	2.808	-9.255
0.212	6.271	9.594	3.499	5.999	-0.485	4.112	-4.41	2.795	-9.281
0.272	6.267	9.604	3.498	5.984	-0.493	4.111	-4.434	2.784	-9.284
0.337	6.273	9.57	3.481	5.987	-0.489	4.102	-4.429	2.816	-9.291
0.389	6.267	9.557	3.48	5.98	-0.505	4.099	-4.432	2.789	-9.319
0.432	6.269	9.562	3.481	5.973	-0.512	4.076	-4.456	2.804	-9.32
0.491	6.273	9.541	3.459	5.97	-0.513	4.079	-4.448	2.808	-9.332
0.478	6.264	9.511	3.461	5.973	-0.531	4.077	-4.458	2.778	-9.357
0.515	6.274	9.504	3.455	5.965	-0.526	4.065	-4.472	2.78	-9.358
0.554	6.271	9.475	3.439	5.975	-0.534	4.079	-4.464	2.776	-9.379
0.559	6.263	9.44	3.441	5.958	-0.546	4.077	-4.484	2.764	-9.39
0.606	6.274	9.428	3.431	5.966	-0.545	4.047	-4.486	2.775	-9.389
0.621	6.271	9.408	3.418	5.959	-0.559	4.054	-4.483	2.749	-9.416
0.643	6.264	9.381	3.419	5.948	-0.561	4.035	-4.509	2.744	-9.421
0.687	6.273	9.352	3.408	5.969	-0.564	4.041	-4.5	2.775	-9.431
0.717	6.264	9.32	3.401	5.953	-0.58	4.042	-4.505	2.749	-9.457
0.731	6.269	9.318	3.4	5.95	-0.581	4.01	-4.524	2.744	-9.456
0.765	6.274	9.308	3.381	5.951	-0.583	4.017	-4.517	2.757	-9.47
0.783	6.26	9.275	3.383	5.926	-0.602	4.039	-4.531	2.744	-9.494
0.809	6.273	9.263	3.376	5.938	-0.598	4.025	-4.541	2.759	-9.493
0.851	6.271	9.253	3.358	5.913	-0.608	4.027	-4.535	2.747	-9.516
0.858	6.261	9.241	3.359	5.909	-0.618	4.02	-4.557	2.758	-9.528
0.897	6.273	9.216	3.352	5.929	-0.619	4.019	-4.557	2.758	-9.536
0.913	6.265	9.161	3.34	5.91	-0.634	4.027	-4.557	2.732	-9.56
0.927	6.266	9.153	3.339	5.899	-0.634	4.022	-4.578	2.72	-9.561
0.963	6.271	9.113	3.325	5.902	-0.635	4.032	-4.569	2.721	-9.576
0.984	6.263	9.088	3.323	5.881	-0.654	4.044	-4.58	2.695	-9.601
1.01	6.269	9.097	3.319	5.878	-0.653	4.01	-4.602	2.691	-9.597
1.049	6.271	9.061	3.299	5.897	-0.658	4.017	-4.588	2.703	-9.619
1.067	6.257	9.039	3.304	5.901	-0.669	4.019	-4.606	2.691	-9.636

Annex A

1.091	6.271	9.051	3.3	5.884	-0.672	4.004	-4.614	2.711	-9.641
1.144	6.265	9.022	3.283	5.871	-0.684	4.023	-4.609	2.722	-9.66
1.148	6.261	9.021	3.286	5.875	-0.692	4.001	-4.629	2.72	-9.669
1.192	6.273	9.003	3.271	5.888	-0.689	4.019	-4.624	2.738	-9.678
1.218	6.266	8.962	3.266	5.875	-0.705	4.047	-4.632	2.712	-9.701
1.242	6.263	8.939	3.264	5.874	-0.707	4.032	-4.648	2.728	-9.705
1.293	6.269	8.898	3.243	5.876	-0.708	4.025	-4.64	2.721	-9.72
1.312	6.257	8.86	3.246	5.866	-0.725	4.061	-4.65	2.697	-9.741
1.358	6.267	8.861	3.24	5.876	-0.723	4.022	-4.669	2.705	-9.743
1.416	6.267	8.841	3.222	5.876	-0.731	4.032	-4.66	2.672	-9.759
1.437	6.258	8.775	3.225	5.858	-0.746	4.01	-4.673	2.637	-9.776
1.479	6.27	8.794	3.215	5.843	-0.742	3.999	-4.682	2.66	-9.777
1.53	6.262	8.79	3.205	5.822	-0.755	4.021	-4.681	2.65	-9.801
1.532	6.259	8.78	3.206	5.804	-0.763	3.993	-4.704	2.645	-9.808
1.603	6.271	8.784	3.192	5.825	-0.764	3.998	-4.695	2.675	-9.82
1.608	6.26	8.75	3.186	5.81	-0.78	4.008	-4.698	2.649	-9.842
1.643	6.264	8.72	3.187	5.813	-0.776	3.992	-4.715	2.656	-9.843
1.692	6.271	8.706	3.168	5.825	-0.78	4.01	-4.704	2.652	-9.86
1.699	6.259	8.686	3.171	5.799	-0.799	4.033	-4.719	2.644	-9.879
1.737	6.269	8.69	3.161	5.809	-0.794	4.027	-4.728	2.654	-9.878
1.787	6.264	8.663	3.145	5.824	-0.798	4.05	-4.722	2.66	-9.903
1.796	6.259	8.67	3.149	5.809	-0.813	4.044	-4.739	2.654	-9.917
1.849	6.27	8.644	3.137	5.843	-0.811	4.028	-4.747	2.666	-9.919
1.877	6.263	8.625	3.127	5.838	-0.827	4.038	-4.743	2.661	-9.945
1.906	6.257	8.641	3.129	5.836	-0.827	4.02	-4.761	2.665	-9.948
1.963	6.27	8.625	3.115	5.846	-0.83	4.027	-4.759	2.679	-9.961
1.989	6.26	8.609	3.113	5.815	-0.848	4.036	-4.769	2.676	-9.983
2.025	6.261	8.617	3.114	5.826	-0.846	4.03	-4.784	2.671	-9.984
2.086	6.267	8.603	3.098	5.825	-0.851	4.017	-4.776	2.675	-10.002
2.093	6.254	8.572	3.1	5.786	-0.871	4.009	-4.79	2.673	-10.02
2.133	6.265	8.561	3.095	5.773	-0.867	3.996	-4.803	2.685	-10.017
2.188	6.261	8.569	3.078	5.771	-0.877	4.003	-4.795	2.679	-10.04
2.22	6.252	8.562	3.082	5.765	-0.886	3.998	-4.81	2.675	-10.057
2.287	6.268	8.564	3.069	5.768	-0.884	3.979	-4.817	2.687	-10.059
2.375	6.258	8.551	3.06	5.757	-0.899	3.981	-4.819	2.656	-10.082
2.435	6.254	8.55	3.059	5.745	-0.904	3.969	-4.836	2.663	-10.09
2.518	6.265	8.529	3.045	5.756	-0.905	3.948	-4.832	2.661	-10.103
2.602	6.253	8.517	3.044	5.748	-0.925	3.941	-4.842	2.65	-10.123
2.658	6.258	8.498	3.038	5.751	-0.919	3.915	-4.857	2.66	-10.123
2.744	6.259	8.482	3.022	5.762	-0.928	3.906	-4.848	2.668	-10.143
2.782	6.249	8.468	3.026	5.754	-0.942	3.9	-4.866	2.664	-10.161

Annex A

2.844	6.261	8.46	3.018	5.777	-0.936	3.888	-4.875	2.684	-10.157
2.906	6.259	8.445	3.003	5.776	-0.95	3.897	-4.872	2.678	-10.182
2.878	6.247	8.433	3.007	5.779	-0.958	3.867	-4.889	2.665	-10.188
2.86	6.263	8.422	2.993	5.773	-0.957	3.863	-4.892	2.667	-10.2
2.844	6.251	8.42	2.985	5.762	-0.973	3.87	-4.896	2.643	-10.221
2.83	6.253	8.425	2.985	5.758	-0.974	3.858	-4.909	2.641	-10.227
2.851	6.263	8.401	2.969	5.768	-0.978	3.865	-4.905	2.658	-10.239
2.842	6.248	8.407	2.967	5.754	-0.994	3.874	-4.917	2.638	-10.264
2.84	6.257	8.41	2.963	5.754	-0.992	3.865	-4.929	2.631	-10.264
2.843	6.26	8.38	2.948	5.787	-0.998	3.863	-4.927	2.656	-10.283
2.834	6.248	8.381	2.95	5.767	-1.01	3.867	-4.939	2.65	-10.298
2.841	6.26	8.354	2.941	5.782	-1.006	3.87	-4.947	2.662	-10.298
2.837	6.253	8.316	2.927	5.767	-1.023	3.892	-4.944	2.648	-10.329
2.826	6.249	8.31	2.932	5.776	-1.028	3.891	-4.964	2.636	-10.336
2.847	6.264	8.322	2.918	5.769	-1.029	3.899	-4.963	2.643	-10.341
2.855	6.25	8.312	2.911	5.767	-1.044	3.904	-4.967	2.645	-10.367
2.867	6.248	8.308	2.91	5.77	-1.044	3.884	-4.984	2.634	-10.37
2.941	6.261	8.314	2.894	5.78	-1.054	3.899	-4.978	2.629	-10.388
3.001	6.247	8.303	2.893	5.773	-1.067	3.894	-4.988	2.616	-10.402
3.083	6.251	8.301	2.887	5.78	-1.058	3.895	-4.999	2.626	-10.407
3.18	6.256	8.277	2.874	5.783	-1.073	3.881	-4.996	2.611	-10.428
3.233	6.248	8.283	2.88	5.77	-1.083	3.886	-5.012	2.549	-10.444
3.328	6.259	8.307	2.865	5.774	-1.08	3.862	-5.016	2.565	-10.443
3.396	6.248	8.291	2.855	5.796	-1.095	3.866	-5.015	2.57	-10.472
3.453	6.244	8.306	2.859	5.784	-1.099	3.868	-5.031	2.571	-10.48
3.518	6.257	8.301	2.843	5.792	-1.098	3.865	-5.036	2.567	-10.49
3.602	6.245	8.292	2.838	5.781	-1.116	3.871	-5.035	2.549	-10.512
3.643	6.245	8.296	2.838	5.793	-1.112	3.841	-5.054	2.55	-10.513
3.722	6.254	8.287	2.824	5.787	-1.123	3.854	-5.052	2.555	-10.531
3.787	6.242	8.285	2.824	5.777	-1.136	3.87	-5.062	2.552	-10.55
3.85	6.248	8.28	2.814	5.778	-1.131	3.84	-5.073	2.584	-10.546
3.928	6.246	8.258	2.803	5.781	-1.145	3.844	-5.067	2.578	-10.568
3.955	6.237	8.27	2.807	5.759	-1.151	3.827	-5.083	2.577	-10.58
3.988	6.248	8.262	2.792	5.757	-1.152	3.83	-5.087	2.582	-10.583
4.049	6.246	8.23	2.779	5.742	-1.168	3.834	-5.085	2.576	-10.607
4.072	6.237	8.22	2.783	5.757	-1.168	3.829	-5.101	2.58	-10.616
4.131	6.248	8.212	2.767	5.779	-1.174	3.824	-5.106	2.591	-10.624
4.158	6.236	8.198	2.767	5.754	-1.185	3.841	-5.106	2.555	-10.649
4.198	6.24	8.208	2.76	5.751	-1.18	3.844	-5.123	2.553	-10.649
4.262	6.245	8.197	2.747	5.77	-1.19	3.827	-5.119	2.557	-10.666
4.303	6.236	8.193	2.748	5.767	-1.201	3.836	-5.132	2.553	-10.684

Annex A

4.363	6.24	8.203	2.741	5.764	-1.197	3.832	-5.142	2.559	-10.687
4.408	6.244	8.183	2.731	5.747	-1.214	3.835	-5.139	2.553	-10.712
4.458	6.232	8.179	2.736	5.735	-1.217	3.83	-5.155	2.538	-10.717
4.534	6.243	8.164	2.72	5.736	-1.218	3.807	-5.16	2.557	-10.725
4.607	6.236	8.149	2.715	5.722	-1.237	3.819	-5.159	2.57	-10.751
4.662	6.234	8.159	2.715	5.712	-1.237	3.818	-5.174	2.573	-10.755
4.755	6.245	8.132	2.697	5.72	-1.242	3.813	-5.175	2.595	-10.763
4.823	6.233	8.104	2.692	5.715	-1.257	3.824	-5.177	2.591	-10.787
4.882	6.235	8.124	2.693	5.707	-1.253	3.806	-5.194	2.594	-10.791
4.971	6.241	8.1	2.679	5.716	-1.268	3.793	-5.195	2.577	-10.807
5.038	6.23	8.104	2.678	5.701	-1.274	3.801	-5.199	2.558	-10.822
5.129	6.237	8.118	2.669	5.711	-1.267	3.799	-5.214	2.57	-10.826
5.205	6.238	8.114	2.659	5.705	-1.288	3.809	-5.213	2.564	-10.853
5.247	6.229	8.113	2.66	5.715	-1.292	3.826	-5.225	2.557	-10.859
5.338	6.239	8.101	2.645	5.726	-1.294	3.796	-5.233	2.578	-10.863
5.41	6.233	8.095	2.642	5.687	-1.311	3.8	-5.227	2.564	-10.892
5.468	6.228	8.093	2.642	5.684	-1.308	3.794	-5.25	2.566	-10.897
5.566	6.236	8.092	2.625	5.68	-1.32	3.795	-5.25	2.56	-10.907
5.648	6.227	8.076	2.623	5.639	-1.332	3.794	-5.25	2.569	-10.926
5.703	6.226	8.071	2.616	5.645	-1.326	3.761	-5.269	2.578	-10.926
5.807	6.231	8.054	2.602	5.628	-1.344	3.768	-5.265	2.573	-10.95
5.872	6.222	8.04	2.607	5.611	-1.349	3.754	-5.277	2.554	-10.961
5.941	6.228	8.065	2.591	5.631	-1.347	3.763	-5.286	2.569	-10.963
6.026	6.224	8.03	2.584	5.618	-1.365	3.767	-5.281	2.557	-10.991
6.079	6.215	8.037	2.589	5.602	-1.363	3.758	-5.299	2.524	-10.993
6.166	6.226	8.026	2.573	5.609	-1.368	3.76	-5.303	2.515	-11.006
6.221	6.216	8.029	2.568	5.593	-1.385	3.768	-5.301	2.505	-11.031
6.257	6.213	8.047	2.568	5.61	-1.38	3.771	-5.316	2.52	-11.03
6.313	6.221	8.043	2.551	5.609	-1.391	3.773	-5.323	2.527	-11.046
6.352	6.212	8.057	2.551	5.588	-1.402	3.771	-5.324	2.527	-11.068
6.394	6.208	8.042	2.546	5.615	-1.4	3.751	-5.338	2.536	-11.068
6.455	6.214	8.024	2.532	5.616	-1.417	3.754	-5.337	2.555	-11.09
6.499	6.205	8.046	2.534	5.602	-1.418	3.756	-5.347	2.541	-11.099
6.555	6.207	8.05	2.522	5.598	-1.421	3.756	-5.357	2.559	-11.105
6.62	6.21	8.03	2.515	5.573	-1.44	3.76	-5.357	2.544	-11.132
6.674	6.197	8.025	2.514	5.566	-1.437	3.752	-5.37	2.53	-11.135
6.735	6.207	8.015	2.5	5.576	-1.441	3.736	-5.374	2.534	-11.146
6.794	6.199	7.994	2.495	5.573	-1.459	3.744	-5.373	2.53	-11.174
6.815	6.195	8.004	2.493	5.569	-1.454	3.718	-5.396	2.539	-11.172
6.898	6.202	7.976	2.477	5.557	-1.469	3.723	-5.389	2.534	-11.185
6.944	6.189	7.985	2.479	5.534	-1.474	3.735	-5.393	2.508	-11.211

Annex A

6.986	6.192	7.98	2.47	5.554	-1.472	3.723	-5.414	2.518	-11.21
7.041	6.197	7.949	2.459	5.551	-1.49	3.717	-5.409	2.519	-11.235
7.068	6.184	7.962	2.459	5.532	-1.491	3.721	-5.419	2.525	-11.242
7.117	6.189	7.945	2.446	5.543	-1.494	3.714	-5.429	2.532	-11.248
7.181	6.187	7.936	2.44	5.518	-1.516	3.729	-5.427	2.509	-11.274
7.272	6.18	7.949	2.443	5.503	-1.509	3.727	-5.445	2.519	-11.275
7.346	6.186	7.954	2.424	5.51	-1.52	3.705	-5.445	2.509	-11.291
7.439	6.175	7.94	2.422	5.495	-1.531	3.715	-5.446	2.5	-11.312
7.481	6.169	7.942	2.419	5.508	-1.525	3.701	-5.465	2.491	-11.315
7.579	6.177	7.927	2.403	5.501	-1.543	3.698	-5.464	2.487	-11.331
7.613	6.16	7.939	2.406	5.489	-1.546	3.693	-5.469	2.497	-11.344
7.672	6.159	7.943	2.396	5.493	-1.545	3.694	-5.482	2.521	-11.346
7.748	6.16	7.922	2.387	5.486	-1.562	3.698	-5.48	2.511	-11.371
7.798	6.146	7.913	2.388	5.47	-1.561	3.707	-5.49	2.521	-11.376
7.872	6.152	7.9	2.371	5.493	-1.563	3.705	-5.498	2.546	-11.384
7.924	6.147	7.882	2.368	5.476	-1.583	3.719	-5.495	2.523	-11.414
7.984	6.137	7.899	2.369	5.484	-1.571	3.702	-5.515	2.533	-11.412
8.046	6.142	7.891	2.348	5.495	-1.587	3.7	-5.518	2.553	-11.426
8.123	6.129	7.9	2.353	5.462	-1.596	3.713	-5.516	2.525	-11.447
8.182	6.12	7.922	2.348	5.462	-1.59	3.695	-5.533	2.508	-11.449
8.25	6.132	7.9	2.335	5.435	-1.613	3.696	-5.531	2.488	-11.475
8.342	6.119	7.897	2.336	5.438	-1.612	3.702	-5.537	2.487	-11.484
8.396	6.112	7.882	2.323	5.46	-1.612	3.681	-5.553	2.525	-11.488
8.46	6.114	7.866	2.316	5.44	-1.634	3.692	-5.549	2.518	-11.511
8.514	6.102	7.876	2.319	5.43	-1.625	3.704	-5.56	2.526	-11.515
8.58	6.106	7.868	2.3	5.442	-1.637	3.683	-5.567	2.545	-11.525
8.628	6.102	7.875	2.298	5.437	-1.652	3.698	-5.566	2.524	-11.552
8.694	6.09	7.855	2.296	5.439	-1.644	3.679	-5.581	2.527	-11.547
8.747	6.096	7.862	2.281	5.433	-1.659	3.662	-5.584	2.548	-11.569
8.818	6.087	7.858	2.282	5.422	-1.667	3.685	-5.59	2.522	-11.587
8.856	6.082	7.857	2.274	5.44	-1.663	3.651	-5.605	2.516	-11.587
8.94	6.082	7.862	2.26	5.422	-1.686	3.641	-5.605	2.529	-11.606
9	6.07	7.877	2.263	5.396	-1.685	3.652	-5.613	2.505	-11.624
9.04	6.071	7.872	2.253	5.393	-1.688	3.638	-5.625	2.52	-11.627
9.108	6.07	7.849	2.245	5.37	-1.714	3.643	-5.624	2.499	-11.648
9.156	6.057	7.86	2.245	5.37	-1.699	3.643	-5.631	2.488	-11.654
9.225	6.061	7.847	2.226	5.377	-1.713	3.655	-5.638	2.497	-11.671
9.293	6.057	7.841	2.23	5.348	-1.729	3.664	-5.641	2.49	-11.692
9.328	6.049	7.857	2.224	5.347	-1.72	3.651	-5.658	2.493	-11.691
9.396	6.056	7.834	2.207	5.36	-1.736	3.643	-5.655	2.532	-11.71
9.448	6.042	7.81	2.21	5.345	-1.742	3.66	-5.658	2.528	-11.724

Annex A

9.498	6.042	7.815	2.202	5.362	-1.739	3.658	-5.678	2.516	-11.725
9.556	6.046	7.775	2.188	5.351	-1.759	3.662	-5.673	2.513	-11.75
9.606	6.028	7.782	2.19	5.359	-1.754	3.67	-5.682	2.508	-11.756
9.643	6.031	7.783	2.179	5.348	-1.761	3.662	-5.698	2.515	-11.767
9.693	6.029	7.78	2.174	5.327	-1.782	3.662	-5.691	2.502	-11.789
9.733	6.018	7.802	2.171	5.334	-1.776	3.661	-5.708	2.505	-11.789
9.792	6.019	7.779	2.155	5.321	-1.785	3.646	-5.71	2.492	-11.804
9.848	6.012	7.752	2.156	5.301	-1.801	3.659	-5.713	2.461	-11.831
9.876	6.003	7.774	2.151	5.321	-1.792	3.65	-5.729	2.475	-11.828
9.924	6.011	7.721	2.133	5.305	-1.81	3.634	-5.731	2.486	-11.85
9.96	5.997	7.703	2.133	5.309	-1.817	3.638	-5.735	2.466	-11.864
9.973	5.992	7.682	2.125	5.321	-1.812	3.611	-5.75	2.477	-11.866
9.997	5.995	7.667	2.114	5.282	-1.834	3.615	-5.748	2.459	-11.892
10.034	5.979	7.714	2.117	5.285	-1.828	3.624	-5.757	2.492	-11.895
10.042	5.979	7.67	2.098	5.303	-1.837	3.608	-5.769	2.496	-11.908
10.075	5.975	7.668	2.098	5.282	-1.853	3.618	-5.764	2.444	-11.93
10.1	5.961	7.699	2.099	5.268	-1.844	3.606	-5.779	2.442	-11.934
10.121	5.968	7.665	2.08	5.225	-1.86	3.604	-5.783	2.45	-11.954
10.176	5.959	7.672	2.082	5.193	-1.877	3.62	-5.783	2.452	-11.969
10.197	5.949	7.651	2.074	5.207	-1.87	3.604	-5.801	2.476	-11.967
10.247	5.957	7.65	2.059	5.199	-1.886	3.594	-5.8	2.468	-11.993
10.276	5.943	7.651	2.061	5.195	-1.891	3.607	-5.806	2.445	-12.008
10.303	5.941	7.638	2.05	5.191	-1.891	3.594	-5.822	2.467	-12.006
10.359	5.939	7.632	2.042	5.187	-1.91	3.593	-5.818	2.438	-12.035
10.388	5.924	7.629	2.043	5.184	-1.902	3.582	-5.83	2.454	-12.04
10.427	5.927	7.612	2.028	5.193	-1.916	3.578	-5.837	2.455	-12.049
10.47	5.925	7.595	2.024	5.18	-1.93	3.579	-5.839	2.422	-12.072
10.499	5.91	7.607	2.022	5.176	-1.92	3.561	-5.852	2.443	-12.071
10.535	5.914	7.6	2.008	5.165	-1.937	3.556	-5.856	2.453	-12.094
10.583	5.904	7.613	2.013	5.149	-1.948	3.576	-5.858	2.437	-12.109
10.624	5.899	7.611	2	5.168	-1.943	3.562	-5.874	2.457	-12.109
10.694	5.9	7.597	1.986	5.17	-1.955	3.555	-5.869	2.45	-12.13
10.736	5.888	7.609	1.991	5.159	-1.959	3.56	-5.877	2.441	-12.14
10.772	5.885	7.612	1.978	5.178	-1.961	3.55	-5.893	2.452	-12.144
10.819	5.886	7.595	1.969	5.154	-1.981	3.555	-5.885	2.437	-12.17
10.88	5.868	7.59	1.968	5.15	-1.972	3.563	-5.896	2.43	-12.172
10.909	5.872	7.593	1.953	5.166	-1.981	3.554	-5.908	2.453	-12.19
10.958	5.869	7.59	1.956	5.133	-1.998	3.566	-5.905	2.458	-12.206
11.015	5.856	7.601	1.95	5.151	-1.991	3.563	-5.92	2.464	-12.205
11.031	5.863	7.572	1.933	5.158	-2.01	3.559	-5.919	2.437	-12.23
11.086	5.849	7.573	1.941	5.14	-2.009	3.564	-5.926	2.402	-12.245

Annex A

11.103	5.846	7.579	1.934	5.15	-2.011	3.56	-5.942	2.438	-12.247
11.176	5.85	7.574	1.92	5.14	-2.028	3.56	-5.938	2.436	-12.271
11.184	5.835	7.582	1.922	5.112	-2.031	3.567	-5.947	2.425	-12.278
11.233	5.836	7.572	1.909	5.111	-2.032	3.539	-5.961	2.459	-12.286
11.29	5.836	7.558	1.903	5.1	-2.052	3.546	-5.955	2.464	-12.307
11.302	5.821	7.555	1.903	5.113	-2.045	3.548	-5.97	2.481	-12.309
11.357	5.824	7.526	1.885	5.115	-2.056	3.532	-5.978	2.442	-12.324
11.405	5.817	7.521	1.884	5.116	-2.068	3.529	-5.975	2.421	-12.344
11.449	5.808	7.521	1.878	5.123	-2.061	3.536	-5.993	2.447	-12.35
11.53	5.811	7.503	1.863	5.107	-2.079	3.548	-5.994	2.44	-12.37
11.565	5.801	7.498	1.866	5.096	-2.086	3.543	-5.997	2.442	-12.38
11.606	5.794	7.49	1.853	5.099	-2.082	3.54	-6.011	2.47	-12.384
11.667	5.798	7.472	1.843	5.094	-2.101	3.535	-6.008	2.461	-12.408
11.685	5.779	7.485	1.85	5.091	-2.101	3.524	-6.023	2.454	-12.412
11.718	5.783	7.472	1.832	5.118	-2.109	3.512	-6.034	2.475	-12.42
11.764	5.782	7.453	1.829	5.1	-2.121	3.519	-6.026	2.459	-12.447
11.785	5.765	7.478	1.827	5.108	-2.117	3.513	-6.044	2.472	-12.446
11.832	5.773	7.456	1.812	5.116	-2.132	3.506	-6.051	2.471	-12.466
11.867	5.762	7.465	1.816	5.094	-2.141	3.507	-6.048	2.445	-12.48
11.903	5.754	7.468	1.802	5.093	-2.137	3.506	-6.066	2.457	-12.486
11.952	5.758	7.456	1.789	5.087	-2.154	3.502	-6.067	2.448	-12.507
11.977	5.746	7.444	1.795	5.075	-2.16	3.507	-6.07	2.422	-12.512
12.032	5.74	7.441	1.779	5.084	-2.156	3.473	-6.084	2.418	-12.521
12.07	5.742	7.431	1.772	5.082	-2.172	3.47	-6.08	2.403	-12.545
12.085	5.721	7.446	1.774	5.082	-2.172	3.478	-6.093	2.403	-12.547
12.116	5.725	7.431	1.757	5.077	-2.178	3.453	-6.105	2.411	-12.562
12.138	5.721	7.427	1.755	5.072	-2.195	3.455	-6.102	2.408	-12.585
12.159	5.708	7.443	1.75	5.075	-2.189	3.446	-6.114	2.413	-12.583
12.176	5.712	7.422	1.736	5.077	-2.202	3.425	-6.125	2.417	-12.605
12.224	5.704	7.429	1.743	5.06	-2.21	3.45	-6.123	2.404	-12.618
12.226	5.694	7.447	1.731	5.078	-2.208	3.429	-6.139	2.413	-12.622
12.276	5.697	7.4	1.718	5.054	-2.224	3.433	-6.138	2.421	-12.645
12.281	5.684	7.4	1.724	5.037	-2.233	3.437	-6.146	2.437	-12.651
12.308	5.684	7.379	1.704	5.02	-2.232	3.423	-6.16	2.45	-12.657
12.358	5.683	7.368	1.701	5.021	-2.248	3.431	-6.154	2.423	-12.683
12.356	5.667	7.354	1.698	5.04	-2.249	3.439	-6.166	2.417	-12.683
12.386	5.668	7.329	1.682	5.042	-2.252	3.43	-6.176	2.419	-12.701
12.446	5.661	7.314	1.682	5.044	-2.267	3.426	-6.172	2.413	-12.724
12.455	5.651	7.295	1.674	5.045	-2.261	3.41	-6.191	2.419	-12.723
12.459	5.649	7.282	1.66	5.04	-2.276	3.395	-6.192	2.413	-12.746
12.451	5.64	7.293	1.664	5.027	-2.286	3.4	-6.193	2.412	-12.754

Annex A

12.444	5.634	7.306	1.65	5.049	-2.283	3.387	-6.211	2.442	-12.762
12.452	5.636	7.29	1.646	5.033	-2.3	3.389	-6.209	2.418	-12.786
12.442	5.617	7.306	1.646	5.021	-2.3	3.42	-6.217	2.427	-12.787
12.451	5.619	7.312	1.63	5.04	-2.302	3.412	-6.227	2.444	-12.802
12.484	5.617	7.311	1.632	5.02	-2.317	3.405	-6.225	2.401	-12.825
12.505	5.602	7.303	1.627	5.008	-2.32	3.409	-6.239	2.431	-12.823
12.538	5.605	7.284	1.607	5.011	-2.327	3.404	-6.246	2.439	-12.837
12.564	5.597	7.277	1.613	4.99	-2.337	3.424	-6.242	2.423	-12.858
12.606	5.585	7.27	1.603	5.007	-2.338	3.416	-6.257	2.44	-12.861
12.623	5.588	7.238	1.591	5.016	-2.349	3.413	-6.261	2.41	-12.884
12.642	5.576	7.263	1.593	4.994	-2.353	3.418	-6.261	2.404	-12.889
12.66	5.569	7.256	1.577	5.001	-2.351	3.409	-6.276	2.421	-12.897
12.715	5.574	7.222	1.571	4.992	-2.37	3.394	-6.275	2.399	-12.923
12.713	5.56	7.216	1.572	4.99	-2.37	3.386	-6.283	2.398	-12.924
12.715	5.557	7.214	1.555	4.989	-2.372	3.376	-6.294	2.432	-12.936
12.755	5.555	7.221	1.554	4.966	-2.387	3.4	-6.292	2.396	-12.956
12.761	5.542	7.235	1.552	4.986	-2.387	3.393	-6.306	2.403	-12.959
12.778	5.547	7.22	1.54	4.986	-2.397	3.385	-6.312	2.409	-12.981
12.814	5.537	7.258	1.545	4.975	-2.407	3.383	-6.311	2.402	-12.994
12.834	5.522	7.247	1.531	5.003	-2.403	3.384	-6.328	2.428	-12.994
12.856	5.526	7.225	1.524	5.008	-2.418	3.376	-6.33	2.427	-13.022
12.877	5.518	7.223	1.527	4.988	-2.426	3.381	-6.331	2.427	-13.025
12.9	5.512	7.196	1.503	4.994	-2.426	3.376	-6.348	2.414	-13.036
12.95	5.511	7.174	1.504	4.988	-2.442	3.38	-6.345	2.409	-13.062
12.972	5.495	7.211	1.503	4.984	-2.439	3.367	-6.354	2.424	-13.063
12.992	5.5	7.184	1.485	4.994	-2.443	3.364	-6.364	2.451	-13.08
13.043	5.495	7.174	1.486	4.968	-2.46	3.364	-6.364	2.442	-13.096
13.035	5.477	7.15	1.478	4.965	-2.458	3.349	-6.38	2.43	-13.095
13.056	5.482	7.131	1.467	4.981	-2.466	3.345	-6.385	2.408	-13.119
13.077	5.475	7.148	1.471	4.968	-2.479	3.368	-6.385	2.402	-13.13
13.092	5.467	7.144	1.454	4.965	-2.478	3.356	-6.402	2.413	-13.136
13.122	5.473	7.131	1.451	4.975	-2.49	3.345	-6.401	2.401	-13.161
13.128	5.455	7.144	1.451	4.971	-2.495	3.347	-6.407	2.403	-13.167
13.161	5.457	7.127	1.435	4.985	-2.496	3.328	-6.422	2.404	-13.179
13.184	5.454	7.124	1.432	4.982	-2.511	3.3	-6.42	2.391	-13.199
13.19	5.441	7.15	1.428	4.987	-2.513	3.31	-6.428	2.433	-13.197
13.223	5.444	7.146	1.409	4.992	-2.517	3.304	-6.44	2.469	-13.216
13.257	5.434	7.156	1.419	4.965	-2.531	3.314	-6.435	2.438	-13.235
13.277	5.421	7.142	1.407	4.969	-2.53	3.313	-6.453	2.431	-13.235
13.304	5.428	7.117	1.393	4.958	-2.54	3.308	-6.455	2.421	-13.26
13.331	5.416	7.134	1.397	4.951	-2.548	3.305	-6.454	2.429	-13.269

Annex A

13.336	5.405	7.115	1.381	4.949	-2.548	3.292	-6.476	2.445	-13.273
13.388	5.413	7.111	1.379	4.954	-2.563	3.282	-6.473	2.418	-13.297
13.419	5.398	7.143	1.378	4.945	-2.568	3.291	-6.477	2.419	-13.295
13.429	5.396	7.115	1.358	4.934	-2.566	3.281	-6.495	2.417	-13.315
13.48	5.393	7.118	1.367	4.927	-2.586	3.299	-6.493	2.391	-13.336
13.509	5.379	7.095	1.357	4.918	-2.586	3.306	-6.505	2.404	-13.337
13.542	5.384	7.087	1.337	4.902	-2.593	3.3	-6.51	2.401	-13.359
13.595	5.377	7.092	1.346	4.893	-2.606	3.315	-6.509	2.398	-13.37
13.617	5.365	7.092	1.333	4.893	-2.607	3.307	-6.524	2.415	-13.373
13.648	5.373	7.073	1.324	4.907	-2.618	3.308	-6.527	2.417	-13.397
13.689	5.359	7.073	1.325	4.908	-2.623	3.33	-6.527	2.394	-13.406
13.707	5.352	7.049	1.303	4.911	-2.623	3.325	-6.547	2.422	-13.414
13.756	5.354	7.042	1.305	4.881	-2.637	3.309	-6.542	2.415	-13.439
13.784	5.34	7.056	1.307	4.842	-2.643	3.308	-6.549	2.421	-13.438
13.815	5.343	7.051	1.284	4.871	-2.644	3.288	-6.564	2.431	-13.456
13.843	5.338	7.075	1.291	4.875	-2.661	3.298	-6.559	2.411	-13.474
13.837	5.321	7.083	1.279	4.856	-2.657	3.289	-6.576	2.395	-13.471
13.864	5.328	7.054	1.268	4.855	-2.666	3.285	-6.579	2.4	-13.497
13.903	5.322	7.09	1.275	4.834	-2.681	3.279	-6.58	2.404	-13.509
13.913	5.308	7.076	1.257	4.833	-2.679	3.261	-6.599	2.423	-13.51
13.931	5.317	7.085	1.252	4.837	-2.69	3.262	-6.598	2.417	-13.537
13.95	5.301	7.062	1.256	4.816	-2.697	3.278	-6.603	2.421	-13.542
13.963	5.298	7.017	1.23	4.822	-2.7	3.267	-6.617	2.413	-13.555
13.99	5.297	7.024	1.234	4.805	-2.713	3.267	-6.615	2.377	-13.575
13.989	5.281	7.017	1.231	4.788	-2.713	3.277	-6.621	2.366	-13.579
13.979	5.283	7.012	1.211	4.835	-2.717	3.274	-6.635	2.378	-13.6
13.993	5.281	7.038	1.22	4.815	-2.735	3.284	-6.63	2.36	-13.612
13.984	5.265	7.049	1.205	4.816	-2.73	3.283	-6.641	2.378	-13.615
13.99	5.27	7.027	1.195	4.789	-2.738	3.277	-6.649	2.344	-13.641
14	5.261	7.041	1.202	4.797	-2.75	3.287	-6.648	2.353	-13.646
13.979	5.249	7.052	1.183	4.793	-2.749	3.293	-6.665	2.392	-13.651
14.007	5.255	7.044	1.181	4.81	-2.76	3.289	-6.662	2.389	-13.677
14.009	5.238	7.073	1.18	4.823	-2.761	3.287	-6.67	2.413	-13.679
14.024	5.235	7.017	1.162	4.794	-2.766	3.26	-6.688	2.436	-13.69
14.052	5.236	7.012	1.168	4.799	-2.783	3.26	-6.681	2.447	-13.709
14.077	5.222	7.048	1.16	4.75	-2.782	3.275	-6.689	2.488	-13.706
14.077	5.224	7.006	1.145	4.77	-2.788	3.261	-6.703	2.507	-13.729
14.105	5.214	7.029	1.154	4.765	-2.803	3.294	-6.7	2.473	-13.742
14.092	5.203	7.002	1.135	4.743	-2.804	3.292	-6.711	2.503	-13.744
14.117	5.207	6.98	1.126	4.738	-2.812	3.277	-6.717	2.524	-13.768
14.143	5.195	6.991	1.134	4.743	-2.819	3.284	-6.717	2.521	-13.777

Annex A

14.147	5.185	6.966	1.113	4.753	-2.819	3.278	-6.735	2.516	-13.781
14.151	5.191	6.98	1.115	4.733	-2.836	3.277	-6.733	2.43	-13.81
14.146	5.172	7.003	1.111	4.719	-2.837	3.285	-6.736	2.471	-13.813
14.147	5.17	6.979	1.092	4.739	-2.839	3.265	-6.756	2.48	-13.83
14.155	5.169	6.984	1.098	4.742	-2.856	3.254	-6.75	2.455	-13.844
14.153	5.155	7.027	1.087	4.746	-2.852	3.257	-6.765	2.465	-13.847
14.172	5.158	6.99	1.071	4.747	-2.862	3.245	-6.774	2.456	-13.868
14.198	5.15	6.98	1.08	4.727	-2.877	3.268	-6.77	2.433	-13.882
14.197	5.138	6.994	1.068	4.717	-2.873	3.257	-6.786	2.448	-13.882
14.22	5.144	6.964	1.056	4.722	-2.886	3.235	-6.791	2.415	-13.91
14.235	5.126	6.987	1.059	4.685	-2.894	3.246	-6.792	2.39	-13.916
14.237	5.119	6.969	1.039	4.681	-2.895	3.218	-6.808	2.419	-13.926
14.241	5.121	6.953	1.041	4.666	-2.91	3.228	-6.804	2.443	-13.949
14.245	5.107	6.975	1.036	4.671	-2.909	3.238	-6.812	2.461	-13.948
14.225	5.105	6.941	1.019	4.668	-2.917	3.215	-6.826	2.474	-13.964
14.211	5.099	6.953	1.026	4.666	-2.93	3.235	-6.822	2.468	-13.98
14.167	5.083	6.968	1.013	4.667	-2.925	3.235	-6.834	2.493	-13.981
14.159	5.089	6.935	1.004	4.674	-2.937	3.221	-6.847	2.488	-14.006
14.16	5.077	6.94	1.009	4.658	-2.951	3.232	-6.845	2.471	-14.016
14.145	5.067	6.924	0.99	4.667	-2.945	3.224	-6.854	2.455	-14.023
14.162	5.073	6.92	0.986	4.66	-2.959	3.212	-6.86	2.432	-14.048
14.166	5.06	6.93	0.987	4.668	-2.966	3.22	-6.862	2.426	-14.048
14.147	5.055	6.903	0.97	4.674	-2.968	3.202	-6.879	2.408	-14.062
14.179	5.054	6.935	0.969	4.678	-2.982	3.209	-6.874	2.387	-14.085
14.168	5.037	6.944	0.97	4.671	-2.98	3.214	-6.885	2.403	-14.083
14.171	5.04	6.906	0.947	4.671	-2.99	3.195	-6.897	2.399	-14.11
14.177	5.033	6.919	0.954	4.647	-3.005	3.207	-6.892	2.42	-14.116
14.176	5.019	6.929	0.941	4.636	-3	3.217	-6.904	2.418	-14.12
14.18	5.021	6.903	0.932	4.638	-3.01	3.213	-6.914	2.366	-14.15
14.166	5.009	6.925	0.936	4.629	-3.022	3.225	-6.913	2.32	-14.156
14.144	5	6.883	0.918	4.638	-3.02	3.2	-6.929	2.326	-14.168
14.166	5.004	6.881	0.914	4.632	-3.033	3.199	-6.927	2.28	-14.194
14.152	4.985	6.882	0.912	4.619	-3.038	3.219	-6.936	2.3	-14.194
14.158	4.984	6.855	0.898	4.653	-3.041	3.2	-6.951	2.35	-14.209
14.139	4.985	6.85	0.898	4.617	-3.056	3.216	-6.946	2.368	-14.226
14.13	4.968	6.868	0.889	4.588	-3.054	3.21	-6.954	2.375	-14.225
14.123	4.969	6.836	0.873	4.58	-3.062	3.202	-6.97	2.353	-14.246
14.107	4.96	6.852	0.882	4.57	-3.081	3.213	-6.964	2.34	-14.262
14.12	4.95	6.86	0.865	4.571	-3.074	3.209	-6.981	2.375	-14.264
14.131	4.95	6.824	0.855	4.583	-3.085	3.192	-6.983	2.329	-14.292
14.112	4.937	6.845	0.86	4.563	-3.095	3.197	-6.981	2.319	-14.294

Annex A

14.093	4.927	6.831	0.845	4.557	-3.093	3.205	-7.001	2.34	-14.307
14.097	4.932	6.811	0.839	4.565	-3.109	3.206	-7	2.327	-14.331
14.087	4.912	6.8	0.84	4.574	-3.113	3.226	-7.002	2.312	-14.328
14.056	4.911	6.802	0.823	4.595	-3.115	3.192	-7.02	2.309	-14.351
14.049	4.91	6.798	0.828	4.58	-3.127	3.194	-7.015	2.307	-14.367
14.042	4.895	6.822	0.816	4.581	-3.127	3.192	-7.029	2.333	-14.368
14.039	4.894	6.795	0.803	4.589	-3.132	3.176	-7.036	2.333	-14.389
14.022	4.884	6.805	0.808	4.58	-3.144	3.191	-7.03	2.325	-14.399
14.008	4.874	6.812	0.795	4.586	-3.142	3.188	-7.05	2.34	-14.407
14.008	4.88	6.787	0.783	4.566	-3.157	3.191	-7.052	2.337	-14.428
13.978	4.862	6.789	0.788	4.543	-3.163	3.211	-7.053	2.371	-14.427
13.958	4.855	6.781	0.77	4.544	-3.165	3.194	-7.067	2.377	-14.442
13.948	4.858	6.776	0.77	4.538	-3.18	3.19	-7.067	2.327	-14.464
13.94	4.837	6.773	0.765	4.542	-3.179	3.201	-7.075	2.336	-14.465
13.938	4.839	6.768	0.751	4.535	-3.186	3.167	-7.089	2.329	-14.484
13.953	4.834	6.775	0.755	4.523	-3.198	3.204	-7.081	2.312	-14.499
13.952	4.816	6.78	0.745	4.519	-3.196	3.2	-7.095	2.336	-14.501
13.958	4.823	6.749	0.734	4.536	-3.208	3.198	-7.105	2.304	-14.528
13.963	4.814	6.756	0.739	4.511	-3.218	3.212	-7.1	2.28	-14.535
13.964	4.804	6.745	0.72	4.532	-3.214	3.192	-7.122	2.292	-14.545
13.983	4.803	6.725	0.714	4.506	-3.228	3.188	-7.123	2.282	-14.573
13.971	4.791	6.72	0.717	4.496	-3.235	3.202	-7.121	2.305	-14.57
13.966	4.787	6.721	0.7	4.493	-3.234	3.182	-7.14	2.305	-14.586
13.997	4.788	6.723	0.697	4.487	-3.253	3.2	-7.134	2.296	-14.603
14.007	4.769	6.73	0.695	4.472	-3.252	3.207	-7.147	2.309	-14.604
14.027	4.771	6.691	0.681	4.475	-3.258	3.191	-7.161	2.323	-14.625
14.016	4.769	6.703	0.683	4.455	-3.275	3.2	-7.153	2.301	-14.643
14.014	4.753	6.695	0.668	4.437	-3.272	3.201	-7.168	2.324	-14.639
14.002	4.752	6.676	0.659	4.439	-3.284	3.185	-7.178	2.315	-14.667
13.974	4.739	6.668	0.664	4.424	-3.293	3.18	-7.17	2.322	-14.669
13.956	4.732	6.663	0.647	4.417	-3.292	3.174	-7.195	2.314	-14.68
13.939	4.735	6.656	0.638	4.42	-3.306	3.173	-7.192	2.304	-14.705
13.927	4.716	6.669	0.644	4.402	-3.31	3.163	-7.197	2.313	-14.702
13.927	4.719	6.66	0.624	4.402	-3.315	3.149	-7.216	2.306	-14.726
13.911	4.713	6.656	0.626	4.405	-3.329	3.172	-7.208	2.309	-14.742
13.883	4.695	6.655	0.62	4.401	-3.329	3.163	-7.221	2.321	-14.739
13.87	4.697	6.639	0.603	4.399	-3.335	3.161	-7.232	2.311	-14.765
13.847	4.689	6.635	0.609	4.393	-3.349	3.183	-7.224	2.266	-14.775
13.821	4.679	6.636	0.595	4.404	-3.345	3.189	-7.24	2.286	-14.782
13.842	4.682	6.612	0.585	4.374	-3.363	3.192	-7.244	2.257	-14.808
13.816	4.665	6.633	0.587	4.357	-3.366	3.199	-7.239	2.246	-14.813

Annex A

13.803	4.664	6.654	0.575	4.368	-3.366	3.182	-7.263	2.264	-14.827
13.786	4.664	6.617	0.569	4.356	-3.382	3.168	-7.262	2.267	-14.846
13.767	4.64	6.623	0.57	4.355	-3.385	3.204	-7.262	2.286	-14.841
13.702	4.646	6.615	0.551	4.354	-3.388	3.175	-7.282	2.311	-14.864
13.7	4.64	6.623	0.553	4.325	-3.403	3.202	-7.278	2.301	-14.877
13.673	4.62	6.622	0.547	4.336	-3.404	3.205	-7.291	2.297	-14.876
13.653	4.625	6.604	0.534	4.342	-3.411	3.185	-7.298	2.287	-14.901
13.658	4.614	6.604	0.531	4.341	-3.42	3.163	-7.298	2.29	-14.912
13.611	4.603	6.595	0.522	4.357	-3.419	3.086	-7.312	2.306	-14.918
13.621	4.606	6.576	0.513	4.365	-3.434	3.247	-7.303	2.28	-14.943
13.599	4.591	6.602	0.516	4.338	-3.442	3.163	-7.321	2.309	-14.941
13.572	4.588	6.601	0.497	4.357	-3.439	3.122	-7.346	2.312	-14.956
13.576	4.585	6.584	0.497	4.351	-3.453	3.122	-7.345	2.305	-14.981
13.523	4.566	6.592	0.496	4.335	-3.456	3.117	-7.366	2.318	-14.976
13.48	4.571	6.573	0.476	4.34	-3.461	3.105	-7.381	2.33	-15.001
13.481	4.558	6.575	0.479	4.336	-3.474	3.122	-7.383	2.307	-15.014
13.435	4.544	6.577	0.473	4.344	-3.473	3.105	-7.41	2.347	-15.013
13.414	4.549	6.562	0.461	4.349	-3.483	3.103	-7.417	2.34	-15.042
13.383	4.534	6.58	0.464	4.343	-3.492	3.117	-7.423	2.337	-15.045
13.349	4.529	6.579	0.45	4.35	-3.491	3.107	-7.447	2.348	-15.053
13.344	4.529	6.584	0.444	4.337	-3.506	3.108	-7.449	2.311	-15.081
13.311	4.51	6.585	0.443	4.313	-3.51	3.11	-7.46	2.292	-15.084
13.283	4.512	6.593	0.431	4.339	-3.509	3.088	-7.485	2.31	-15.099
13.281	4.504	6.587	0.427	4.341	-3.522	3.099	-7.481	2.314	-15.118
13.251	4.487	6.579	0.424	4.349	-3.524	3.083	-7.506	2.339	-15.115
13.254	4.494	6.579	0.407	4.348	-3.528	3.058	-7.521	2.341	-15.142
13.233	4.485	6.551	0.408	4.354	-3.543	3.077	-7.521	2.332	-15.152
13.225	4.471	6.554	0.401	4.357	-3.54	3.069	-7.549	2.36	-15.151
13.224	4.475	6.533	0.387	4.355	-3.554	3.049	-7.557	2.361	-15.183
13.209	4.457	6.552	0.391	4.37	-3.557	3.076	-7.568	2.377	-15.181
13.197	4.452	6.55	0.378	4.368	-3.557	3.058	-7.591	2.38	-15.193
13.195	4.453	6.533	0.374	4.354	-3.574	3.062	-7.587	2.36	-15.214
13.162	4.433	6.553	0.375	4.313	-3.575	3.096	-7.605	2.374	-15.214
13.139	4.438	6.529	0.358	4.348	-3.578	3.083	-7.628	2.378	-15.235
13.147	4.429	6.511	0.357	4.332	-3.594	3.092	-7.628	2.344	-15.248
13.099	4.412	6.51	0.355	4.324	-3.595	3.085	-7.649	2.339	-15.249
13.093	4.418	6.515	0.339	4.328	-3.602	3.073	-7.663	2.34	-15.273
13.072	4.403	6.51	0.341	4.327	-3.614	3.093	-7.666	2.339	-15.28
13.043	4.394	6.479	0.329	4.341	-3.611	3.055	-7.696	2.382	-15.283
13.04	4.399	6.474	0.319	4.325	-3.626	3.038	-7.695	2.363	-15.308
13.023	4.38	6.501	0.321	4.301	-3.632	3.067	-7.709	2.349	-15.317

Annex A

12.994	4.378	6.48	0.305	4.305	-3.631	3.054	-7.736	2.323	-15.33
13.002	4.376	6.461	0.302	4.303	-3.648	3.07	-7.732	2.32	-15.348
12.951	4.355	6.466	0.3	4.299	-3.65	3.068	-7.748	2.274	-15.341
12.924	4.362	6.471	0.286	4.316	-3.65	3.039	-7.773	2.255	-15.352
12.909	4.349	6.468	0.288	4.31	-3.667	3.055	-7.772	2.248	-15.352
12.89	4.336	6.488	0.281	4.289	-3.666	3.049	-7.795		
12.864	4.344	6.458	0.263	4.323	-3.675	3.058	-7.808		
12.844	4.323	6.481	0.271	4.298	-3.687	3.091	-7.808		

Table 11. Tensile Trial 5 Results.

F (Kg)	D (mm)	F (Kg)	D (mm)	F (Kg)	D (mm)	F (Kg)	D (mm)	F (Kg)	D (mm)
-1.214	10.503	2.526	7.342	2.121	3.047	2.013	-1.258	1.998	-5.551
-1.221	10.501	2.517	7.322	2.129	3.032	1.997	-1.267	2.006	-5.54
-1.228	10.502	2.514	7.327	2.118	3.019	2.026	-1.262	2.014	-5.553
-1.22	10.502	2.52	7.322	2.138	3.031	2.042	-1.276	1.976	-5.571
-1.229	10.496	2.51	7.304	2.151	3.014	2.038	-1.286	1.974	-5.558
-1.229	10.504	2.498	7.307	2.149	3.005	2.056	-1.283	1.968	-5.574
-1.221	10.505	2.485	7.296	2.208	3.01	2.067	-1.298	1.939	-5.588
-1.231	10.497	2.48	7.287	2.212	2.985	2.063	-1.303	1.92	-5.58
-1.225	10.501	2.499	7.289	2.205	2.991	2.082	-1.306	1.901	-5.598
-1.218	10.503	2.493	7.271	2.23	2.99	2.084	-1.32	1.871	-5.605
-1.229	10.5	2.477	7.269	2.202	2.966	2.086	-1.317	1.87	-5.603
-1.228	10.503	2.479	7.269	2.229	2.977	2.089	-1.324	1.844	-5.626
-1.222	10.499	2.471	7.25	2.25	2.969	2.079	-1.343	1.839	-5.621
-1.229	10.5	2.448	7.251	2.232	2.952	2.075	-1.336	1.867	-5.624
-1.22	10.505	2.457	7.246	2.263	2.96	2.07	-1.348	1.85	-5.643
-1.223	10.497	2.43	7.23	2.273	2.947	2.041	-1.357	1.867	-5.632
-1.233	10.501	2.418	7.232	2.266	2.938	2.06	-1.354	1.891	-5.647
-1.223	10.505	2.387	7.221	2.274	2.94	2.049	-1.372	1.875	-5.658
-1.218	10.498	2.356	7.213	2.267	2.922	2.043	-1.377	1.899	-5.651
-1.225	10.5	2.36	7.214	2.257	2.92	2.041	-1.376	1.898	-5.671
-1.221	10.502	2.344	7.197	2.285	2.923	2.009	-1.392	1.9	-5.676
-1.231	10.5	2.327	7.191	2.258	2.897	1.984	-1.395	1.902	-5.669
-1.215	10.504	2.329	7.193	2.253	2.905	1.981	-1.399	1.896	-5.69
-1.218	10.5	2.314	7.172	2.278	2.894	1.945	-1.416	1.893	-5.692
-1.235	10.5	2.3	7.174	2.258	2.88	1.935	-1.411	1.894	-5.694
-1.219	10.505	2.316	7.171	2.263	2.888	1.942	-1.425	1.872	-5.717
-1.215	10.5	2.297	7.154	2.242	2.874	1.927	-1.437	1.866	-5.705
-1.228	10.499	2.314	7.156	2.234	2.864	1.921	-1.43	1.871	-5.717

Annex A

-1.22	10.504	2.324	7.149	2.243	2.869	1.922	-1.444	1.851	-5.735
-1.223	10.499	2.309	7.133	2.228	2.852	1.907	-1.455	1.85	-5.725
-1.232	10.502	2.326	7.139	2.222	2.847	1.896	-1.453	1.854	-5.735
-1.221	10.504	2.327	7.127	2.25	2.85	1.903	-1.469	1.831	-5.749
-1.23	10.498	2.312	7.119	2.249	2.827	1.88	-1.469	1.849	-5.746
-1.22	10.503	2.315	7.12	2.243	2.835	1.884	-1.475	1.825	-5.763
-1.219	10.501	2.292	7.103	2.259	2.829	1.856	-1.491	1.811	-5.766
-1.234	10.498	2.292	7.099	2.242	2.807	1.855	-1.486	1.838	-5.766
-1.217	10.503	2.319	7.099	2.228	2.814	1.862	-1.497	1.828	-5.786
-1.221	10.5	2.319	7.082	2.229	2.804	1.834	-1.513	1.833	-5.782
-1.23	10.499	2.343	7.084	2.208	2.791	1.841	-1.508	1.848	-5.786
-1.226	10.504	2.364	7.075	2.216	2.792	1.845	-1.518	1.831	-5.806
-1.22	10.499	2.364	7.065	2.199	2.778	1.835	-1.531	1.842	-5.799
-1.226	10.501	2.386	7.07	2.174	2.774	1.849	-1.526	1.849	-5.811
-1.225	10.505	2.396	7.056	2.197	2.778	1.855	-1.541	1.852	-5.824
-1.221	10.5	2.403	7.047	2.189	2.755	1.867	-1.542	1.872	-5.817
-1.225	10.503	2.42	7.052	2.196	2.754	1.888	-1.545	1.881	-5.832
-1.222	10.501	2.432	7.034	2.207	2.756	1.888	-1.559	1.895	-5.837
-1.231	10.498	2.44	7.029	2.189	2.737	1.897	-1.558	1.921	-5.835
-1.223	10.505	2.449	7.028	2.183	2.74	1.929	-1.56	1.915	-5.855
-1.22	10.502	2.438	7.016	2.161	2.73	1.928	-1.576	1.931	-5.852
-1.23	10.497	2.435	7.017	2.12	2.716	1.927	-1.573	1.954	-5.853
-1.221	10.505	2.438	7.01	2.113	2.723	1.949	-1.581	1.953	-5.872
-1.229	10.501	2.411	6.999	2.119	2.705	1.968	-1.589	1.949	-5.869
-1.225	10.499	2.414	7.001	2.11	2.697	1.983	-1.589	1.96	-5.873
-1.22	10.503	2.402	6.989	2.127	2.704	1.98	-1.6	1.934	-5.888
-1.225	10.499	2.366	6.977	2.143	2.687	1.984	-1.605	1.939	-5.882
-1.232	10.503	2.365	6.981	2.142	2.682	1.99	-1.607	1.94	-5.895
-1.218	10.504	2.365	6.969	2.182	2.688	1.978	-1.621	1.915	-5.905
-1.225	10.496	2.369	6.961	2.177	2.669	1.973	-1.621	1.929	-5.901
-1.224	10.503	2.393	6.961	2.179	2.669	1.983	-1.625	1.925	-5.914
-1.219	10.503	2.381	6.946	2.202	2.663	1.962	-1.645	1.92	-5.92
-1.225	10.498	2.393	6.947	2.187	2.651	1.961	-1.639	1.944	-5.919
-1.223	10.502	2.406	6.939	2.218	2.654	1.962	-1.647	1.928	-5.939
-1.223	10.502	2.375	6.924	2.229	2.643	1.94	-1.664	1.931	-5.94
-1.234	10.5	2.384	6.93	2.214	2.63	1.927	-1.659	1.945	-5.941
-1.214	10.504	2.385	6.918	2.224	2.637	1.934	-1.671	1.935	-5.958
-1.213	10.498	2.371	6.905	2.234	2.62	1.922	-1.678	1.932	-5.955
-1.217	10.502	2.368	6.911	2.207	2.614	1.946	-1.678	1.931	-5.963
-1.211	10.508	2.379	6.896	2.217	2.618	1.929	-1.695	1.929	-5.978
-1.103	10.501	2.37	6.89	2.208	2.598	1.933	-1.696	1.942	-5.972

Annex A

-1.079	10.491	2.396	6.891	2.196	2.595	1.964	-1.698	1.948	-5.991
-1.02	10.507	2.373	6.874	2.201	2.596	1.952	-1.715	1.939	-5.993
-0.967	10.501	2.37	6.872	2.178	2.575	1.973	-1.714	1.963	-5.988
-0.949	10.493	2.376	6.869	2.171	2.579	1.994	-1.717	1.961	-6.006
-0.902	10.506	2.352	6.853	2.182	2.57	2.008	-1.732	1.963	-6.011
-0.862	10.498	2.357	6.857	2.154	2.556	2.03	-1.73	1.973	-6.01
-0.833	10.5	2.37	6.849	2.155	2.561	2.043	-1.739	1.964	-6.027
-0.783	10.506	2.359	6.834	2.135	2.547	2.039	-1.746	1.961	-6.028
-0.738	10.497	2.366	6.84	2.115	2.536	2.056	-1.745	1.957	-6.033
-0.693	10.503	2.366	6.825	2.109	2.544	2.058	-1.762	1.934	-6.047
-0.627	10.505	2.353	6.817	2.107	2.528	2.055	-1.765	1.939	-6.044
-0.595	10.494	2.358	6.816	2.09	2.519	2.062	-1.765	1.917	-6.062
-0.546	10.503	2.338	6.802	2.1	2.519	2.046	-1.786	1.907	-6.071
-0.45	10.504	2.334	6.802	2.087	2.504	2.023	-1.785	1.907	-6.062
-0.407	10.494	2.361	6.797	2.099	2.506	2.025	-1.788	1.901	-6.078
-0.355	10.506	2.365	6.78	2.121	2.499	2.009	-1.802	1.909	-6.085
-0.305	10.5	2.366	6.785	2.104	2.484	2.003	-1.8	1.935	-6.081
-0.296	10.497	2.388	6.779	2.121	2.49	1.994	-1.812	1.943	-6.097
-0.265	10.506	2.384	6.762	2.127	2.48	1.95	-1.822	1.954	-6.099
-0.233	10.498	2.395	6.771	2.13	2.463	1.956	-1.821	1.979	-6.101
-0.204	10.502	2.394	6.758	2.143	2.47	1.95	-1.834	1.968	-6.116
-0.156	10.504	2.388	6.746	2.151	2.46	1.945	-1.842	1.992	-6.113
-0.144	10.497	2.405	6.748	2.139	2.451	1.946	-1.838	1.998	-6.123
-0.137	10.503	2.403	6.735	2.163	2.45	1.947	-1.86	1.981	-6.138
-0.111	10.505	2.407	6.732	2.146	2.432	1.939	-1.86	1.968	-6.131
-0.122	10.491	2.419	6.732	2.148	2.434	1.957	-1.863	1.963	-6.149
-0.112	10.504	2.406	6.714	2.166	2.433	1.957	-1.876	1.945	-6.156
-0.087	10.504	2.397	6.714	2.153	2.412	1.965	-1.878	1.948	-6.15
-0.079	10.496	2.423	6.712	2.153	2.418	1.977	-1.881	1.948	-6.167
-0.045	10.506	2.396	6.695	2.153	2.413	1.973	-1.896	1.934	-6.172
-0.022	10.502	2.396	6.696	2.126	2.395	1.993	-1.892	1.944	-6.172
-0.003	10.496	2.366	6.689	2.135	2.397	1.997	-1.906	1.924	-6.187
0.033	10.506	2.339	6.678	2.13	2.385	1.987	-1.911	1.941	-6.185
0.054	10.498	2.337	6.68	2.124	2.378	2.004	-1.91	1.962	-6.192
0.063	10.5	2.329	6.661	2.134	2.381	2.006	-1.927	1.964	-6.207
0.082	10.506	2.307	6.658	2.129	2.367	1.996	-1.927	1.993	-6.201
0.082	10.495	2.32	6.659	2.128	2.358	2.004	-1.931	1.994	-6.215
0.095	10.5	2.304	6.641	2.149	2.36	1.989	-1.949	1.98	-6.226
0.131	10.504	2.298	6.64	2.138	2.341	1.975	-1.945	1.984	-6.219
0.137	10.496	2.312	6.635	2.129	2.345	1.979	-1.952	1.981	-6.235
0.161	10.503	2.297	6.625	2.135	2.341	1.976	-1.964	1.963	-6.242

Annex A

0.19	10.5	2.311	6.627	2.123	2.324	2	-1.958	1.979	-6.24
0.187	10.496	2.322	6.619	2.149	2.331	2.014	-1.969	1.942	-6.256
0.213	10.506	2.3	6.609	2.174	2.32	2.014	-1.979	1.942	-6.256
0.221	10.496	2.314	6.613	2.176	2.31	2.03	-1.974	1.946	-6.26
0.231	10.495	2.293	6.595	2.203	2.313	2.024	-1.988	1.926	-6.272
0.259	10.504	2.289	6.59	2.22	2.301	2.029	-1.997	1.933	-6.271
0.257	10.498	2.275	6.591	2.225	2.296	2.039	-1.993	1.933	-6.279
0.248	10.498	2.261	6.57	2.262	2.298	2.04	-2.008	1.908	-6.298
0.255	10.5	2.245	6.572	2.261	2.278	2.044	-2.01	1.916	-6.291
0.244	10.495	2.237	6.566	2.264	2.28	2.05	-2.015	1.912	-6.302
0.252	10.502	2.202	6.549	2.299	2.281	2.039	-2.031	1.9	-6.311
0.271	10.501	2.205	6.549	2.278	2.261	2.044	-2.024	1.915	-6.312
0.269	10.493	2.19	6.543	2.29	2.264	2.043	-2.037	1.898	-6.329
0.291	10.506	2.174	6.527	2.311	2.255	2.019	-2.049	1.891	-6.328
0.311	10.498	2.193	6.534	2.304	2.244	2.033	-2.043	1.892	-6.334
0.332	10.494	2.204	6.519	2.311	2.247	2.058	-2.058	1.864	-6.351
0.368	10.503	2.203	6.513	2.309	2.232	2.043	-2.066	1.859	-6.345
0.393	10.498	2.256	6.516	2.291	2.229	2.041	-2.064	1.87	-6.352
0.403	10.496	2.257	6.495	2.297	2.231	2.031	-2.082	1.846	-6.369
0.43	10.502	2.261	6.498	2.283	2.21	2.022	-2.083	1.852	-6.363
0.456	10.494	2.286	6.495	2.254	2.208	2.022	-2.085	1.864	-6.378
0.47	10.499	2.284	6.477	2.251	2.211	2.008	-2.105	1.844	-6.387
0.507	10.5	2.292	6.481	2.229	2.187	2.006	-2.097	1.852	-6.384
0.505	10.492	2.296	6.471	2.225	2.188	2.002	-2.11	1.846	-6.4
0.546	10.501	2.273	6.458	2.222	2.186	1.984	-2.124	1.837	-6.402
0.571	10.499	2.284	6.461	2.186	2.167	1.98	-2.117	1.854	-6.409
0.581	10.493	2.263	6.449	2.183	2.172	1.984	-2.133	1.851	-6.423
0.614	10.5	2.256	6.441	2.176	2.159	1.973	-2.142	1.853	-6.42
0.65	10.495	2.28	6.444	2.146	2.15	1.983	-2.136	1.885	-6.424
0.676	10.492	2.283	6.426	2.154	2.154	1.975	-2.153	1.873	-6.443
0.739	10.5	2.28	6.425	2.138	2.135	1.963	-2.157	1.879	-6.437
0.767	10.493	2.292	6.425	2.124	2.127	1.966	-2.16	1.885	-6.443
0.808	10.494	2.258	6.408	2.14	2.127	1.922	-2.176	1.881	-6.457
0.871	10.497	2.276	6.411	2.113	2.112	1.902	-2.172	1.873	-6.454
0.933	10.49	2.275	6.395	2.106	2.109	1.912	-2.184	1.88	-6.47
1.003	10.496	2.249	6.386	2.113	2.105	1.878	-2.198	1.888	-6.471
1.106	10.496	2.267	6.392	2.086	2.089	1.87	-2.192	1.912	-6.472
1.163	10.484	2.26	6.374	2.084	2.092	1.875	-2.211	1.902	-6.491
1.222	10.496	2.239	6.366	2.087	2.08	1.867	-2.221	1.886	-6.49
1.29	10.492	2.24	6.373	2.07	2.069	1.887	-2.214	1.904	-6.494
1.338	10.483	2.229	6.353	2.058	2.073	1.885	-2.232	1.877	-6.511

Annex A

1.4	10.492	2.218	6.349	2.056	2.055	1.878	-2.235	1.888	-6.509
1.438	10.484	2.244	6.347	2.041	2.05	1.903	-2.234	1.9	-6.515
1.48	10.489	2.22	6.331	2.05	2.052	1.901	-2.252	1.888	-6.529
1.544	10.489	2.226	6.337	2.032	2.034	1.924	-2.247	1.889	-6.525
1.597	10.478	2.214	6.328	2.027	2.033	1.943	-2.255	1.875	-6.539
1.651	10.485	2.188	6.311	2.028	2.032	1.938	-2.273	1.858	-6.544
1.725	10.488	2.185	6.319	2.012	2.015	1.951	-2.261	1.877	-6.546
1.766	10.476	2.183	6.301	2.025	2.019	1.957	-2.274	1.881	-6.559
1.825	10.48	2.14	6.293	2.043	2.008	1.942	-2.29	1.894	-6.561
1.877	10.482	2.154	6.297	2.015	1.995	1.967	-2.281	1.91	-6.563
1.924	10.475	2.142	6.282	2.031	2.001	1.971	-2.298	1.894	-6.581
1.979	10.482	2.145	6.277	2.037	1.984	1.977	-2.304	1.893	-6.581
2.016	10.474	2.162	6.275	2.034	1.977	2.01	-2.301	1.916	-6.585
2.062	10.474	2.128	6.255	2.046	1.979	2.006	-2.32	1.901	-6.599
2.13	10.48	2.139	6.261	2.051	1.97	2.003	-2.316	1.915	-6.597
2.172	10.469	2.156	6.254	2.079	1.962	2.031	-2.319	1.907	-6.609
2.216	10.473	2.133	6.238	2.098	1.96	2.006	-2.341	1.895	-6.617
2.285	10.475	2.154	6.248	2.086	1.949	2.018	-2.333	1.916	-6.612
2.331	10.464	2.155	6.235	2.115	1.949	2.031	-2.345	1.929	-6.629
2.451	10.471	2.142	6.225	2.125	1.944	2.019	-2.356	1.925	-6.633
2.561	10.467	2.169	6.231	2.124	1.934	2.049	-2.347	1.944	-6.63
2.636	10.461	2.165	6.214	2.141	1.939	2.057	-2.365	1.936	-6.646
2.726	10.469	2.175	6.21	2.164	1.926	2.048	-2.372	1.913	-6.647
2.791	10.457	2.208	6.212	2.151	1.912	2.064	-2.364	1.937	-6.649
2.844	10.452	2.186	6.194	2.168	1.919	2.059	-2.389	1.937	-6.661
2.913	10.461	2.193	6.198	2.159	1.902	2.056	-2.385	1.943	-6.662
2.967	10.45	2.189	6.189	2.159	1.901	2.083	-2.385	1.942	-6.671
3.016	10.448	2.151	6.171	2.167	1.899	2.057	-2.409	1.923	-6.685
3.093	10.452	2.166	6.181	2.151	1.883	2.045	-2.401	1.944	-6.684
3.123	10.436	2.173	6.165	2.149	1.884	2.063	-2.409	1.937	-6.697
3.175	10.442	2.157	6.153	2.16	1.878	2.038	-2.425	1.926	-6.703
3.24	10.437	2.169	6.159	2.137	1.86	2.041	-2.419	1.945	-6.702
3.275	10.43	2.159	6.144	2.134	1.866	2.033	-2.434	1.932	-6.713
3.339	10.432	2.141	6.139	2.147	1.857	2.009	-2.446	1.927	-6.72
3.386	10.424	2.17	6.141	2.133	1.843	2.046	-2.436	1.933	-6.72
3.42	10.414	2.161	6.12	2.144	1.848	2.031	-2.459	1.914	-6.738
3.479	10.424	2.162	6.127	2.145	1.836	2.02	-2.456	1.916	-6.736
3.519	10.407	2.195	6.12	2.133	1.826	2.04	-2.458	1.923	-6.742
3.544	10.406	2.159	6.097	2.133	1.827	2.032	-2.483	1.91	-6.754
3.587	10.411	2.179	6.108	2.12	1.81	2.018	-2.474	1.924	-6.754
3.613	10.396	2.181	6.098	2.116	1.812	2.043	-2.479	1.923	-6.767

Annex A

3.659	10.396	2.168	6.082	2.131	1.805	2.011	-2.502	1.91	-6.776
3.703	10.394	2.187	6.089	2.116	1.789	2.015	-2.492	1.924	-6.77
3.713	10.382	2.197	6.074	2.13	1.795	2.003	-2.507	1.93	-6.786
3.736	10.388	2.182	6.069	2.153	1.787	1.975	-2.514	1.935	-6.792
3.77	10.379	2.218	6.074	2.141	1.773	1.985	-2.508	1.952	-6.788
3.781	10.37	2.211	6.05	2.164	1.779	1.963	-2.533	1.946	-6.804
3.82	10.377	2.22	6.056	2.156	1.764	1.941	-2.536	1.946	-6.808
3.849	10.362	2.242	6.055	2.136	1.755	1.967	-2.527	1.959	-6.811
3.852	10.354	2.21	6.028	2.161	1.757	1.949	-2.556	1.957	-6.827
3.881	10.357	2.203	6.038	2.164	1.742	1.931	-2.555	1.958	-6.821
3.902	10.344	2.222	6.026	2.17	1.742	1.96	-2.551	1.968	-6.833
3.912	10.343	2.183	6.009	2.188	1.739	1.939	-2.575	1.944	-6.849
3.945	10.34	2.21	6.018	2.186	1.724	1.967	-2.569	1.94	-6.841
3.929	10.324	2.202	6.005	2.18	1.723	1.988	-2.58	1.951	-6.857
3.946	10.332	2.193	5.995	2.182	1.719	1.986	-2.596	1.934	-6.865
3.962	10.323	2.23	6	2.173	1.703	2.011	-2.581	1.942	-6.863
3.955	10.309	2.21	5.979	2.179	1.703	2.013	-2.602	1.937	-6.876
3.975	10.316	2.208	5.982	2.207	1.698	2.006	-2.611	1.933	-6.88
4.004	10.303	2.239	5.983	2.197	1.685	2.022	-2.601	1.947	-6.882
3.985	10.29	2.228	5.959	2.222	1.686	2.021	-2.625	1.931	-6.899
4.002	10.295	2.245	5.967	2.206	1.669	2.007	-2.626	1.937	-6.895
3.999	10.28	2.272	5.961	2.189	1.67	2.028	-2.623	1.953	-6.904
4.002	10.28	2.255	5.939	2.206	1.668	2.019	-2.643	1.943	-6.918
4.01	10.273	2.278	5.952	2.199	1.646	2.02	-2.639	1.954	-6.914
3.996	10.255	2.276	5.937	2.196	1.651	2.027	-2.646	1.956	-6.925
3.99	10.259	2.25	5.928	2.219	1.648	1.997	-2.665	1.946	-6.937
4.002	10.253	2.272	5.936	2.21	1.63	2.004	-2.655	1.938	-6.933
3.983	10.236	2.25	5.908	2.225	1.635	2.019	-2.671	1.932	-6.948
3.984	10.242	2.23	5.91	2.24	1.624	1.982	-2.682	1.92	-6.953
3.987	10.232	2.265	5.915	2.239	1.617	2.006	-2.672	1.922	-6.952
3.97	10.218	2.255	5.888	2.266	1.619	2.007	-2.696	1.912	-6.969
3.981	10.222	2.267	5.897	2.263	1.601	1.987	-2.7	1.906	-6.969
3.98	10.206	2.275	5.892	2.253	1.598	2.002	-2.693	1.931	-6.976
3.969	10.203	2.259	5.87	2.268	1.603	1.983	-2.716	1.91	-6.991
4.017	10.205	2.265	5.879	2.275	1.582	1.994	-2.717	1.92	-6.983
4.022	10.187	2.259	5.865	2.289	1.581	2.011	-2.717	1.911	-6.994
4.037	10.189	2.238	5.854	2.3	1.579	1.985	-2.737	1.893	-7.011
4.059	10.182	2.246	5.865	2.287	1.562	1.981	-2.729	1.897	-7.004
4.038	10.167	2.231	5.842	2.289	1.561	1.982	-2.742	1.894	-7.019
4.046	10.17	2.205	5.839	2.283	1.553	1.934	-2.755	1.884	-7.028
4.045	10.161	2.205	5.844	2.273	1.543	1.948	-2.743	1.889	-7.024

Annex A

4.039	10.15	2.212	5.82	2.277	1.551	1.945	-2.763	1.879	-7.039
4.061	10.152	2.212	5.822	2.272	1.537	1.927	-2.771	1.87	-7.037
4.049	10.142	2.218	5.821	2.258	1.529	1.944	-2.764	1.885	-7.044
4.054	10.136	2.219	5.803	2.271	1.532	1.94	-2.782	1.878	-7.06
4.07	10.137	2.217	5.811	2.261	1.514	1.934	-2.783	1.883	-7.057
4.073	10.12	2.25	5.798	2.253	1.514	1.952	-2.784	1.903	-7.064
4.09	10.121	2.224	5.784	2.272	1.512	1.937	-2.804	1.898	-7.077
4.117	10.12	2.258	5.794	2.246	1.495	1.946	-2.797	1.903	-7.074
4.105	10.102	2.251	5.776	2.251	1.496	1.972	-2.807	1.899	-7.086
4.103	10.104	2.246	5.766	2.256	1.491	1.946	-2.825	1.891	-7.096
4.108	10.096	2.266	5.774	2.215	1.473	1.958	-2.816	1.895	-7.094
4.086	10.081	2.245	5.751	2.217	1.476	1.949	-2.829	1.893	-7.109
4.078	10.083	2.23	5.752	2.202	1.463	1.925	-2.842	1.88	-7.113
4.053	10.072	2.237	5.75	2.165	1.454	1.943	-2.835	1.895	-7.115
4.059	10.064	2.222	5.731	2.178	1.457	1.932	-2.853	1.871	-7.135
4.071	10.066	2.217	5.738	2.163	1.438	1.92	-2.858	1.87	-7.13
4.078	10.052	2.237	5.73	2.139	1.434	1.943	-2.857	1.879	-7.136
4.056	10.049	2.215	5.711	2.147	1.439	1.924	-2.879	1.866	-7.155
4.071	10.048	2.228	5.721	2.142	1.419	1.94	-2.873	1.88	-7.147
4.06	10.032	2.23	5.704	2.149	1.419	1.953	-2.879	1.884	-7.155
4.052	10.032	2.22	5.697	2.163	1.414	1.927	-2.897	1.892	-7.167
4.05	10.026	2.236	5.702	2.139	1.4	1.917	-2.891	1.914	-7.167
4.019	10.011	2.229	5.685	2.151	1.402	1.918	-2.903	1.911	-7.178
4.018	10.011	2.231	5.678	2.151	1.388	1.895	-2.915	1.905	-7.184
3.986	10.001	2.238	5.678	2.122	1.376	1.893	-2.911	1.935	-7.182
3.945	9.99	2.222	5.657	2.117	1.383	1.883	-2.924	1.924	-7.202
3.924	9.993	2.211	5.664	2.104	1.366	1.869	-2.938	1.939	-7.199
3.887	9.975	2.211	5.652	2.082	1.359	1.891	-2.931	1.952	-7.203
3.819	9.967	2.166	5.638	2.099	1.36	1.879	-2.948	1.942	-7.22
3.783	9.968	2.17	5.646	2.082	1.344	1.874	-2.95	1.946	-7.219
3.728	9.95	2.174	5.632	2.084	1.344	1.878	-2.953	1.951	-7.224
3.69	9.951	2.142	5.618	2.11	1.339	1.869	-2.972	1.943	-7.238
3.642	9.943	2.16	5.627	2.094	1.325	1.866	-2.962	1.975	-7.236
3.583	9.927	2.152	5.608	2.105	1.331	1.875	-2.971	1.964	-7.246
3.558	9.93	2.138	5.603	2.115	1.318	1.859	-2.989	1.955	-7.252
3.537	9.916	2.151	5.607	2.084	1.304	1.869	-2.979	1.97	-7.251
3.495	9.904	2.137	5.589	2.079	1.309	1.878	-2.994	1.967	-7.27
3.482	9.908	2.14	5.587	2.062	1.297	1.871	-3.005	1.963	-7.271
3.46	9.894	2.135	5.581	2.034	1.288	1.901	-3.001	1.993	-7.269
3.423	9.882	2.113	5.561	2.032	1.285	1.915	-3.017	1.99	-7.291
3.42	9.884	2.109	5.571	2.005	1.267	1.911	-3.019	2.001	-7.288

Annex A

3.404	9.871	2.118	5.559	1.996	1.265	1.937	-3.02	2.004	-7.296
3.39	9.866	2.09	5.543	2.011	1.266	1.946	-3.038	1.982	-7.308
3.396	9.862	2.098	5.552	1.991	1.247	1.949	-3.037	1.976	-7.308
3.359	9.847	2.085	5.539	2.008	1.251	1.975	-3.04	1.976	-7.317
3.359	9.852	2.067	5.527	2.019	1.242	1.949	-3.056	1.976	-7.325
3.374	9.843	2.096	5.531	1.999	1.228	1.966	-3.055	1.969	-7.326
3.369	9.826	2.08	5.514	2.013	1.234	1.989	-3.059	1.961	-7.339
3.388	9.832	2.079	5.514	2.017	1.218	1.971	-3.074	1.937	-7.344
3.414	9.821	2.098	5.509	2.009	1.211	1.997	-3.071	1.93	-7.344
3.412	9.811	2.084	5.491	2.026	1.216	2.003	-3.082	1.929	-7.358
3.446	9.814	2.083	5.495	2.026	1.198	1.993	-3.091	1.935	-7.361
3.453	9.8	2.096	5.489	2.014	1.193	2.01	-3.089	1.961	-7.367
3.463	9.796	2.073	5.47	2.03	1.192	2.001	-3.106	1.953	-7.38
3.495	9.794	2.079	5.479	2.022	1.176	1.997	-3.106	1.966	-7.38
3.483	9.777	2.099	5.469	2.019	1.177	2.021	-3.108	1.968	-7.388
3.494	9.782	2.084	5.459	2.025	1.171	2.022	-3.127	1.953	-7.396
3.501	9.773	2.118	5.462	1.997	1.157	2.021	-3.121	1.973	-7.396
3.491	9.76	2.128	5.448	1.993	1.164	2.028	-3.128	1.979	-7.41
3.501	9.763	2.149	5.445	2.002	1.153	2.016	-3.139	1.98	-7.416
3.493	9.754	2.173	5.448	1.964	1.139	2.02	-3.135	1.984	-7.415
3.483	9.746	2.164	5.427	1.96	1.143	2.024	-3.147	1.98	-7.431
3.492	9.749	2.168	5.429	1.964	1.13	2.004	-3.158	1.968	-7.434
3.478	9.736	2.174	5.426	1.948	1.125	2.009	-3.156	1.973	-7.431
3.465	9.732	2.175	5.41	1.978	1.122	2.019	-3.168	1.964	-7.447
3.489	9.728	2.181	5.411	1.972	1.106	2.013	-3.175	1.975	-7.45
3.465	9.713	2.179	5.402	1.992	1.109	2.035	-3.173	1.976	-7.458
3.475	9.714	2.162	5.389	2.013	1.104	2.024	-3.191	1.971	-7.465
3.483	9.708	2.159	5.392	2.002	1.084	2.025	-3.196	1.998	-7.464
3.459	9.692	2.142	5.374	2.009	1.092	2.024	-3.195	2.015	-7.478
3.452	9.696	2.11	5.371	2.024	1.085	1.999	-3.21	1.996	-7.489
3.446	9.687	2.137	5.373	2.028	1.07	1.987	-3.211	2.004	-7.48
3.401	9.673	2.126	5.359	2.036	1.073	1.999	-3.219	2.015	-7.501
3.374	9.675	2.118	5.355	2.042	1.062	1.983	-3.231	2.01	-7.506
3.352	9.662	2.145	5.353	2.048	1.057	1.981	-3.23	2.023	-7.503
3.333	9.655	2.148	5.339	2.075	1.058	1.987	-3.24	2.029	-7.516
3.342	9.653	2.159	5.338	2.072	1.041	1.963	-3.253	2.022	-7.518
3.306	9.638	2.183	5.334	2.078	1.037	1.973	-3.245	2.012	-7.525
3.277	9.636	2.19	5.319	2.098	1.037	1.981	-3.263	1.99	-7.539
3.278	9.633	2.191	5.32	2.087	1.02	1.974	-3.268	1.995	-7.533
3.232	9.614	2.179	5.309	2.081	1.022	1.989	-3.266	1.999	-7.543
3.205	9.616	2.175	5.299	2.104	1.015	1.976	-3.283	1.985	-7.554

Annex A

3.204	9.608	2.182	5.303	2.1	1	1.978	-3.285	1.987	-7.554
3.171	9.596	2.191	5.286	2.107	1.006	1.993	-3.29	1.945	-7.569
3.177	9.597	2.19	5.284	2.127	0.993	1.974	-3.302	1.922	-7.577
3.172	9.582	2.204	5.286	2.119	0.983	1.978	-3.298	1.952	-7.575
3.167	9.578	2.204	5.269	2.151	0.989	1.992	-3.312	1.932	-7.593
3.166	9.58	2.206	5.266	2.164	0.975	1.979	-3.324	1.937	-7.593
3.149	9.562	2.212	5.264	2.161	0.971	1.997	-3.317	1.963	-7.597
3.144	9.558	2.186	5.248	2.184	0.966	2.022	-3.328	1.952	-7.614
3.171	9.557	2.196	5.25	2.178	0.951	2.035	-3.339	1.959	-7.609
3.14	9.54	2.199	5.24	2.177	0.953	2.049	-3.337	1.973	-7.62
3.146	9.542	2.181	5.226	2.184	0.951	2.058	-3.352	1.958	-7.633
3.168	9.535	2.193	5.232	2.162	0.933	2.063	-3.354	1.967	-7.626
3.166	9.519	2.189	5.217	2.159	0.933	2.075	-3.358	1.964	-7.643
3.188	9.526	2.173	5.207	2.167	0.925	2.067	-3.376	1.944	-7.649
3.184	9.512	2.159	5.209	2.147	0.913	2.072	-3.372	1.957	-7.646
3.178	9.505	2.153	5.197	2.159	0.914	2.098	-3.38	1.94	-7.661
3.184	9.506	2.136	5.19	2.16	0.9	2.094	-3.392	1.923	-7.667
3.181	9.491	2.146	5.188	2.15	0.898	2.104	-3.387	1.932	-7.671
3.172	9.488	2.144	5.173	2.18	0.9	2.115	-3.398	1.895	-7.682
3.195	9.488	2.151	5.177	2.177	0.88	2.103	-3.409	1.875	-7.682
3.179	9.472	2.175	5.17	2.183	0.88	2.122	-3.406	1.876	-7.694
3.182	9.47	2.159	5.155	2.196	0.879	2.121	-3.42	1.85	-7.707
3.192	9.467	2.192	5.159	2.181	0.862	2.108	-3.425	1.855	-7.699
3.192	9.451	2.206	5.15	2.187	0.864	2.125	-3.427	1.859	-7.711
3.197	9.455	2.212	5.14	2.197	0.854	2.111	-3.442	1.833	-7.724
3.191	9.442	2.225	5.142	2.166	0.846	2.113	-3.441	1.85	-7.719
3.179	9.435	2.234	5.127	2.179	0.848	2.113	-3.449	1.835	-7.736
3.203	9.437	2.254	5.123	2.154	0.83	2.085	-3.466	1.829	-7.74
3.195	9.42	2.26	5.122	2.136	0.825	2.072	-3.46	1.84	-7.741
3.209	9.416	2.268	5.107	2.134	0.829	2.07	-3.475	1.812	-7.759
3.223	9.418	2.279	5.109	2.117	0.81	2.043	-3.487	1.825	-7.757
3.226	9.401	2.312	5.104	2.092	0.807	2.049	-3.481	1.851	-7.76
3.23	9.401	2.287	5.09	2.1	0.805	2.037	-3.496	1.84	-7.779
3.247	9.395	2.297	5.091	2.089	0.787	2.024	-3.502	1.844	-7.771
3.231	9.382	2.308	5.08	2.094	0.792	2.018	-3.504	1.872	-7.782
3.242	9.386	2.292	5.069	2.11	0.783	1.993	-3.518	1.877	-7.797
3.248	9.374	2.307	5.074	2.087	0.769	1.982	-3.516	1.891	-7.788
3.217	9.365	2.319	5.063	2.106	0.774	1.968	-3.522	1.904	-7.802
3.222	9.372	2.33	5.057	2.117	0.763	1.943	-3.539	1.903	-7.809
3.197	9.352	2.329	5.057	2.112	0.754	1.916	-3.534	1.927	-7.807
3.166	9.348	2.321	5.044	2.125	0.758	1.918	-3.543	1.917	-7.826

Annex A

3.159	9.349	2.305	5.04	2.112	0.739	1.895	-3.56	1.909	-7.823
3.136	9.335	2.305	5.032	2.118	0.74	1.892	-3.556	1.918	-7.825
3.119	9.332	2.286	5.022	2.145	0.735	1.879	-3.566	1.893	-7.844
3.114	9.326	2.281	5.027	2.128	0.719	1.859	-3.577	1.898	-7.841
3.081	9.31	2.28	5.017	2.141	0.723	1.866	-3.577	1.91	-7.847
3.083	9.315	2.264	4.999	2.15	0.714	1.858	-3.591	1.876	-7.867
3.096	9.304	2.253	5.004	2.138	0.701	1.854	-3.594	1.889	-7.855
3.061	9.29	2.244	4.993	2.159	0.71	1.868	-3.595	1.871	-7.871
3.065	9.297	2.219	4.983	2.155	0.692	1.853	-3.611	1.852	-7.883
3.052	9.279	2.21	4.983	2.132	0.685	1.866	-3.608	1.862	-7.877
3.028	9.272	2.176	4.967	2.158	0.69	1.886	-3.616	1.852	-7.895
3.03	9.277	2.151	4.967	2.151	0.674	1.874	-3.632	1.842	-7.894
3.007	9.256	2.152	4.959	2.158	0.666	1.869	-3.628	1.847	-7.899
2.994	9.257	2.125	4.942	2.17	0.668	1.88	-3.64	1.83	-7.922
2.976	9.25	2.093	4.946	2.148	0.649	1.876	-3.649	1.842	-7.911
2.925	9.234	2.097	4.938	2.163	0.653	1.893	-3.644	1.862	-7.919
2.907	9.236	2.058	4.922	2.186	0.642	1.882	-3.661	1.855	-7.941
2.91	9.226	2.059	4.921	2.17	0.63	1.881	-3.665	1.862	-7.931
2.869	9.21	2.045	4.913	2.185	0.635	1.896	-3.664	1.881	-7.941
2.875	9.219	2.038	4.902	2.193	0.622	1.892	-3.682	1.872	-7.954
2.878	9.204	2.043	4.902	2.171	0.613	1.909	-3.678	1.894	-7.95
2.86	9.19	2.045	4.888	2.205	0.619	1.938	-3.683	1.891	-7.964
2.866	9.197	2.042	4.886	2.199	0.599	1.93	-3.701	1.878	-7.965
2.857	9.178	2.068	4.886	2.192	0.593	1.935	-3.697	1.904	-7.967
2.844	9.18	2.053	4.866	2.206	0.596	1.939	-3.704	1.886	-7.99
2.85	9.176	2.04	4.866	2.193	0.581	1.952	-3.718	1.886	-7.984
2.849	9.158	2.042	4.861	2.206	0.581	1.953	-3.717	1.906	-7.986
2.863	9.164	2.036	4.849	2.215	0.573	1.964	-3.728	1.895	-8.011
2.879	9.153	2.03	4.85	2.188	0.557	1.958	-3.737	1.906	-8
2.855	9.138	2.038	4.839	2.208	0.565	1.988	-3.733	1.903	-8.009
2.873	9.145	2.013	4.831	2.226	0.551	1.989	-3.753	1.885	-8.025
2.878	9.134	2.026	4.832	2.204	0.539	1.98	-3.752	1.885	-8.019
2.862	9.12	2.022	4.818	2.218	0.545	2.004	-3.752	1.879	-8.036
2.877	9.128	2.017	4.815	2.215	0.53	1.987	-3.771	1.859	-8.041
2.861	9.109	2.025	4.814	2.207	0.522	1.988	-3.769	1.896	-8.035
2.85	9.108	2.023	4.798	2.224	0.525	1.987	-3.775	1.894	-8.059
2.871	9.104	2.031	4.798	2.223	0.506	1.977	-3.787	1.897	-8.057
2.837	9.085	2.067	4.793	2.229	0.509	1.985	-3.784	1.923	-8.054
2.834	9.09	2.068	4.777	2.234	0.506	1.98	-3.799	1.902	-8.078
2.844	9.081	2.069	4.779	2.196	0.485	1.962	-3.807	1.909	-8.069
2.814	9.063	2.082	4.774	2.182	0.493	1.979	-3.803	1.934	-8.078

Annex A

2.817	9.072	2.072	4.762	2.183	0.48	1.971	-3.823	1.901	-8.096
2.806	9.058	2.086	4.761	2.147	0.466	1.956	-3.825	1.917	-8.089
2.779	9.047	2.071	4.749	2.163	0.474	1.979	-3.825	1.917	-8.106
2.796	9.052	2.058	4.745	2.167	0.458	1.961	-3.841	1.9	-8.113
2.781	9.035	2.067	4.744	2.153	0.451	1.97	-3.842	1.92	-8.106
2.756	9.031	2.059	4.726	2.162	0.456	1.963	-3.846	1.902	-8.125
2.785	9.029	2.077	4.725	2.153	0.434	1.96	-3.862	1.891	-8.13
2.748	9.009	2.091	4.726	2.148	0.435	1.979	-3.854	1.915	-8.126
2.748	9.016	2.093	4.711	2.172	0.432	1.998	-3.87	1.9	-8.152
2.775	9.012	2.093	4.709	2.14	0.413	1.986	-3.877	1.907	-8.142
2.77	8.991	2.11	4.701	2.131	0.423	1.999	-3.87	1.925	-8.146
2.806	9	2.109	4.692	2.141	0.409	1.994	-3.89	1.9	-8.17
2.82	8.987	2.121	4.695	2.101	0.391	1.992	-3.896	1.92	-8.157
2.81	8.979	2.121	4.681	2.107	0.403	2.012	-3.892	1.922	-8.172
2.83	8.986	2.103	4.675	2.101	0.384	2.016	-3.91	1.892	-8.182
2.831	8.969	2.117	4.679	2.095	0.375	1.987	-3.911	1.896	-8.174
2.843	8.967	2.102	4.663	2.11	0.385	1.988	-3.914	1.887	-8.198
2.871	8.971	2.089	4.657	2.09	0.365	1.978	-3.93	1.858	-8.202
2.875	8.951	2.106	4.656	2.059	0.365	1.983	-3.928	1.878	-8.193
2.883	8.953	2.093	4.644	2.053	0.361	1.993	-3.936	1.852	-8.217
2.912	8.951	2.118	4.643	2.026	0.337	1.986	-3.95	1.842	-8.217
2.913	8.929	2.117	4.635	2.025	0.348	2.005	-3.943	1.862	-8.213
2.936	8.943	2.111	4.623	2.041	0.344	2.006	-3.957	1.84	-8.236
2.959	8.925	2.127	4.628	2.017	0.32	2.008	-3.962	1.85	-8.23
2.947	8.914	2.148	4.616	2.021	0.331	2.016	-3.963	1.867	-8.239
2.956	8.922	2.142	4.605	2.038	0.32	2.016	-3.98	1.842	-8.254
2.946	8.9	2.159	4.606	2.006	0.304	2.013	-3.985	1.858	-8.243
2.936	8.898	2.169	4.592	2.031	0.311	2.014	-3.983	1.867	-8.266
2.947	8.9	2.164	4.588	2.015	0.29	1.996	-3.999	1.844	-8.276
2.919	8.879	2.17	4.589	2.006	0.291	2.01	-3.999	1.854	-8.262
2.902	8.883	2.163	4.573	2.045	0.294	2.01	-4.009	1.856	-8.289
2.917	8.88	2.172	4.571	2.028	0.268	2.014	-4.021	1.831	-8.289
2.892	8.856	2.19	4.569	2.03	0.277	2.013	-4.013	1.848	-8.287
2.879	8.865	2.182	4.555	2.061	0.271	2.023	-4.028	1.825	-8.307
2.875	8.853	2.199	4.556	2.054	0.25	2.009	-4.039	1.83	-8.303
2.832	8.838	2.204	4.545	2.065	0.261	2.014	-4.031	1.841	-8.307
2.858	8.849	2.195	4.538	2.079	0.247	2.007	-4.047	1.814	-8.327
2.858	8.83	2.21	4.54	2.075	0.235	2	-4.057	1.835	-8.32
2.825	8.824	2.216	4.526	2.117	0.244	2	-4.056	1.842	-8.334
2.859	8.83	2.205	4.518	2.118	0.223	1.996	-4.07	1.821	-8.345
2.852	8.804	2.221	4.518	2.095	0.217	2.002	-4.072	1.841	-8.337

Annex A

2.836	8.807	2.197	4.505	2.112	0.225	2.011	-4.08	1.833	-8.354
2.853	8.808	2.196	4.501	2.092	0.199	1.993	-4.097	1.798	-8.365
2.833	8.786	2.2	4.495	2.09	0.2	2.003	-4.088	1.799	-8.357
2.842	8.793	2.167	4.484	2.104	0.199	2.014	-4.098	1.768	-8.384
2.867	8.783	2.165	4.487	2.089	0.176	1.972	-4.115	1.748	-8.381
2.834	8.77	2.171	4.475	2.098	0.187	1.978	-4.109	1.739	-8.382
2.844	8.78	2.148	4.462	2.106	0.178	1.97	-4.123	1.714	-8.402
2.834	8.756	2.154	4.47	2.088	0.162	1.963	-4.127	1.722	-8.394
2.796	8.749	2.16	4.455	2.099	0.174	1.978	-4.129	1.746	-8.407
2.801	8.759	2.163	4.446	2.103	0.157	1.959	-4.143	1.723	-8.421
2.791	8.735	2.178	4.448	2.079	0.148	1.953	-4.147	1.733	-8.409
2.789	8.733	2.188	4.435	2.097	0.154	1.953	-4.151	1.752	-8.427
2.787	8.735	2.181	4.43	2.094	0.13	1.934	-4.165	1.735	-8.438
2.772	8.716	2.196	4.425	2.071	0.131	1.945	-4.163	1.749	-8.429
2.784	8.719	2.179	4.41	2.097	0.134	1.954	-4.172	1.752	-8.445
2.802	8.708	2.191	4.413	2.082	0.109	1.919	-4.189	1.752	-8.454
2.785	8.692	2.191	4.405	2.081	0.113	1.908	-4.183	1.766	-8.452
2.793	8.706	2.193	4.389	2.1	0.11	1.897	-4.197	1.747	-8.472
2.804	8.688	2.205	4.395	2.098	0.09	1.89	-4.209	1.754	-8.467
2.778	8.673	2.218	4.385	2.11	0.098	1.9	-4.204	1.766	-8.473
2.787	8.686	2.233	4.377	2.127	0.085	1.894	-4.216	1.749	-8.493
2.781	8.666	2.261	4.378	2.113	0.077	1.903	-4.222	1.759	-8.484
2.771	8.663	2.252	4.367	2.14	0.083	1.915	-4.223	1.773	-8.495
2.787	8.663	2.247	4.365	2.132	0.065	1.927	-4.238	1.746	-8.51
2.774	8.644	2.268	4.359	2.125	0.058	1.919	-4.237	1.765	-8.502
2.775	8.646	2.242	4.342	2.139	0.063	1.941	-4.244	1.778	-8.514
2.777	8.642	2.231	4.343	2.137	0.042	1.926	-4.263	1.773	-8.52
2.747	8.623	2.234	4.338	2.114	0.039	1.933	-4.252	1.799	-8.518
2.742	8.63	2.203	4.32	2.121	0.039	1.959	-4.264	1.798	-8.54
2.73	8.616	2.183	4.322	2.109	0.021	1.943	-4.279	1.786	-8.538
2.697	8.603	2.165	4.312	2.117	0.025	1.941	-4.273	1.813	-8.538
2.708	8.612	2.142	4.301	2.117	0.014	1.925	-4.287	1.766	-8.559
2.688	8.59	2.142	4.302	2.092	0.001	1.904	-4.291	1.784	-8.553
2.667	8.587	2.123	4.292	2.108	0.011	1.906	-4.294	1.782	-8.561
2.677	8.592	2.108	4.284	2.104	-0.01	1.895	-4.311	1.766	-8.579
2.654	8.572	2.107	4.286	2.086	-0.014	1.898	-4.307	1.775	-8.57
2.657	8.573	2.083	4.269	2.09	-0.008	1.92	-4.309	1.784	-8.583
2.664	8.57	2.068	4.27	2.077	-0.026	1.906	-4.327	1.766	-8.595
2.653	8.551	2.078	4.264	2.062	-0.028	1.91	-4.322	1.782	-8.59
2.643	8.555	2.054	4.247	2.06	-0.029	1.913	-4.328	1.783	-8.604
2.643	8.546	2.045	4.25	2.022	-0.051	1.903	-4.343	1.785	-8.608

Annex A

2.609	8.527	2.057	4.241	2.004	-0.048	1.892	-4.342	1.81	-8.609
2.618	8.538	2.035	4.229	2	-0.056	1.88	-4.356	1.799	-8.624
2.607	8.522	2.037	4.229	1.962	-0.071	1.865	-4.36	1.797	-8.623
2.603	8.508	2.034	4.216	1.969	-0.066	1.888	-4.36	1.811	-8.627
2.615	8.516	2.03	4.213	1.983	-0.08	1.88	-4.376	1.789	-8.649
2.609	8.498	2.058	4.214	1.97	-0.091	1.88	-4.38	1.783	-8.641
2.613	8.499	2.059	4.197	1.995	-0.082	1.897	-4.38	1.795	-8.651
2.636	8.497	2.075	4.198	2.014	-0.102	1.891	-4.398	1.789	-8.667
2.623	8.477	2.115	4.194	2.03	-0.102	1.886	-4.397	1.811	-8.66
2.627	8.482	2.113	4.177	2.043	-0.102	1.893	-4.401	1.821	-8.672
2.647	8.477	2.126	4.181	2.042	-0.121	1.883	-4.418	1.829	-8.677
2.642	8.456	2.147	4.177	2.046	-0.119	1.892	-4.412	1.828	-8.675
2.631	8.463	2.138	4.16	2.059	-0.125	1.915	-4.426	1.825	-8.695
2.622	8.453	2.152	4.163	2.037	-0.142	1.913	-4.435	1.81	-8.697
2.597	8.44	2.143	4.148	2.03	-0.136	1.946	-4.431	1.834	-8.694
2.611	8.447	2.119	4.142	2.014	-0.147	1.957	-4.447	1.836	-8.718
2.605	8.427	2.128	4.14	1.979	-0.164	1.95	-4.446	1.831	-8.715
2.59	8.424	2.126	4.126	1.978	-0.157	1.986	-4.447	1.852	-8.72
2.593	8.425	2.116	4.125	1.987	-0.172	1.979	-4.469	1.84	-8.735
2.591	8.404	2.145	4.123	1.963	-0.181	1.983	-4.466	1.835	-8.734
2.586	8.407	2.133	4.107	1.966	-0.177	1.984	-4.471	1.835	-8.745
2.599	8.404	2.14	4.106	1.953	-0.193	1.992	-4.487	1.816	-8.754
2.601	8.389	2.17	4.103	1.958	-0.194	2.012	-4.483	1.82	-8.75
2.621	8.39	2.182	4.091	1.991	-0.197	2.029	-4.491	1.809	-8.765
2.639	8.383	2.216	4.093	1.971	-0.214	2.029	-4.505	1.792	-8.774
2.637	8.369	2.231	4.083	1.982	-0.208	2.038	-4.501	1.824	-8.77
2.639	8.375	2.227	4.072	2	-0.216	2.038	-4.516	1.822	-8.784
2.659	8.359	2.24	4.078	1.985	-0.236	2.028	-4.519	1.825	-8.787
2.651	8.349	2.24	4.059	1.996	-0.227	2.035	-4.515	1.838	-8.79
2.672	8.356	2.231	4.053	1.993	-0.238	2.031	-4.538	1.826	-8.808
2.681	8.337	2.227	4.057	1.981	-0.253	2.024	-4.537	1.837	-8.805
2.667	8.337	2.214	4.039	1.997	-0.249	2.034	-4.539	1.854	-8.812
2.689	8.335	2.208	4.038	2.008	-0.263	2.022	-4.557	1.853	-8.826
2.683	8.316	2.218	4.032	2.005	-0.269	2.016	-4.553	1.871	-8.823
2.695	8.322	2.204	4.019	2.023	-0.268	2.009	-4.562	1.876	-8.836
2.718	8.317	2.209	4.02	2.015	-0.287	1.995	-4.575	1.86	-8.842
2.699	8.297	2.205	4.01	2.014	-0.283	1.995	-4.569	1.881	-8.838
2.722	8.303	2.191	3.999	2.036	-0.286	1.993	-4.586	1.889	-8.857
2.728	8.29	2.212	4.003	2.014	-0.307	1.959	-4.597	1.864	-8.862
2.711	8.283	2.212	3.989	2.008	-0.302	1.971	-4.589	1.863	-8.857
2.72	8.285	2.195	3.982	2.025	-0.307	1.98	-4.607	1.856	-8.876

Annex A

2.729	8.269	2.203	3.982	2.008	-0.324	1.953	-4.614	1.856	-8.88
2.716	8.265	2.193	3.966	2.005	-0.317	1.958	-4.614	1.862	-8.882
2.731	8.27	2.193	3.965	2.01	-0.33	1.953	-4.629	1.847	-8.897
2.731	8.246	2.198	3.958	2.005	-0.341	1.952	-4.629	1.85	-8.895
2.737	8.248	2.185	3.944	2.028	-0.34	1.96	-4.635	1.857	-8.904
2.738	8.244	2.193	3.947	2.036	-0.352	1.954	-4.649	1.839	-8.917
2.712	8.232	2.203	3.94	2.036	-0.357	1.985	-4.645	1.841	-8.91
2.72	8.231	2.186	3.929	2.057	-0.355	1.992	-4.655	1.834	-8.926
2.721	8.221	2.208	3.931	2.043	-0.375	1.992	-4.668	1.823	-8.935
2.7	8.209	2.219	3.919	2.038	-0.372	2.004	-4.661	1.835	-8.931
2.702	8.217	2.214	3.911	2.048	-0.377	2.022	-4.68	1.84	-8.943
2.693	8.201	2.229	3.915	2.043	-0.394	2.011	-4.682	1.84	-8.947
2.659	8.188	2.241	3.898	2.067	-0.387	2.028	-4.68	1.864	-8.949
2.676	8.195	2.25	3.894	2.088	-0.395	2.029	-4.698	1.847	-8.963
2.682	8.182	2.26	3.896	2.077	-0.407	2.022	-4.697	1.843	-8.961
2.686	8.18	2.252	3.882	2.082	-0.404	2.033	-4.7	1.854	-8.97
2.7	8.176	2.26	3.882	2.076	-0.42	2.007	-4.714	1.83	-8.982
2.681	8.161	2.282	3.873	2.071	-0.423	2.018	-4.706	1.837	-8.983
2.688	8.166	2.26	3.859	2.094	-0.423	2.016	-4.72	1.838	-8.992
2.697	8.152	2.257	3.866	2.083	-0.441	1.985	-4.733	1.819	-9.001
2.671	8.141	2.243	3.852	2.09	-0.441	1.987	-4.726	1.811	-8.999
2.682	8.147	2.224	3.839	2.113	-0.441	1.982	-4.741	1.798	-9.013
2.68	8.138	2.23	3.845	2.107	-0.459	1.973	-4.751	1.77	-9.02
2.672	8.125	2.229	3.829	2.116	-0.458	1.986	-4.747	1.785	-9.016
2.694	8.128	2.218	3.826	2.12	-0.465	1.99	-4.762	1.755	-9.035
2.698	8.113	2.236	3.823	2.101	-0.477	1.992	-4.763	1.747	-9.035
2.679	8.108	2.23	3.807	2.116	-0.473	2.002	-4.766	1.747	-9.038
2.672	8.106	2.232	3.811	2.118	-0.485	1.987	-4.787	1.724	-9.057
2.649	8.091	2.252	3.806	2.11	-0.495	1.983	-4.777	1.718	-9.054
2.65	8.092	2.232	3.788	2.127	-0.492	1.986	-4.789	1.723	-9.063
2.66	8.086	2.234	3.791	2.115	-0.51	1.959	-4.803	1.703	-9.078
2.649	8.069	2.234	3.783	2.094	-0.513	1.98	-4.794	1.697	-9.073
2.665	8.074	2.226	3.769	2.101	-0.514	1.98	-4.811	1.701	-9.083
2.672	8.065	2.226	3.771	2.068	-0.535	1.979	-4.824	1.678	-9.097
2.662	8.052	2.231	3.759	2.055	-0.531	2.005	-4.817	1.685	-9.092
2.678	8.057	2.225	3.754	2.071	-0.54	2.002	-4.834	1.681	-9.105
2.682	8.043	2.242	3.753	2.055	-0.552	1.993	-4.832	1.674	-9.11
2.667	8.033	2.239	3.737	2.064	-0.547	2.026	-4.837	1.692	-9.113
2.668	8.037	2.243	3.736	2.078	-0.56	2.014	-4.853	1.678	-9.129
2.657	8.021	2.252	3.733	2.058	-0.57	2.045	-4.848	1.681	-9.124
2.646	8.019	2.236	3.716	2.07	-0.564	2.058	-4.857	1.681	-9.135

Annex A

2.652	8.012	2.241	3.72	2.069	-0.582	2.052	-4.876	1.672	-9.149
2.623	7.998	2.261	3.709	2.058	-0.585	2.064	-4.864	1.681	-9.143
2.606	8	2.246	3.699	2.054	-0.589	2.059	-4.882	1.687	-9.151
2.607	7.99	2.275	3.704	2.039	-0.604	2.04	-4.891	1.681	-9.167
2.58	7.975	2.261	3.69	2.042	-0.608	2.028	-4.885	1.694	-9.163
2.564	7.982	2.246	3.68	2.04	-0.608	1.999	-4.904	1.685	-9.177
2.541	7.97	2.258	3.68	2.037	-0.622	1.973	-4.909	1.671	-9.182
2.517	7.961	2.246	3.666	2.037	-0.621	1.983	-4.906	1.688	-9.183
2.529	7.96	2.245	3.669	2.063	-0.631	1.945	-4.929	1.682	-9.2
2.509	7.942	2.259	3.662	2.067	-0.642	1.94	-4.925	1.687	-9.198
2.504	7.943	2.256	3.644	2.079	-0.636	1.952	-4.932	1.716	-9.202
2.522	7.939	2.266	3.654	2.083	-0.651	1.925	-4.951	1.707	-9.218
2.505	7.92	2.28	3.64	2.072	-0.659	1.929	-4.94	1.709	-9.216
2.509	7.923	2.273	3.626	2.091	-0.655	1.96	-4.954	1.729	-9.222
2.521	7.918	2.277	3.629	2.096	-0.671	1.936	-4.966	1.734	-9.235
2.51	7.901	2.27	3.619	2.085	-0.675	1.953	-4.96	1.74	-9.233
2.533	7.903	2.253	3.612	2.101	-0.677	1.953	-4.978	1.733	-9.245
2.541	7.894	2.279	3.609	2.072	-0.695	1.96	-4.984	1.725	-9.254
2.546	7.887	2.246	3.595	2.077	-0.692	1.977	-4.98	1.744	-9.251
2.565	7.89	2.237	3.595	2.062	-0.698	1.955	-4.997	1.736	-9.268
2.569	7.873	2.245	3.592	2.045	-0.715	1.974	-4.994	1.731	-9.269
2.582	7.871	2.232	3.572	2.052	-0.708	1.991	-4.999	1.727	-9.274
2.599	7.872	2.22	3.578	2.054	-0.72	1.977	-5.018	1.708	-9.29
2.603	7.853	2.232	3.571	2.036	-0.734	1.978	-5.009	1.698	-9.286
2.607	7.855	2.215	3.555	2.034	-0.73	1.995	-5.024	1.718	-9.291
2.624	7.851	2.236	3.556	2.018	-0.743	1.979	-5.036	1.716	-9.306
2.633	7.838	2.23	3.544	2.006	-0.748	1.991	-5.028	1.729	-9.301
2.652	7.838	2.223	3.537	2.011	-0.752	1.981	-5.045	1.742	-9.311
2.661	7.826	2.234	3.541	1.989	-0.766	1.958	-5.052	1.738	-9.322
2.645	7.818	2.224	3.522	1.986	-0.768	1.975	-5.051	1.754	-9.322
2.659	7.823	2.204	3.519	1.987	-0.774	1.959	-5.072	1.765	-9.335
2.675	7.802	2.217	3.519	1.963	-0.788	1.967	-5.066	1.762	-9.34
2.652	7.801	2.194	3.501	1.944	-0.783	1.991	-5.069	1.779	-9.34
2.645	7.806	2.174	3.503	1.942	-0.792	1.963	-5.09	1.781	-9.358
2.627	7.79	2.183	3.497	1.92	-0.808	1.984	-5.082	1.791	-9.358
2.623	7.787	2.16	3.483	1.93	-0.802	1.98	-5.087	1.815	-9.356
2.629	7.786	2.177	3.49	1.934	-0.816	1.962	-5.105	1.816	-9.374
2.607	7.77	2.176	3.476	1.942	-0.823	1.98	-5.097	1.833	-9.374
2.614	7.771	2.167	3.465	1.962	-0.822	1.99	-5.114	1.848	-9.379
2.623	7.763	2.189	3.472	1.955	-0.837	1.964	-5.12	1.858	-9.388
2.605	7.751	2.198	3.455	1.984	-0.836	1.988	-5.114	1.871	-9.383

Annex A

2.609	7.755	2.18	3.452	1.989	-0.84	1.983	-5.135	1.867	-9.397
2.601	7.738	2.196	3.454	1.991	-0.857	1.973	-5.134	1.848	-9.401
2.583	7.732	2.179	3.434	1.996	-0.855	1.989	-5.137	1.85	-9.4
2.6	7.734	2.186	3.433	2.002	-0.862	1.968	-5.159	1.839	-9.422
2.603	7.717	2.209	3.432	1.98	-0.878	1.967	-5.151	1.834	-9.421
2.6	7.717	2.207	3.413	1.981	-0.873	1.968	-5.162	1.866	-9.419
2.623	7.713	2.226	3.422	2.001	-0.883	1.927	-5.18	1.864	-9.439
2.62	7.697	2.231	3.409	1.986	-0.893	1.95	-5.168	1.86	-9.438
2.642	7.702	2.22	3.397	1.997	-0.893	1.936	-5.185	1.868	-9.446
2.664	7.693	2.23	3.403	1.999	-0.906	1.927	-5.194	1.853	-9.456
2.666	7.683	2.227	3.384	2.013	-0.909	1.95	-5.187	1.859	-9.455
2.687	7.687	2.223	3.383	2.032	-0.912	1.941	-5.21	1.862	-9.466
2.692	7.672	2.238	3.384	2.021	-0.929	1.928	-5.211	1.859	-9.475
2.684	7.663	2.242	3.362	2.031	-0.925	1.944	-5.207	1.879	-9.473
2.687	7.664	2.233	3.363	2.033	-0.933	1.929	-5.232	1.879	-9.489
2.679	7.651	2.265	3.361	2.034	-0.953	1.919	-5.224	1.87	-9.494
2.661	7.644	2.245	3.343	2.026	-0.945	1.933	-5.228	1.882	-9.49
2.664	7.645	2.281	3.35	2.04	-0.954	1.903	-5.252	1.864	-9.511
2.647	7.625	2.283	3.337	2.025	-0.967	1.913	-5.244	1.853	-9.513
2.647	7.629	2.248	3.323	2.037	-0.965	1.922	-5.256	1.858	-9.515
2.662	7.621	2.273	3.334	2.022	-0.977	1.896	-5.267	1.846	-9.533
2.641	7.61	2.258	3.312	2.005	-0.979	1.927	-5.26	1.861	-9.529
2.664	7.615	2.247	3.307	2.016	-0.981	1.925	-5.277	1.876	-9.538
2.675	7.601	2.268	3.314	2.001	-0.999	1.93	-5.28	1.872	-9.546
2.679	7.59	2.251	3.294	1.995	-0.999	1.961	-5.274	1.886	-9.542
2.689	7.598	2.258	3.293	1.999	-1.003	1.951	-5.3	1.898	-9.56
2.688	7.58	2.275	3.293	1.967	-1.023	1.956	-5.295	1.883	-9.568
2.693	7.576	2.251	3.272	1.969	-1.02	1.971	-5.295	1.888	-9.562
2.686	7.574	2.263	3.278	1.979	-1.027	1.952	-5.318	1.879	-9.575
2.65	7.559	2.287	3.269	1.965	-1.039	1.978	-5.308	1.868	-9.582
2.65	7.559	2.263	3.255	1.961	-1.037	1.995	-5.324	1.875	-9.584
2.654	7.55	2.271	3.262	1.957	-1.056	1.975	-5.337	1.854	-9.599
2.614	7.534	2.282	3.244	1.946	-1.06	1.996	-5.324	1.865	-9.597
2.621	7.541	2.27	3.235	1.954	-1.057	1.98	-5.35	1.883	-9.609
2.617	7.528	2.293	3.242	1.952	-1.077	1.954	-5.355	1.866	-9.619
2.602	7.516	2.291	3.219	1.957	-1.073	1.984	-5.346	1.868	-9.615
2.6	7.522	2.288	3.224	1.988	-1.075	1.958	-5.37	1.856	-9.63
2.583	7.509	2.296	3.22	1.987	-1.093	1.934	-5.372	1.845	-9.637
2.585	7.503	2.273	3.202	1.987	-1.09	1.964	-5.366	1.846	-9.634
2.602	7.5	2.268	3.208	2.014	-1.098	1.956	-5.393	1.836	-9.649
2.589	7.487	2.296	3.198	1.999	-1.11	1.971	-5.383	1.819	-9.656

Annex A

2.599	7.484	2.264	3.181	1.999	-1.106	1.99	-5.389	1.827	-9.657
2.599	7.48	2.286	3.19	2.006	-1.117	1.978	-5.407	1.804	-9.672
2.581	7.464	2.283	3.174	1.997	-1.129	2.012	-5.398	1.806	-9.672
2.578	7.467	2.262	3.161	2.019	-1.128	2.018	-5.418	1.817	-9.677
2.579	7.458	2.292	3.171	2.015	-1.141	1.989	-5.426	1.792	-9.694
2.567	7.444	2.259	3.151	1.995	-1.143	2.012	-5.417	1.803	-9.688
2.568	7.446	2.249	3.147	2.011	-1.145	2.005	-5.443	1.824	-9.699
2.57	7.433	2.256	3.149	1.99	-1.164	1.99	-5.442	1.814	-9.713
2.565	7.429	2.225	3.129	2.003	-1.162	1.994	-5.437	1.832	-9.707
2.563	7.431	2.222	3.134	2.026	-1.165	1.98	-5.461	1.827	-9.719
2.559	7.414	2.235	3.125	2.019	-1.179	1.996	-5.456	1.827	-9.727
2.572	7.416	2.183	3.108	2.024	-1.178	2.007	-5.461	1.835	-9.727
2.587	7.412	2.164	3.119	2.021	-1.184	1.984	-5.479	1.828	-9.742
2.576	7.397	2.156	3.105	2.009	-1.193	2.007	-5.472	1.816	-9.744
2.58	7.398	2.124	3.093	2.028	-1.19	2.023	-5.482	1.83	-9.745
2.594	7.392	2.147	3.104	2.035	-1.21	2	-5.496	1.793	-9.761
2.574	7.375	2.146	3.08	2.026	-1.215	2.029	-5.483	1.782	-9.761
2.588	7.381	2.137	3.077	2.05	-1.208	2.042	-5.505	1.792	-9.767
2.573	7.37	2.156	3.08	2.037	-1.227	2.024	-5.513	1.763	-9.782
2.558	7.362	2.128	3.059	2.007	-1.231	2.048	-5.504	1.775	-9.775
2.565	7.36	2.123	3.063	2.009	-1.234	2.042	-5.527	1.78	-9.787
2.539	7.346	2.142	3.055	1.985	-1.249	2.017	-5.528	1.764	-9.8
2.521	7.344	2.107	3.036	2.002	-1.251	2.02	-5.531	1.755	-9.797

Table 12. Tensile Trial 6 Results.

F (Kg)	D (mm)	F (Kg)	D (mm)	F (Kg)	D (mm)	F (Kg)	D (mm)	F (Kg)	D (mm)
-1.761	9.145	5.109	6.028	5.331	1.383	2.517	-3.424	1.712	-8.144
-1.756	9.143	5.15	6.026	5.361	1.38	2.522	-3.433	1.69	-8.165
-1.769	9.138	5.142	6.004	5.364	1.358	2.515	-3.456	1.7	-8.162
-1.762	9.147	5.117	5.996	5.37	1.353	2.517	-3.459	1.71	-8.186
-1.759	9.14	5.111	5.985	5.391	1.345	2.503	-3.479	1.695	-8.198
-1.764	9.142	5.074	5.961	5.357	1.316	2.473	-3.495	1.7	-8.202
-1.757	9.147	5.052	5.958	5.379	1.317	2.484	-3.497	1.693	-8.225
-1.765	9.138	5.025	5.936	5.382	1.297	2.476	-3.521	1.702	-8.228
-1.758	9.144	5.007	5.926	5.36	1.283	2.485	-3.526	1.701	-8.244
-1.765	9.144	5.037	5.923	5.367	1.279	2.466	-3.537	1.681	-8.262
-1.766	9.141	5.012	5.898	5.367	1.255	2.439	-3.558	1.712	-8.26
-1.754	9.146	5.029	5.899	5.362	1.251	2.448	-3.559	1.698	-8.291
-1.758	9.139	5.056	5.881	5.371	1.236	2.464	-3.582	1.686	-8.296

Annex A

-1.772	9.143	5.038	5.86	5.369	1.212	2.461	-3.593	1.697	-8.303
-1.763	9.146	5.034	5.861	5.392	1.216	2.489	-3.596	1.695	-8.33
-1.768	9.138	5.071	5.846	5.395	1.194	2.477	-3.621	1.701	-8.328
-1.768	9.144	5.1	5.835	5.373	1.182	2.465	-3.627	1.693	-8.345
-1.76	9.144	5.136	5.826	5.388	1.179	2.457	-3.643	1.683	-8.364
-1.768	9.14	5.116	5.804	5.369	1.156	2.437	-3.659	1.701	-8.365
-1.758	9.146	5.106	5.806	5.389	1.153	2.45	-3.662	1.687	-8.394
-1.759	9.14	5.102	5.783	5.373	1.138	2.45	-3.685	1.693	-8.396
-1.771	9.143	5.09	5.763	5.338	1.119	2.423	-3.694	1.701	-8.408
-1.76	9.146	5.117	5.763	5.36	1.118	2.464	-3.702	1.684	-8.432
-1.764	9.137	5.104	5.744	5.361	1.089	2.456	-3.727	1.68	-8.43
-1.763	9.144	5.089	5.73	5.342	1.084	2.438	-3.731	1.681	-8.451
-1.763	9.144	5.097	5.719	5.33	1.076	2.413	-3.747	1.693	-8.464
-1.768	9.14	5.082	5.697	5.322	1.052	2.365	-3.764	1.702	-8.469
-1.765	9.145	5.109	5.696	5.335	1.049	2.377	-3.767	1.656	-8.497
-1.755	9.14	5.103	5.674	5.319	1.031	2.369	-3.793	1.659	-8.499
-1.763	9.143	5.077	5.66	5.29	1.014	2.379	-3.799	1.666	-8.509
-1.755	9.146	5.111	5.66	5.314	1.012	2.406	-3.809	1.639	-8.535
-1.763	9.139	5.14	5.639	5.315	0.986	2.38	-3.831	1.664	-8.531
-1.763	9.144	5.157	5.626	5.301	0.982	2.413	-3.829	1.664	-8.554
-1.753	9.145	5.156	5.617	5.313	0.971	2.43	-3.852	1.666	-8.565
-1.767	9.139	5.113	5.595	5.264	0.947	2.431	-3.866	1.675	-8.572
-1.762	9.146	5.149	5.591	5.262	0.943	2.451	-3.87	1.648	-8.598
-1.763	9.143	5.167	5.574	5.26	0.923	2.43	-3.893	1.647	-8.596
-1.765	9.142	5.166	5.563	5.243	0.911	2.426	-3.895	1.627	-8.613
-1.76	9.146	5.191	5.557	5.261	0.906	2.414	-3.914	1.62	-8.631
-1.773	9.14	5.166	5.532	5.246	0.88	2.4	-3.93	1.622	-8.634
-1.767	9.145	5.173	5.523	5.26	0.877	2.4	-3.933	1.635	-8.659
-1.761	9.144	5.169	5.514	5.27	0.865	2.409	-3.957	1.623	-8.666
-1.77	9.138	5.157	5.494	5.229	0.842	2.391	-3.967	1.656	-8.675
-1.763	9.147	5.17	5.492	5.245	0.843	2.401	-3.973	1.645	-8.698
-1.759	9.14	5.192	5.471	5.217	0.816	2.364	-4	1.651	-8.697
-1.775	9.141	5.198	5.467	5.188	0.809	2.357	-4.004	1.645	-8.717
-1.764	9.147	5.249	5.457	5.205	0.802	2.363	-4.021	1.62	-8.734
-1.772	9.139	5.232	5.433	5.194	0.774	2.329	-4.036	1.617	-8.737
-1.766	9.144	5.213	5.432	5.209	0.777	2.331	-4.039	1.609	-8.763
-1.765	9.143	5.219	5.416	5.216	0.758	2.304	-4.065	1.611	-8.769
-1.777	9.14	5.217	5.398	5.212	0.742	2.29	-4.073	1.629	-8.778
-1.762	9.146	5.208	5.395	5.2	0.739	2.318	-4.08	1.631	-8.801
-1.762	9.141	5.191	5.375	5.18	0.713	2.316	-4.105	1.651	-8.798
-1.775	9.14	5.234	5.365	5.171	0.709	2.349	-4.105	1.658	-8.822

Annex A

-1.76	9.147	5.281	5.358	5.185	0.695	2.36	-4.129	1.645	-8.833
-1.774	9.14	5.289	5.333	5.162	0.676	2.344	-4.137	1.666	-8.841
-1.766	9.142	5.297	5.335	5.199	0.679	2.373	-4.144	1.646	-8.868
-1.764	9.143	5.277	5.318	5.223	0.654	2.347	-4.174	1.63	-8.868
-1.775	9.14	5.227	5.297	5.201	0.64	2.327	-4.176	1.626	-8.882
-1.764	9.147	5.249	5.298	5.217	0.64	2.329	-4.188	1.622	-8.904
-1.725	9.144	5.255	5.276	5.198	0.614	2.338	-4.208	1.62	-8.907
-1.518	9.135	5.262	5.268	5.175	0.61	2.37	-4.213	1.626	-8.93
-1.359	9.146	5.293	5.256	5.145	0.595	2.369	-4.233	1.649	-8.934
-1.16	9.139	5.288	5.234	5.129	0.573	2.35	-4.241	1.654	-8.945
-0.929	9.135	5.306	5.238	5.154	0.573	2.338	-4.251	1.63	-8.972
-0.713	9.141	5.291	5.215	5.161	0.549	2.317	-4.277	1.625	-8.971
-0.554	9.133	5.251	5.198	5.15	0.54	2.326	-4.279	1.615	-8.989
-0.438	9.136	5.251	5.194	5.156	0.536	2.339	-4.295	1.573	-9.003
-0.292	9.138	5.245	5.174	5.125	0.506	2.31	-4.309	1.591	-9.006
-0.178	9.126	5.226	5.169	5.106	0.504	2.317	-4.313	1.589	-9.029
-0.036	9.141	5.24	5.153	5.082	0.489	2.307	-4.333	1.603	-9.034
0.104	9.132	5.242	5.134	5.054	0.469	2.296	-4.342	1.624	-9.049
0.234	9.127	5.276	5.134	5.06	0.465	2.337	-4.35	1.626	-9.068
0.403	9.136	5.282	5.116	5.05	0.439	2.299	-4.377	1.639	-9.066
0.536	9.126	5.243	5.096	5.066	0.436	2.296	-4.375	1.623	-9.091
0.658	9.13	5.256	5.094	5.078	0.425	2.306	-4.397	1.596	-9.104
0.779	9.13	5.265	5.07	5.067	0.4	2.286	-4.41	1.628	-9.111
0.923	9.123	5.276	5.068	5.067	0.399	2.289	-4.413	1.589	-9.131
1.128	9.131	5.287	5.056	5.071	0.38	2.281	-4.443	1.595	-9.135
1.325	9.123	5.24	5.037	5.041	0.367	2.272	-4.441	1.605	-9.149
1.445	9.118	5.223	5.034	5.038	0.362	2.252	-4.461	1.574	-9.172
1.596	9.127	5.197	5.009	4.994	0.34	2.234	-4.477	1.589	-9.17
1.711	9.113	5.192	5.001	4.982	0.334	2.277	-4.479	1.588	-9.197
1.816	9.123	5.233	4.994	4.959	0.319	2.274	-4.504	1.571	-9.207
1.785	9.123	5.224	4.97	4.937	0.295	2.266	-4.51	1.578	-9.21
1.723	9.112	5.238	4.968	4.969	0.3	2.287	-4.518	1.564	-9.235
1.705	9.123	5.254	4.953	4.977	0.276	2.261	-4.545	1.596	-9.236
1.699	9.118	5.22	4.933	4.967	0.262	2.227	-4.548	1.591	-9.257
1.669	9.113	5.197	4.929	4.966	0.256	2.231	-4.569	1.574	-9.273
1.685	9.123	5.188	4.904	4.951	0.233	2.22	-4.581	1.591	-9.273
1.691	9.108	5.192	4.896	4.949	0.229	2.23	-4.585	1.591	-9.296
1.86	9.12	5.214	4.888	4.952	0.214	2.225	-4.61	1.589	-9.302
2.115	9.118	5.23	4.864	4.901	0.195	2.222	-4.612	1.586	-9.315
2.268	9.106	5.244	4.865	4.905	0.196	2.26	-4.625	1.578	-9.34
2.446	9.116	5.239	4.848	4.901	0.167	2.256	-4.652	1.589	-9.337

Annex A

2.625	9.108	5.227	4.827	4.897	0.16	2.268	-4.651	1.589	-9.357
2.773	9.105	5.223	4.822	4.887	0.152	2.242	-4.67	1.591	-9.372
2.943	9.112	5.229	4.803	4.862	0.127	2.241	-4.683	1.606	-9.376
3.099	9.1	5.249	4.797	4.867	0.123	2.242	-4.69	1.588	-9.397
3.308	9.104	5.249	4.785	4.852	0.103	2.243	-4.709	1.574	-9.397
3.503	9.103	5.229	4.762	4.816	0.086	2.235	-4.708	1.588	-9.414
3.659	9.088	5.263	4.764	4.826	0.084	2.234	-4.724	1.553	-9.438
3.802	9.099	5.277	4.746	4.786	0.059	2.21	-4.747	1.574	-9.439
3.95	9.091	5.262	4.726	4.724	0.052	2.197	-4.747	1.578	-9.462
4.082	9.085	5.283	4.725	4.716	0.038	2.206	-4.77	1.583	-9.471
4.256	9.093	5.264	4.701	4.725	0.016	2.218	-4.778	1.586	-9.476
4.407	9.076	5.28	4.695	4.739	0.014	2.243	-4.785	1.581	-9.504
4.564	9.082	5.285	4.684	4.72	-0.005	2.227	-4.812	1.565	-9.502
4.716	9.079	5.264	4.667	4.709	-0.018	2.239	-4.813	1.571	-9.524
4.824	9.064	5.284	4.668	4.708	-0.021	2.211	-4.832	1.554	-9.539
4.962	9.075	5.275	4.641	4.69	-0.047	2.176	-4.849	1.559	-9.54
5.093	9.065	5.267	4.629	4.692	-0.052	2.188	-4.852	1.567	-9.562
5.197	9.058	5.279	4.626	4.695	-0.063	2.181	-4.877	1.584	-9.567
5.339	9.063	5.249	4.603	4.688	-0.09	2.158	-4.883	1.576	-9.579
5.45	9.047	5.237	4.596	4.7	-0.089	2.186	-4.892	1.581	-9.602
5.571	9.05	5.251	4.582	4.68	-0.11	2.201	-4.913	1.588	-9.603
5.66	9.047	5.242	4.565	4.678	-0.12	2.222	-4.918	1.571	-9.622
5.738	9.034	5.244	4.56	4.704	-0.126	2.221	-4.941	1.548	-9.639
5.847	9.042	5.254	4.537	4.688	-0.156	2.205	-4.95	1.593	-9.639
5.939	9.029	5.26	4.528	4.683	-0.155	2.212	-4.957	1.601	-9.666
6.022	9.023	5.24	4.522	4.67	-0.172	2.191	-4.981	1.583	-9.67
6.118	9.031	5.215	4.497	4.639	-0.193	2.162	-4.986	1.579	-9.683
6.187	9.01	5.25	4.495	4.663	-0.19	2.152	-4.995	1.556	-9.702
6.277	9.016	5.226	4.481	4.663	-0.215	2.147	-5.018	1.566	-9.708
6.379	9.009	5.184	4.46	4.666	-0.223	2.194	-5.023	1.544	-9.728
6.436	9.001	5.16	4.455	4.669	-0.236	2.192	-5.045	1.536	-9.738
6.535	9.005	5.121	4.432	4.653	-0.257	2.19	-5.05	1.57	-9.743
6.634	8.988	5.142	4.426	4.646	-0.26	2.222	-5.058	1.556	-9.768
6.712	8.987	5.159	4.414	4.617	-0.281	2.206	-5.085	1.56	-9.767
6.811	8.99	5.154	4.393	4.586	-0.296	2.209	-5.082	1.57	-9.787
6.863	8.972	5.168	4.392	4.605	-0.297	2.22	-5.102	1.539	-9.801
6.928	8.976	5.172	4.374	4.605	-0.323	2.232	-5.116	1.556	-9.804
7.012	8.967	5.167	4.359	4.591	-0.332	2.263	-5.117	1.569	-9.823
7.068	8.956	5.185	4.355	4.602	-0.34	2.256	-5.144	1.572	-9.832
7.169	8.957	5.202	4.331	4.575	-0.365	2.26	-5.149	1.592	-9.844
7.228	8.938	5.216	4.33	4.574	-0.366	2.256	-5.166	1.589	-9.867

Annex A

7.281	8.935	5.251	4.314	4.579	-0.387	2.247	-5.183	1.589	-9.865
7.327	8.933	5.256	4.297	4.577	-0.395	2.261	-5.184	1.587	-9.885
7.326	8.911	5.255	4.294	4.611	-0.401	2.218	-5.21	1.573	-9.904
7.349	8.911	5.262	4.274	4.605	-0.43	2.204	-5.22	1.578	-9.907
7.362	8.899	5.258	4.264	4.594	-0.43	2.154	-5.228	1.576	-9.926
7.334	8.881	5.242	4.253	4.578	-0.443	2.14	-5.25	1.582	-9.928
7.304	8.877	5.224	4.235	4.55	-0.464	2.138	-5.251	1.571	-9.949
7.244	8.851	5.226	4.229	4.567	-0.465	2.14	-5.272	1.547	-9.967
7.21	8.846	5.219	4.213	4.567	-0.49	2.112	-5.287	1.57	-9.967
7.205	8.836	5.199	4.193	4.565	-0.495	2.129	-5.29	1.567	-9.99
7.183	8.813	5.205	4.191	4.579	-0.507	2.108	-5.313	1.57	-10
7.19	8.816	5.208	4.168	4.537	-0.534	2.105	-5.317	1.561	-10.009
7.221	8.797	5.205	4.158	4.539	-0.532	2.137	-5.333	1.529	-10.03
7.209	8.781	5.236	4.152	4.539	-0.549	2.134	-5.351	1.542	-10.034
7.216	8.783	5.217	4.128	4.534	-0.567	2.145	-5.354	1.555	-10.053
7.185	8.76	5.228	4.125	4.534	-0.572	2.138	-5.375	1.525	-10.067
7.151	8.749	5.215	4.105	4.503	-0.593	2.137	-5.385	1.536	-10.067
7.152	8.744	5.197	4.091	4.509	-0.601	2.143	-5.389	1.552	-10.094
7.113	8.719	5.251	4.092	4.506	-0.612	2.125	-5.416	1.555	-10.101
7.117	8.724	5.251	4.066	4.471	-0.636	2.138	-5.42	1.577	-10.107
7.115	8.7	5.255	4.061	4.484	-0.635	2.165	-5.431	1.566	-10.132
7.086	8.687	5.275	4.049	4.485	-0.654	2.15	-5.451	1.563	-10.136
7.075	8.687	5.251	4.029	4.467	-0.671	2.161	-5.456	1.553	-10.154
7.063	8.662	5.271	4.028	4.493	-0.675	2.142	-5.476	1.549	-10.165
7.071	8.66	5.299	4.005	4.485	-0.701	2.159	-5.484	1.574	-10.167
7.068	8.648	5.294	3.996	4.48	-0.703	2.179	-5.492	1.528	-10.196
7.038	8.625	5.306	3.987	4.447	-0.718	2.169	-5.518	1.521	-10.197
7.028	8.623	5.29	3.965	4.411	-0.738	2.186	-5.516	1.519	-10.214
7.011	8.601	5.31	3.963	4.431	-0.741	2.203	-5.536	1.508	-10.234
6.983	8.592	5.326	3.949	4.401	-0.764	2.2	-5.552	1.525	-10.237
6.974	8.592	5.317	3.924	4.396	-0.775	2.211	-5.553	1.518	-10.257
6.934	8.567	5.334	3.928	4.416	-0.779	2.196	-5.578	1.516	-10.264
6.91	8.562	5.334	3.908	4.388	-0.805	2.168	-5.585	1.528	-10.273
6.892	8.551	5.311	3.894	4.387	-0.805	2.171	-5.6	1.511	-10.297
6.847	8.53	5.311	3.89	4.383	-0.823	2.139	-5.621	1.517	-10.3
6.813	8.529	5.263	3.866	4.359	-0.842	2.111	-5.622	1.519	-10.319
6.758	8.503	5.272	3.864	4.374	-0.843	2.105	-5.643	1.51	-10.336
6.704	8.493	5.287	3.846	4.36	-0.873	2.094	-5.659	1.53	-10.338
6.668	8.488	5.285	3.825	4.344	-0.876	2.097	-5.664	1.53	-10.358
6.573	8.459	5.317	3.826	4.333	-0.886	2.078	-5.689	1.527	-10.37
6.518	8.454	5.31	3.807	4.31	-0.914	2.067	-5.696	1.541	-10.376

Annex A

6.491	8.442	5.305	3.795	4.3	-0.911	2.055	-5.715	1.523	-10.401
6.434	8.419	5.31	3.786	4.284	-0.934	2.047	-5.729	1.551	-10.401
6.41	8.419	5.31	3.761	4.27	-0.947	2.067	-5.73	1.537	-10.424
6.369	8.392	5.333	3.764	4.294	-0.954	2.062	-5.753	1.513	-10.438
6.329	8.386	5.351	3.742	4.29	-0.978	2.041	-5.765	1.523	-10.439
6.325	8.379	5.347	3.73	4.258	-0.981	2.068	-5.77	1.501	-10.462
6.302	8.352	5.358	3.727	4.281	-0.995	2.07	-5.796	1.516	-10.468
6.289	8.352	5.36	3.701	4.244	-1.019	2.075	-5.798	1.522	-10.483
6.272	8.334	5.366	3.698	4.224	-1.017	2.06	-5.813	1.506	-10.502
6.197	8.317	5.359	3.682	4.214	-1.039	2.034	-5.835	1.513	-10.504
6.163	8.317	5.326	3.662	4.196	-1.054	2.056	-5.834	1.513	-10.527
6.114	8.291	5.311	3.66	4.183	-1.062	2.041	-5.861	1.516	-10.537
6.071	8.282	5.305	3.636	4.116	-1.086	2.031	-5.866	1.535	-10.54
6.042	8.276	5.285	3.628	4.112	-1.088	2.038	-5.876	1.516	-10.562
5.997	8.249	5.312	3.618	4.106	-1.106	2.026	-5.9	1.514	-10.566
6.01	8.248	5.33	3.598	4.068	-1.129	2.039	-5.896	1.519	-10.583
5.999	8.229	5.324	3.595	4.063	-1.13	2.053	-5.912	1.513	-10.599
5.952	8.211	5.31	3.58	4.056	-1.152	2.058	-5.931	1.529	-10.6
5.948	8.213	5.28	3.556	4.045	-1.164	2.078	-5.936	1.527	-10.621
5.929	8.187	5.289	3.555	4.052	-1.172	2.057	-5.958	1.546	-10.628
5.906	8.181	5.267	3.534	4.016	-1.193	2.067	-5.963	1.559	-10.638
5.902	8.172	5.247	3.522	4.019	-1.193	2.081	-5.978	1.536	-10.662
5.86	8.151	5.263	3.513	4.013	-1.213	2.066	-5.999	1.521	-10.665
5.86	8.152	5.247	3.494	4.005	-1.227	2.072	-5.998	1.524	-10.682
5.851	8.129	5.251	3.494	4.005	-1.231	2.053	-6.018	1.518	-10.704
5.847	8.115	5.253	3.476	3.976	-1.258	2.052	-6.035	1.537	-10.701
5.846	8.117	5.265	3.458	3.963	-1.264	2.074	-6.041	1.519	-10.725
5.82	8.089	5.266	3.456	3.967	-1.276	2.048	-6.062	1.506	-10.73
5.815	8.079	5.261	3.432	3.947	-1.299	2.043	-6.066	1.511	-10.743
5.806	8.07	5.247	3.425	3.964	-1.303	2.048	-6.082	1.504	-10.766
5.772	8.048	5.274	3.414	3.959	-1.322	2.024	-6.102	1.515	-10.767
5.795	8.049	5.262	3.394	3.946	-1.335	2.035	-6.099	1.524	-10.786
5.805	8.03	5.272	3.395	3.929	-1.341	2.039	-6.128	1.507	-10.802
5.798	8.014	5.263	3.372	3.899	-1.368	2.019	-6.135	1.52	-10.806
5.809	8.014	5.242	3.355	3.884	-1.371	2.026	-6.147	1.512	-10.829
5.784	7.985	5.239	3.351	3.911	-1.385	1.995	-6.171	1.517	-10.835
5.758	7.981	5.227	3.331	3.88	-1.405	1.998	-6.17	1.523	-10.851
5.624	7.965	5.229	3.321	3.886	-1.408	2.012	-6.187	1.505	-10.868
5.542	7.94	5.232	3.309	3.853	-1.428	2.007	-6.203	1.522	-10.865
5.581	7.94	5.217	3.291	3.841	-1.44	2.023	-6.206	1.52	-10.889
5.605	7.917	5.264	3.29	3.846	-1.448	2.006	-6.235	1.505	-10.904

Annex A

5.598	7.906	5.278	3.266	3.804	-1.474	1.98	-6.237	1.519	-10.907
5.612	7.9	5.255	3.256	3.785	-1.473	1.999	-6.248	1.501	-10.934
5.572	7.875	5.266	3.248	3.768	-1.491	1.96	-6.269	1.525	-10.937
5.56	7.871	5.248	3.224	3.757	-1.513	1.973	-6.269	1.523	-10.95
5.543	7.857	5.248	3.222	3.774	-1.516	1.962	-6.29	1.501	-10.965
5.468	7.838	5.259	3.206	3.765	-1.535	1.951	-6.302	1.533	-10.966
5.452	7.833	5.248	3.189	3.752	-1.544	1.973	-6.308	1.535	-10.991
5.443	7.81	5.231	3.183	3.755	-1.555	1.953	-6.337	1.533	-11
5.423	7.8	5.214	3.16	3.718	-1.578	1.953	-6.334	1.535	-11.007
5.425	7.795	5.216	3.153	3.713	-1.573	1.958	-6.353	1.538	-11.031
5.388	7.775	5.242	3.145	3.685	-1.594	1.952	-6.373	1.546	-11.034
5.411	7.772	5.239	3.12	3.685	-1.612	1.982	-6.369	1.547	-11.051
5.444	7.758	5.233	3.12	3.698	-1.614	1.995	-6.393	1.544	-11.065
5.452	7.736	5.23	3.106	3.677	-1.638	2.007	-6.403	1.569	-11.07
5.458	7.736	5.226	3.093	3.666	-1.644	2.037	-6.411	1.533	-11.097
5.424	7.712	5.252	3.087	3.669	-1.658	2.039	-6.435	1.55	-11.1
5.422	7.702	5.245	3.063	3.644	-1.678	2.051	-6.434	1.577	-11.112
5.448	7.697	5.258	3.06	3.652	-1.678	2.042	-6.454	1.559	-11.134
5.44	7.673	5.28	3.047	3.645	-1.702	2.026	-6.471	1.538	-11.132
5.469	7.673	5.269	3.024	3.615	-1.715	2.032	-6.469	1.559	-11.152
5.459	7.655	5.283	3.025	3.619	-1.718	1.99	-6.499	1.564	-11.165
5.404	7.634	5.277	3.001	3.59	-1.744	1.995	-6.504	1.576	-11.171
5.407	7.634	5.282	2.99	3.585	-1.748	2.001	-6.518	1.579	-11.198
5.37	7.607	5.318	2.985	3.566	-1.76	1.981	-6.537	1.604	-11.198
5.362	7.597	5.315	2.961	3.531	-1.78	2.006	-6.535	1.626	-11.213
5.364	7.59	5.302	2.961	3.536	-1.782	2.019	-6.557	1.583	-11.234
5.326	7.567	5.32	2.943	3.504	-1.811	2.014	-6.57	1.593	-11.232
5.335	7.569	5.291	2.923	3.48	-1.819	2.017	-6.572	1.591	-11.255
5.317	7.543	5.312	2.923	3.475	-1.828	2.016	-6.599	1.6	-11.264
5.308	7.53	5.303	2.898	3.423	-1.854	2.016	-6.6	1.618	-11.272
5.32	7.528	5.297	2.885	3.403	-1.856	2.021	-6.622	1.628	-11.293
5.288	7.503	5.307	2.88	3.379	-1.873	1.993	-6.634	1.631	-11.296
5.279	7.496	5.279	2.859	3.352	-1.893	2.006	-6.636	1.646	-11.316
5.271	7.485	5.281	2.854	3.368	-1.9	1.995	-6.662	1.634	-11.33
5.241	7.464	5.264	2.834	3.321	-1.922	1.993	-6.667	1.652	-11.327
5.236	7.461	5.256	2.82	3.313	-1.926	2.021	-6.675	1.628	-11.352
5.216	7.439	5.301	2.821	3.294	-1.94	2.001	-6.698	1.639	-11.359
5.208	7.428	5.3	2.796	3.273	-1.961	1.987	-6.701	1.653	-11.367
5.239	7.424	5.281	2.784	3.248	-1.961	1.992	-6.72	1.639	-11.392
5.216	7.404	5.298	2.778	3.236	-1.983	1.952	-6.735	1.648	-11.393
5.213	7.401	5.28	2.755	3.238	-1.999	1.968	-6.739	1.659	-11.414

Annex A

5.218	7.389	5.285	2.755	3.254	-2.003	1.966	-6.765	1.645	-11.422
5.193	7.363	5.274	2.728	3.245	-2.024	1.981	-6.766	1.663	-11.427
5.192	7.363	5.264	2.723	3.25	-2.031	2	-6.78	1.66	-11.454
5.196	7.343	5.284	2.716	3.233	-2.048	1.991	-6.804	1.674	-11.456
5.191	7.33	5.27	2.691	3.207	-2.069	2.011	-6.801	1.679	-11.469
5.2	7.326	5.272	2.688	3.214	-2.068	2.015	-6.825	1.663	-11.49
5.183	7.301	5.286	2.674	3.217	-2.09	1.995	-6.837	1.678	-11.493
5.188	7.301	5.287	2.656	3.197	-2.103	1.998	-6.84	1.659	-11.516
5.188	7.281	5.309	2.654	3.195	-2.108	1.974	-6.868	1.633	-11.526
5.16	7.263	5.273	2.631	3.172	-2.132	1.974	-6.868	1.617	-11.532
5.153	7.263	5.256	2.621	3.18	-2.134	1.989	-6.887	1.622	-11.559
5.141	7.241	5.284	2.612	3.168	-2.156	1.978	-6.909	1.606	-11.558
5.143	7.228	5.266	2.589	3.155	-2.17	1.983	-6.907	1.621	-11.575
5.17	7.221	5.281	2.59	3.165	-2.171	1.975	-6.935	1.608	-11.591
5.17	7.2	5.28	2.572	3.174	-2.198	1.939	-6.941	1.623	-11.593
5.184	7.198	5.269	2.549	3.166	-2.204	1.946	-6.954	1.613	-11.619
5.154	7.179	5.28	2.548	3.19	-2.213	1.915	-6.974	1.633	-11.625
5.085	7.159	5.273	2.526	3.178	-2.236	1.911	-6.977	1.632	-11.636
5.071	7.159	5.294	2.517	3.17	-2.239	1.896	-6.996	1.613	-11.658
5.064	7.137	5.308	2.508	3.163	-2.26	1.873	-7.01	1.642	-11.656
5.021	7.124	5.293	2.488	3.127	-2.274	1.908	-7.01	1.631	-11.679
5.033	7.119	5.323	2.491	3.117	-2.281	1.891	-7.039	1.617	-11.689
5.015	7.095	5.316	2.468	3.093	-2.306	1.868	-7.044	1.637	-11.693
5.056	7.093	5.304	2.448	3.094	-2.308	1.876	-7.052	1.625	-11.719
5.085	7.076	5.304	2.448	3.11	-2.322	1.871	-7.077	1.623	-11.719
5.071	7.059	5.296	2.423	3.107	-2.342	1.896	-7.078	1.642	-11.734
5.083	7.061	5.273	2.418	3.128	-2.345	1.898	-7.097	1.623	-11.75
5.08	7.034	5.272	2.402	3.13	-2.364	1.89	-7.113	1.65	-11.75
5.087	7.025	5.236	2.384	3.099	-2.372	1.895	-7.114	1.628	-11.776
5.093	7.018	5.237	2.383	3.112	-2.379	1.882	-7.143	1.617	-11.786
5.056	6.998	5.23	2.357	3.078	-2.406	1.883	-7.144	1.631	-11.793
5.075	6.995	5.208	2.349	3.079	-2.41	1.902	-7.157	1.611	-11.819
5.079	6.976	5.241	2.344	3.064	-2.427	1.886	-7.181	1.622	-11.82
5.062	6.964	5.237	2.321	3.034	-2.447	1.896	-7.177	1.616	-11.837
5.042	6.959	5.246	2.316	3.035	-2.447	1.891	-7.206	1.598	-11.854
5.024	6.935	5.267	2.3	3.017	-2.473	1.87	-7.213	1.639	-11.857
5.026	6.93	5.241	2.286	3.018	-2.478	1.879	-7.222	1.625	-11.88
5.044	6.918	5.253	2.282	3.027	-2.489	1.866	-7.248	1.605	-11.887
5.026	6.894	5.273	2.257	3.017	-2.516	1.873	-7.245	1.614	-11.898
5.008	6.894	5.276	2.25	3.024	-2.514	1.862	-7.268	1.59	-11.921
5.011	6.874	5.304	2.244	3.001	-2.534	1.865	-7.281	1.595	-11.923

Annex A

5.027	6.859	5.293	2.216	2.965	-2.553	1.889	-7.281	1.586	-11.942
5.054	6.857	5.297	2.217	2.958	-2.556	1.863	-7.312	1.554	-11.955
5.037	6.831	5.296	2.197	2.943	-2.578	1.882	-7.314	1.571	-11.965
5.041	6.83	5.292	2.183	2.939	-2.588	1.889	-7.325	1.567	-11.985
5.082	6.816	5.302	2.179	2.946	-2.6	1.891	-7.345	1.58	-11.989
5.074	6.797	5.299	2.154	2.929	-2.623	1.913	-7.344	1.584	-12.004
5.083	6.796	5.287	2.15	2.942	-2.621	1.911	-7.369	1.588	-12.022
5.062	6.773	5.304	2.139	2.921	-2.645	1.889	-7.38	1.62	-12.022
5.058	6.763	5.283	2.117	2.88	-2.658	1.9	-7.386	1.611	-12.045
5.07	6.753	5.313	2.118	2.892	-2.663	1.889	-7.411	1.589	-12.054
5.033	6.73	5.307	2.095	2.895	-2.685	1.896	-7.413	1.596	-12.063
5.035	6.728	5.296	2.083	2.906	-2.689	1.886	-7.43	1.568	-12.088
5.062	6.713	5.293	2.074	2.912	-2.706	1.854	-7.446	1.571	-12.085
5.058	6.695	5.285	2.051	2.886	-2.723	1.869	-7.447	1.577	-12.106
5.049	6.694	5.289	2.051	2.899	-2.728	1.874	-7.475	1.554	-12.121
5.004	6.668	5.296	2.034	2.875	-2.749	1.863	-7.479	1.572	-12.121
4.992	6.656	5.277	2.013	2.827	-2.758	1.86	-7.486	1.563	-12.147
4.99	6.65	5.294	2.014	2.804	-2.765	1.826	-7.515	1.563	-12.151
4.987	6.626	5.266	1.986	2.791	-2.791	1.825	-7.512	1.554	-12.159
5.021	6.628	5.246	1.979	2.772	-2.794	1.804	-7.535	1.533	-12.185
5.034	6.608	5.252	1.969	2.745	-2.812	1.791	-7.549	1.547	-12.188
5.02	6.593	5.255	1.948	2.708	-2.831	1.817	-7.554	1.552	-12.209
4.982	6.589	5.252	1.946	2.658	-2.834	1.807	-7.584	1.522	-12.215
4.944	6.562	5.273	1.932	2.622	-2.862	1.814	-7.584	1.554	-12.219
4.951	6.556	5.263	1.914	2.558	-2.869	1.841	-7.596	1.562	-12.25
4.968	6.548	5.268	1.91	2.562	-2.881	1.839	-7.617	1.573	-12.249
4.949	6.525	5.245	1.888	2.481	-2.912	1.848	-7.619	1.562	-12.265
4.965	6.523	5.23	1.878	2.479	-2.911	1.841	-7.639	1.54	-12.282
4.967	6.501	5.228	1.869	2.418	-2.935	1.834	-7.648	1.552	-12.285
4.931	6.485	5.209	1.848	2.376	-2.949	1.833	-7.658	1.534	-12.309
4.944	6.485	5.22	1.847	2.381	-2.959	1.786	-7.685	1.525	-12.316
4.937	6.458	5.226	1.824	2.286	-2.981	1.769	-7.685	1.529	-12.323
4.915	6.452	5.233	1.811	2.308	-2.987	1.782	-7.702	1.49	-12.351
4.938	6.44	5.264	1.808	2.38	-3.004	1.779	-7.724	1.485	-12.35
4.937	6.418	5.257	1.784	2.402	-3.026	1.796	-7.72	1.484	-12.37
4.926	6.42	5.271	1.778	2.43	-3.023	1.801	-7.744	1.482	-12.384
4.932	6.399	5.284	1.766	2.445	-3.047	1.803	-7.754	1.509	-12.39
4.955	6.386	5.273	1.744	2.435	-3.057	1.826	-7.762	1.504	-12.41
4.973	6.382	5.283	1.744	2.459	-3.063	1.804	-7.786	1.516	-12.416
4.949	6.356	5.277	1.719	2.464	-3.087	1.82	-7.781	1.537	-12.429
4.973	6.351	5.26	1.712	2.484	-3.09	1.84	-7.803	1.489	-12.45

Annex A

5.02	6.34	5.269	1.703	2.495	-3.105	1.821	-7.819	1.495	-12.452
5.035	6.321	5.261	1.681	2.496	-3.125	1.829	-7.818	1.493	-12.469
5.048	6.32	5.297	1.681	2.52	-3.119	1.82	-7.848	1.491	-12.483
5.032	6.299	5.326	1.664	2.504	-3.143	1.815	-7.851	1.501	-12.491
5.014	6.287	5.303	1.644	2.493	-3.151	1.813	-7.862	1.47	-12.511
5.032	6.28	5.279	1.644	2.495	-3.16	1.795	-7.886	1.47	-12.509
5.002	6.258	5.249	1.617	2.473	-3.183	1.796	-7.886	1.477	-12.527
4.988	6.256	5.235	1.61	2.497	-3.185	1.783	-7.913	1.471	-12.544
5.009	6.24	5.272	1.599	2.499	-3.205	1.765	-7.919	1.467	-12.544
4.972	6.22	5.271	1.58	2.503	-3.218	1.773	-7.924	1.469	-12.569
5.009	6.224	5.302	1.58	2.508	-3.224	1.758	-7.957	1.455	-12.577
5.021	6.204	5.312	1.554	2.479	-3.246	1.792	-7.952	1.491	-12.589
5.032	6.196	5.317	1.546	2.488	-3.254	1.814	-7.968	1.493	-12.612
5.05	6.186	5.347	1.547	2.491	-3.266	1.796	-7.989	1.501	-12.613
5.014	6.164	5.344	1.521	2.489	-3.288	1.801	-7.992	1.51	-12.627
5.034	6.163	5.343	1.516	2.499	-3.291	1.786	-8.014	1.495	-12.644
5.049	6.144	5.349	1.504	2.499	-3.31	1.772	-8.023	1.504	-12.649
5.012	6.125	5.321	1.485	2.492	-3.323	1.78	-8.033	1.493	-12.672
5.005	6.125	5.346	1.481	2.529	-3.328	1.756	-8.061	1.481	-12.675
5.022	6.103	5.335	1.459	2.503	-3.352	1.753	-8.056	1.502	-12.69
5.038	6.097	5.303	1.447	2.498	-3.358	1.759	-8.074	1.498	-12.712
5.058	6.086	5.297	1.444	2.501	-3.371	1.717	-8.094	1.509	-12.712
5.083	6.063	5.293	1.419	2.497	-3.39	1.701	-8.099	1.504	-12.734
5.113	6.063	5.322	1.414	2.503	-3.393	1.695	-8.127	1.489	-12.747
5.123	6.044	5.338	1.401	2.508	-3.414	1.681	-8.128		

Table 13. Tensile Trial 7 Results.

F (Kg)	D (mm)	F (Kg)	D (mm)	F (Kg)	D (mm)	F (Kg)	D (mm)	F (Kg)	D (mm)
-0.024	18.75	1.497	16.483	1.898	11.691	1.628	4.667	1.098	-2.45
-0.012	18.755	1.499	16.478	1.886	11.685	1.629	4.66	1.106	-2.474
-0.022	18.747	1.488	16.465	1.866	11.673	1.597	4.638	1.122	-2.483
-0.027	18.754	1.492	16.462	1.853	11.655	1.605	4.629	1.135	-2.492
-0.016	18.754	1.494	16.455	1.859	11.651	1.625	4.619	1.114	-2.514
-0.026	18.747	1.492	16.447	1.842	11.63	1.617	4.597	1.129	-2.517
-0.022	18.754	1.497	16.447	1.83	11.613	1.624	4.595	1.15	-2.532
-0.01	18.752	1.494	16.436	1.859	11.613	1.63	4.576	1.15	-2.555
-0.027	18.746	1.492	16.428	1.859	11.591	1.607	4.557	1.133	-2.555
-0.018	18.756	1.498	16.428	1.851	11.581	1.616	4.558	1.121	-2.575
-0.009	18.753	1.498	16.412	1.863	11.575	1.618	4.538	1.112	-2.593

Annex A

-0.029	18.749	1.484	16.413	1.856	11.554	1.597	4.521	1.134	-2.596
-0.011	18.755	1.485	16.407	1.869	11.545	1.587	4.517	1.154	-2.616
-0.02	18.748	1.468	16.391	1.9	11.534	1.545	4.494	1.138	-2.63
-0.026	18.752	1.466	16.396	1.906	11.515	1.533	4.485	1.144	-2.635
-0.016	18.756	1.442	16.389	1.937	11.514	1.561	4.476	1.121	-2.656
-0.022	18.747	1.433	16.379	1.953	11.498	1.547	4.451	1.109	-2.667
-0.026	18.751	1.426	16.378	1.944	11.478	1.567	4.449	1.116	-2.676
-0.016	18.756	1.418	16.367	1.944	11.475	1.602	4.437	1.104	-2.696
-0.022	18.747	1.403	16.359	1.968	11.454	1.587	4.413	1.127	-2.703
-0.019	18.752	1.409	16.36	1.96	11.438	1.604	4.413	1.153	-2.715
-0.019	18.753	1.396	16.346	1.983	11.437	1.626	4.394	1.138	-2.736
-0.021	18.748	1.394	16.342	1.993	11.414	1.613	4.376	1.164	-2.735
-0.013	18.754	1.4	16.343	1.977	11.405	1.627	4.375	1.175	-2.752
-0.018	18.751	1.37	16.326	1.995	11.403	1.633	4.359	1.172	-2.768
-0.027	18.748	1.368	16.321	1.975	11.378	1.615	4.339	1.187	-2.769
-0.015	18.756	1.359	16.32	1.956	11.368	1.625	4.339	1.204	-2.787
-0.016	18.749	1.355	16.305	1.962	11.359	1.602	4.316	1.213	-2.802
-0.03	18.749	1.348	16.303	1.932	11.339	1.579	4.301	1.221	-2.807
-0.017	18.757	1.352	16.296	1.934	11.333	1.565	4.297	1.201	-2.833
-0.016	18.748	1.322	16.286	1.915	11.317	1.531	4.275	1.189	-2.839
-0.025	18.751	1.321	16.289	1.877	11.303	1.51	4.27	1.195	-2.85
-0.014	18.755	1.327	16.278	1.893	11.303	1.517	4.259	1.179	-2.875
-0.024	18.747	1.312	16.267	1.905	11.281	1.499	4.234	1.192	-2.875
-0.018	18.753	1.316	16.271	1.883	11.263	1.502	4.232	1.207	-2.888
-0.022	18.754	1.321	16.259	1.879	11.262	1.521	4.22	1.202	-2.912
-0.028	18.747	1.313	16.248	1.857	11.244	1.513	4.197	1.208	-2.914
-0.013	18.755	1.333	16.249	1.848	11.23	1.505	4.192	1.208	-2.931
-0.013	18.752	1.332	16.238	1.87	11.226	1.509	4.178	1.177	-2.947
-0.033	18.748	1.344	16.233	1.857	11.204	1.512	4.162	1.164	-2.954
-0.013	18.756	1.353	16.229	1.871	11.196	1.54	4.157	1.158	-2.973
-0.013	18.75	1.34	16.216	1.901	11.186	1.562	4.135	1.15	-2.986
-0.032	18.748	1.362	16.215	1.874	11.161	1.569	4.126	1.171	-2.99
-0.016	18.757	1.378	16.211	1.908	11.16	1.596	4.121	1.163	-3.014
-0.018	18.749	1.378	16.197	1.927	11.147	1.587	4.095	1.144	-3.022
-0.03	18.749	1.393	16.199	1.907	11.124	1.589	4.092	1.163	-3.029
-0.025	18.755	1.421	16.193	1.883	11.124	1.599	4.084	1.164	-3.053
-0.005	18.755	1.414	16.181	1.888	11.108	1.581	4.061	1.173	-3.055
-0.023	18.748	1.427	16.185	1.853	11.088	1.578	4.055	1.187	-3.07
-0.022	18.754	1.433	16.174	1.852	11.086	1.582	4.041	1.178	-3.091
-0.001	18.753	1.439	16.164	1.844	11.066	1.568	4.02	1.175	-3.093
-0.018	18.75	1.465	16.166	1.84	11.05	1.567	4.016	1.182	-3.113

Annex A

-0.016	18.756	1.464	16.152	1.873	11.045	1.566	3.997	1.151	-3.126
-0.008	18.749	1.483	16.147	1.872	11.024	1.522	3.98	1.159	-3.127
-0.024	18.749	1.509	16.145	1.863	11.017	1.527	3.977	1.146	-3.146
-0.006	18.759	1.498	16.133	1.892	11.007	1.516	3.954	1.118	-3.162
-0.021	18.747	1.512	16.133	1.886	10.986	1.499	3.939	1.131	-3.164
-0.023	18.75	1.526	16.129	1.885	10.98	1.479	3.937	1.114	-3.19
-0.008	18.758	1.505	16.111	1.922	10.969	1.475	3.914	1.112	-3.201
-0.009	18.748	1.496	16.115	1.926	10.945	1.466	3.905	1.119	-3.205
-0.015	18.752	1.512	16.108	1.945	10.945	1.498	3.899	1.106	-3.228
-0.002	18.752	1.502	16.098	1.949	10.934	1.488	3.875	1.117	-3.232
-0.021	18.749	1.493	16.095	1.9	10.915	1.487	3.872	1.114	-3.244
-0.021	18.755	1.485	16.089	1.915	10.911	1.479	3.858	1.082	-3.268
-0.007	18.753	1.497	16.077	1.913	10.893	1.457	3.839	1.081	-3.272
-0.019	18.748	1.515	16.077	1.885	10.878	1.47	3.834	1.098	-3.291
-0.013	18.754	1.52	16.064	1.887	10.874	1.476	3.816	1.078	-3.307
-0.005	18.751	1.521	16.061	1.873	10.851	1.462	3.802	1.095	-3.308
-0.018	18.748	1.55	16.06	1.864	10.841	1.479	3.8	1.095	-3.329
-0.012	18.755	1.543	16.044	1.876	10.838	1.476	3.777	1.105	-3.344
-0.006	18.75	1.549	16.041	1.884	10.811	1.46	3.76	1.111	-3.346
-0.021	18.752	1.574	16.041	1.879	10.805	1.464	3.761	1.117	-3.372
-0.003	18.755	1.581	16.026	1.893	10.796	1.465	3.737	1.108	-3.384
-0.019	18.75	1.585	16.025	1.885	10.773	1.455	3.728	1.117	-3.39
-0.021	18.752	1.609	16.019	1.88	10.769	1.474	3.719	1.102	-3.414
-0.004	18.754	1.61	16.009	1.877	10.753	1.474	3.696	1.1	-3.418
-0.017	18.746	1.621	16.01	1.847	10.736	1.479	3.691	1.115	-3.43
-0.01	18.754	1.627	16.003	1.865	10.734	1.487	3.677	1.102	-3.452
0.004	18.754	1.62	15.995	1.876	10.712	1.478	3.656	1.09	-3.455
-0.015	18.746	1.62	15.996	1.902	10.7	1.493	3.657	1.075	-3.475
-0.015	18.759	1.602	15.982	1.944	10.698	1.499	3.638	1.035	-3.492
-0.002	18.751	1.566	15.975	1.966	10.674	1.493	3.619	1.023	-3.496
-0.004	18.746	1.598	15.974	1.955	10.665	1.504	3.616	1.02	-3.514
0.001	18.757	1.584	15.96	1.98	10.658	1.511	3.599	1.013	-3.527
-0.004	18.749	1.58	15.96	1.979	10.634	1.479	3.584	1.038	-3.529
-0.013	18.751	1.58	15.955	1.973	10.631	1.479	3.577	1.034	-3.554
0.008	18.755	1.563	15.94	1.983	10.621	1.457	3.554	1.024	-3.565
-0.013	18.748	1.586	15.942	1.977	10.598	1.463	3.55	1.044	-3.568
-0.002	18.753	1.58	15.932	1.962	10.591	1.461	3.543	1.034	-3.594
0.017	18.755	1.577	15.922	1.952	10.578	1.455	3.514	1.031	-3.599
0.001	18.746	1.574	15.924	1.902	10.556	1.448	3.51	1.041	-3.61
0.006	18.755	1.551	15.911	1.893	10.554	1.45	3.502	1.017	-3.634
0.019	18.755	1.54	15.904	1.883	10.539	1.411	3.477	1.018	-3.635

Annex A

0.007	18.746	1.55	15.907	1.859	10.522	1.417	3.476	1.005	-3.654
0.005	18.755	1.552	15.889	1.866	10.521	1.441	3.464	0.984	-3.673
0.016	18.754	1.553	15.886	1.859	10.5	1.423	3.441	0.982	-3.675
0.008	18.751	1.569	15.889	1.854	10.486	1.418	3.44	0.968	-3.695
0.008	18.754	1.565	15.87	1.868	10.481	1.427	3.418	0.947	-3.712
0.012	18.75	1.579	15.869	1.867	10.457	1.423	3.403	0.944	-3.714
0.003	18.75	1.584	15.863	1.887	10.449	1.458	3.4	0.935	-3.736
0.026	18.758	1.569	15.853	1.921	10.443	1.444	3.376	0.941	-3.749
0.01	18.746	1.579	15.856	1.903	10.421	1.451	3.37	0.963	-3.756
0.009	18.75	1.573	15.842	1.903	10.418	1.493	3.363	0.954	-3.78
0.021	18.755	1.559	15.829	1.919	10.397	1.477	3.335	0.954	-3.785
0.015	18.747	1.568	15.834	1.88	10.38	1.475	3.331	0.985	-3.797
0.019	18.755	1.559	15.823	1.889	10.381	1.458	3.318	0.976	-3.822
0.027	18.752	1.529	15.81	1.91	10.36	1.449	3.296	0.995	-3.822
0.022	18.749	1.55	15.815	1.911	10.342	1.454	3.294	1.01	-3.834
0.019	18.754	1.546	15.802	1.921	10.342	1.467	3.281	0.991	-3.859
0.021	18.753	1.544	15.797	1.91	10.322	1.452	3.26	0.968	-3.859
0.028	18.748	1.559	15.796	1.878	10.307	1.466	3.258	0.955	-3.877
0.04	18.757	1.532	15.778	1.87	10.301	1.456	3.235	0.942	-3.895
0.03	18.75	1.532	15.782	1.867	10.278	1.433	3.221	0.943	-3.897
0.018	18.751	1.545	15.775	1.862	10.272	1.442	3.216	0.933	-3.922
0.048	18.758	1.525	15.763	1.879	10.262	1.413	3.192	0.939	-3.929
0.04	18.747	1.54	15.766	1.855	10.236	1.39	3.185	0.971	-3.937
0.045	18.751	1.553	15.757	1.857	10.234	1.4	3.178	0.939	-3.963
0.053	18.756	1.545	15.742	1.874	10.225	1.372	3.151	0.927	-3.965
0.055	18.747	1.54	15.748	1.871	10.198	1.366	3.146	0.947	-3.979
0.057	18.752	1.544	15.736	1.892	10.198	1.389	3.135	0.921	-4.005
0.074	18.754	1.53	15.726	1.917	10.184	1.39	3.113	0.917	-4.006
0.068	18.747	1.535	15.729	1.922	10.167	1.408	3.114	0.916	-4.02
0.073	18.753	1.536	15.716	1.934	10.166	1.421	3.102	0.859	-4.045
0.084	18.752	1.529	15.708	1.944	10.144	1.397	3.081	0.866	-4.047
0.085	18.749	1.541	15.708	1.945	10.132	1.402	3.077	0.884	-4.064
0.092	18.758	1.535	15.692	1.966	10.13	1.412	3.057	0.885	-4.082
0.112	18.749	1.536	15.693	1.968	10.106	1.404	3.042	0.896	-4.084
0.103	18.749	1.562	15.689	1.982	10.1	1.42	3.041	0.894	-4.11
0.127	18.756	1.54	15.673	2.008	10.092	1.417	3.015	0.875	-4.121
0.125	18.75	1.549	15.677	2.002	10.067	1.384	3.007	0.897	-4.122
0.11	18.75	1.564	15.67	1.987	10.063	1.397	3.002	0.898	-4.15
0.132	18.754	1.561	15.654	1.987	10.052	1.383	2.973	0.891	-4.153
0.111	18.751	1.577	15.662	1.922	10.027	1.379	2.967	0.908	-4.165
0.118	18.752	1.567	15.652	1.919	10.024	1.393	2.961	0.904	-4.188

Annex A

0.139	18.754	1.552	15.64	1.913	10.01	1.367	2.937	0.921	-4.194
0.119	18.744	1.57	15.642	1.908	9.99	1.363	2.933	0.931	-4.205
0.132	18.755	1.561	15.627	1.928	9.988	1.361	2.914	0.903	-4.224
0.139	18.753	1.553	15.622	1.951	9.968	1.339	2.896	0.918	-4.227
0.122	18.747	1.554	15.622	1.943	9.954	1.352	2.898	0.929	-4.246
0.141	18.754	1.541	15.608	1.965	9.952	1.364	2.878	0.912	-4.262
0.15	18.752	1.502	15.608	1.942	9.926	1.337	2.857	0.922	-4.267
0.148	18.749	1.513	15.61	1.918	9.918	1.34	2.858	0.92	-4.29
0.161	18.755	1.482	15.59	1.927	9.911	1.342	2.834	0.92	-4.301
0.174	18.749	1.454	15.59	1.915	9.884	1.338	2.825	0.94	-4.302
0.168	18.751	1.455	15.586	1.885	9.88	1.361	2.819	0.923	-4.327
0.196	18.757	1.431	15.57	1.896	9.869	1.355	2.795	0.918	-4.334
0.187	18.746	1.437	15.575	1.889	9.848	1.38	2.789	0.948	-4.341
0.194	18.752	1.433	15.561	1.925	9.846	1.406	2.779	0.931	-4.365
0.223	18.754	1.403	15.554	1.942	9.832	1.38	2.754	0.938	-4.368
0.219	18.747	1.423	15.556	1.943	9.81	1.396	2.755	0.941	-4.385
0.229	18.755	1.416	15.542	1.977	9.811	1.404	2.737	0.91	-4.405
0.243	18.753	1.396	15.536	1.963	9.789	1.4	2.721	0.92	-4.403
0.253	18.748	1.418	15.539	1.944	9.772	1.409	2.72	0.906	-4.425
0.268	18.753	1.419	15.52	1.935	9.771	1.407	2.7	0.887	-4.445
0.293	18.753	1.421	15.52	1.922	9.751	1.383	2.683	0.886	-4.446
0.288	18.747	1.453	15.522	1.907	9.742	1.388	2.683	0.889	-4.469
0.304	18.753	1.436	15.502	1.903	9.736	1.381	2.659	0.859	-4.484
0.336	18.749	1.458	15.504	1.888	9.709	1.359	2.648	0.857	-4.488
0.394	18.75	1.476	15.5	1.88	9.706	1.358	2.641	0.858	-4.509
0.487	18.755	1.47	15.485	1.888	9.694	1.332	2.618	0.856	-4.517
0.548	18.745	1.5	15.49	1.868	9.671	1.324	2.607	0.847	-4.526
0.599	18.749	1.517	15.482	1.884	9.672	1.349	2.6	0.805	-4.553
0.663	18.754	1.518	15.469	1.9	9.657	1.32	2.575	0.826	-4.559
0.722	18.745	1.533	15.473	1.885	9.635	1.317	2.573	0.838	-4.581
0.78	18.747	1.535	15.458	1.893	9.636	1.336	2.557	0.822	-4.601
0.87	18.749	1.518	15.448	1.908	9.612	1.318	2.533	0.819	-4.599
0.964	18.745	1.532	15.458	1.916	9.597	1.327	2.536	0.829	-4.621
1.087	18.744	1.516	15.435	1.932	9.598	1.339	2.516	0.812	-4.642
1.204	18.745	1.515	15.434	1.93	9.572	1.34	2.498	0.82	-4.644
1.316	18.739	1.532	15.434	1.923	9.562	1.38	2.499	0.853	-4.661
1.439	18.748	1.531	15.417	1.937	9.555	1.389	2.478	0.87	-4.682
1.537	18.739	1.547	15.421	1.951	9.536	1.382	2.463	0.891	-4.681
1.585	18.733	1.574	15.412	1.948	9.529	1.412	2.459	0.872	-4.705
1.667	18.741	1.552	15.399	1.953	9.519	1.404	2.433	0.875	-4.707
1.743	18.732	1.579	15.406	1.939	9.493	1.42	2.431	0.906	-4.713

Annex A

1.79	18.73	1.572	15.395	1.932	9.494	1.442	2.423	0.901	-4.739
1.866	18.734	1.556	15.377	1.96	9.479	1.437	2.394	0.913	-4.739
1.922	18.726	1.576	15.386	1.957	9.456	1.435	2.394	0.923	-4.751
1.98	18.725	1.589	15.373	1.985	9.458	1.435	2.381	0.902	-4.779
2.061	18.724	1.579	15.362	1.985	9.437	1.43	2.357	0.886	-4.78
2.087	18.709	1.58	15.367	1.967	9.419	1.432	2.357	0.873	-4.797
2.152	18.714	1.563	15.35	1.97	9.417	1.422	2.343	0.855	-4.818
2.192	18.706	1.534	15.346	1.958	9.395	1.39	2.323	0.864	-4.821
2.2	18.694	1.542	15.345	1.943	9.384	1.399	2.319	0.859	-4.84
2.221	18.698	1.523	15.328	1.957	9.383	1.402	2.298	0.85	-4.853
2.246	18.686	1.523	15.327	1.932	9.359	1.402	2.287	0.877	-4.858
2.238	18.682	1.552	15.327	1.929	9.353	1.43	2.284	0.873	-4.883
2.246	18.683	1.533	15.308	1.96	9.345	1.418	2.259	0.86	-4.887
2.205	18.669	1.516	15.3	1.955	9.318	1.418	2.254	0.884	-4.898
2.1	18.666	1.532	15.296	1.986	9.32	1.424	2.244	0.869	-4.924
2.055	18.673	1.513	15.278	2.01	9.305	1.39	2.218	0.868	-4.927
1.993	18.664	1.523	15.284	1.983	9.285	1.36	2.213	0.887	-4.934
1.96	18.665	1.527	15.272	1.96	9.282	1.346	2.202	0.879	-4.964
1.957	18.666	1.515	15.26	1.922	9.262	1.317	2.174	0.862	-4.961
1.915	18.657	1.525	15.266	1.88	9.244	1.301	2.173	0.857	-4.98
1.9	18.667	1.521	15.249	1.876	9.246	1.287	2.152	0.829	-5.001
1.893	18.662	1.509	15.243	1.874	9.22	1.263	2.138	0.831	-5.002
1.864	18.656	1.535	15.246	1.853	9.207	1.257	2.134	0.836	-5.023
1.877	18.666	1.538	15.232	1.87	9.203	1.257	2.115	0.826	-5.037
1.876	18.661	1.542	15.231	1.844	9.176	1.248	2.102	0.859	-5.037
1.915	18.654	1.558	15.231	1.838	9.173	1.266	2.101	0.859	-5.065
1.987	18.662	1.569	15.216	1.862	9.161	1.254	2.072	0.857	-5.07
2.049	18.657	1.575	15.218	1.864	9.135	1.244	2.063	0.887	-5.078
2.108	18.654	1.603	15.217	1.881	9.136	1.258	2.059	0.886	-5.103
2.174	18.655	1.611	15.2	1.902	9.126	1.254	2.033	0.896	-5.106
2.187	18.643	1.614	15.199	1.905	9.101	1.261	2.028	0.924	-5.114
2.218	18.647	1.641	15.193	1.944	9.101	1.275	2.016	0.902	-5.137
2.242	18.643	1.634	15.181	1.944	9.083	1.271	1.994	0.91	-5.138
2.241	18.626	1.645	15.182	1.919	9.066	1.295	1.993	0.9	-5.156
2.241	18.633	1.645	15.173	1.94	9.065	1.299	1.971	0.855	-5.177
2.246	18.62	1.634	15.16	1.939	9.04	1.283	1.954	0.848	-5.178
2.238	18.608	1.644	15.167	1.941	9.031	1.288	1.956	0.836	-5.205
2.244	18.61	1.652	15.151	1.956	9.029	1.294	1.939	0.832	-5.216
2.26	18.6	1.634	15.144	1.944	9.001	1.293	1.924	0.853	-5.217
2.257	18.594	1.637	15.148	1.929	8.993	1.323	1.921	0.858	-5.243
2.267	18.596	1.644	15.135	1.942	8.989	1.341	1.899	0.861	-5.253

Annex A

2.26	18.578	1.63	15.128	1.942	8.967	1.337	1.887	0.877	-5.26
2.266	18.574	1.643	15.13	1.956	8.964	1.354	1.879	0.857	-5.284
2.294	18.576	1.633	15.113	1.961	8.953	1.329	1.856	0.844	-5.289
2.278	18.557	1.624	15.112	1.939	8.926	1.3	1.854	0.86	-5.3
2.271	18.557	1.64	15.107	1.93	8.927	1.297	1.837	0.825	-5.323
2.287	18.557	1.617	15.091	1.924	8.906	1.24	1.814	0.832	-5.325
2.28	18.541	1.623	15.095	1.887	8.887	1.225	1.813	0.841	-5.339
2.284	18.542	1.623	15.087	1.899	8.89	1.221	1.793	0.829	-5.361
2.295	18.534	1.614	15.073	1.905	8.869	1.206	1.775	0.85	-5.362
2.28	18.519	1.615	15.078	1.908	8.853	1.229	1.776	0.858	-5.383
2.29	18.525	1.629	15.065	1.941	8.85	1.23	1.753	0.833	-5.398
2.27	18.51	1.632	15.057	1.937	8.824	1.221	1.741	0.822	-5.397
2.262	18.504	1.644	15.058	1.911	8.817	1.244	1.737	0.829	-5.425
2.276	18.506	1.66	15.05	1.935	8.81	1.224	1.711	0.839	-5.434
2.269	18.489	1.661	15.039	1.944	8.786	1.206	1.704	0.869	-5.438
2.261	18.488	1.688	15.044	1.963	8.781	1.223	1.696	0.867	-5.461
2.27	18.49	1.674	15.028	1.986	8.774	1.218	1.675	0.893	-5.466
2.252	18.468	1.671	15.025	1.954	8.749	1.24	1.671	0.914	-5.475
2.242	18.468	1.68	15.023	1.944	8.749	1.252	1.657	0.897	-5.497
2.244	18.468	1.663	15.005	1.931	8.727	1.234	1.634	0.904	-5.497
2.239	18.45	1.66	15.009	1.863	8.707	1.256	1.634	0.92	-5.515
2.226	18.452	1.669	15.001	1.876	8.711	1.246	1.616	0.894	-5.537
2.225	18.445	1.663	14.988	1.878	8.687	1.216	1.594	0.908	-5.536
2.194	18.431	1.665	14.991	1.854	8.671	1.219	1.598	0.913	-5.558
2.198	18.437	1.662	14.982	1.866	8.671	1.221	1.573	0.904	-5.573
2.188	18.421	1.642	14.968	1.862	8.648	1.202	1.558	0.923	-5.57
2.135	18.408	1.644	14.971	1.85	8.634	1.21	1.556	0.924	-5.596
2.13	18.415	1.658	14.962	1.886	8.63	1.216	1.535	0.904	-5.609
2.133	18.4	1.647	14.954	1.875	8.606	1.227	1.527	0.9	-5.611
2.092	18.388	1.666	14.955	1.872	8.604	1.253	1.523	0.879	-5.641
2.092	18.394	1.637	14.935	1.898	8.592	1.237	1.495	0.876	-5.645
2.092	18.379	1.614	14.935	1.853	8.568	1.242	1.495	0.888	-5.656
2.088	18.372	1.608	14.934	1.852	8.568	1.26	1.48	0.855	-5.682
2.116	18.375	1.569	14.916	1.866	8.551	1.232	1.456	0.851	-5.681
2.106	18.355	1.557	14.915	1.847	8.527	1.243	1.456	0.869	-5.699
2.123	18.36	1.55	14.914	1.867	8.529	1.263	1.443	0.849	-5.718
2.144	18.357	1.535	14.897	1.873	8.511	1.247	1.421	0.838	-5.72
2.131	18.339	1.53	14.897	1.861	8.496	1.275	1.419	0.831	-5.743
2.146	18.346	1.533	14.891	1.883	8.494	1.272	1.4	0.827	-5.762
2.15	18.335	1.529	14.878	1.862	8.471	1.272	1.383	0.855	-5.758
2.127	18.321	1.538	14.882	1.85	8.459	1.303	1.381	0.864	-5.784

Annex A

2.134	18.327	1.543	14.871	1.857	8.457	1.288	1.356	0.875	-5.793
2.137	18.316	1.539	14.86	1.855	8.43	1.277	1.348	0.913	-5.796
2.11	18.305	1.529	14.864	1.873	8.427	1.274	1.341	0.91	-5.821
2.126	18.312	1.529	14.849	1.892	8.416	1.238	1.312	0.914	-5.825
2.116	18.293	1.51	14.844	1.871	8.394	1.214	1.309	0.93	-5.834
2.108	18.288	1.505	14.841	1.883	8.39	1.227	1.299	0.911	-5.86
2.134	18.291	1.494	14.83	1.909	8.375	1.214	1.273	0.923	-5.86
2.101	18.27	1.482	14.828	1.873	8.353	1.225	1.272	0.928	-5.869
2.083	18.27	1.509	14.825	1.862	8.355	1.233	1.258	0.917	-5.895
2.094	18.268	1.495	14.811	1.854	8.336	1.222	1.236	0.906	-5.893
2.061	18.248	1.506	14.809	1.842	8.313	1.241	1.235	0.901	-5.911
2.057	18.253	1.521	14.806	1.871	8.315	1.241	1.216	0.888	-5.931
2.079	18.246	1.509	14.792	1.866	8.291	1.216	1.202	0.909	-5.93
2.056	18.227	1.523	14.795	1.853	8.283	1.255	1.198	0.906	-5.956
2.067	18.235	1.535	14.786	1.872	8.279	1.253	1.173	0.884	-5.968
2.074	18.224	1.528	14.775	1.859	8.249	1.254	1.165	0.874	-5.971
2.054	18.212	1.537	14.778	1.844	8.244	1.269	1.165	0.855	-6.003
2.078	18.218	1.541	14.766	1.862	8.239	1.27	1.136	0.842	-6.002
2.081	18.199	1.542	14.754	1.826	8.211	1.264	1.128	0.854	-6.012
2.081	18.197	1.532	14.755	1.826	8.206	1.279	1.123	0.842	-6.04
2.102	18.197	1.548	14.742	1.816	8.195	1.257	1.096	0.85	-6.039
2.097	18.179	1.559	14.736	1.774	8.176	1.264	1.094	0.858	-6.054
2.083	18.177	1.575	14.738	1.765	8.175	1.275	1.078	0.828	-6.078
2.107	18.178	1.583	14.726	1.77	8.157	1.252	1.058	0.812	-6.077
2.089	18.156	1.6	14.724	1.767	8.14	1.283	1.059	0.807	-6.101
2.087	18.156	1.616	14.719	1.784	8.141	1.3	1.036	0.795	-6.113
2.094	18.154	1.617	14.705	1.787	8.118	1.271	1.02	0.824	-6.115
2.072	18.138	1.622	14.709	1.769	8.103	1.281	1.021	0.832	-6.14
2.077	18.141	1.653	14.699	1.782	8.101	1.289	0.993	0.842	-6.151
2.095	18.132	1.648	14.687	1.787	8.079	1.295	0.982	0.872	-6.152
2.075	18.119	1.656	14.691	1.765	8.062	1.313	0.981	0.867	-6.178
2.092	18.126	1.667	14.682	1.787	8.061	1.322	0.956	0.854	-6.186
2.102	18.108	1.672	14.672	1.772	8.037	1.322	0.945	0.88	-6.189
2.074	18.1	1.678	14.672	1.775	8.029	1.338	0.943	0.858	-6.219
2.08	18.104	1.664	14.659	1.769	8.019	1.309	0.916	0.853	-6.218
2.073	18.087	1.663	14.653	1.743	7.992	1.29	0.913	0.855	-6.235
2.058	18.079	1.653	14.654	1.741	7.994	1.283	0.897	0.826	-6.257
2.071	18.082	1.654	14.64	1.753	7.974	1.231	0.874	0.836	-6.252
2.056	18.065	1.646	14.636	1.717	7.953	1.227	0.876	0.848	-6.273
2.064	18.063	1.659	14.637	1.711	7.956	1.235	0.858	0.855	-6.287
2.076	18.061	1.64	14.621	1.691	7.934	1.217	0.837	0.884	-6.284

Annex A

2.052	18.044	1.621	14.618	1.658	7.916	1.225	0.836	0.891	-6.311
2.062	18.048	1.63	14.613	1.661	7.915	1.224	0.812	0.88	-6.324
2.068	18.04	1.633	14.599	1.672	7.892	1.217	0.801	0.901	-6.326
2.047	18.026	1.629	14.601	1.683	7.881	1.262	0.8	0.902	-6.357
2.058	18.031	1.644	14.595	1.724	7.879	1.244	0.777	0.875	-6.359
2.069	18.021	1.628	14.582	1.751	7.854	1.24	0.769	0.879	-6.364
2.044	18.007	1.644	14.582	1.792	7.85	1.251	0.764	0.862	-6.393
2.063	18.014	1.636	14.572	1.836	7.841	1.227	0.737	0.87	-6.395
2.062	17.996	1.625	14.564	1.83	7.816	1.253	0.735	0.877	-6.413
2.036	17.99	1.652	14.564	1.849	7.813	1.282	0.721	0.844	-6.434
2.03	17.989	1.645	14.551	1.869	7.804	1.271	0.698	0.843	-6.432
1.994	17.976	1.633	14.548	1.845	7.785	1.3	0.699	0.846	-6.453
1.973	17.971	1.648	14.547	1.864	7.786	1.318	0.684	0.812	-6.474
1.987	17.97	1.641	14.53	1.881	7.765	1.319	0.663	0.82	-6.468
1.96	17.954	1.65	14.53	1.888	7.747	1.334	0.661	0.829	-6.495
1.956	17.956	1.663	14.529	1.92	7.747	1.325	0.642	0.802	-6.509
1.981	17.949	1.674	14.512	1.941	7.728	1.303	0.622	0.805	-6.51
1.942	17.934	1.684	14.514	1.939	7.713	1.3	0.623	0.796	-6.536
1.951	17.938	1.703	14.507	1.947	7.709	1.274	0.597	0.79	-6.542
1.954	17.93	1.705	14.499	1.909	7.684	1.263	0.591	0.825	-6.551
1.93	17.917	1.727	14.497	1.898	7.679	1.286	0.584	0.813	-6.575
1.936	17.918	1.727	14.486	1.887	7.668	1.264	0.555	0.823	-6.577
1.93	17.909	1.714	14.478	1.861	7.644	1.251	0.551	0.844	-6.589
1.914	17.9	1.702	14.481	1.871	7.64	1.262	0.54	0.824	-6.617
1.935	17.898	1.705	14.465	1.893	7.632	1.243	0.515	0.845	-6.612
1.93	17.886	1.683	14.456	1.884	7.606	1.24	0.517	0.855	-6.631
1.914	17.881	1.679	14.458	1.894	7.604	1.259	0.5	0.823	-6.649
1.911	17.881	1.663	14.445	1.88	7.588	1.245	0.477	0.83	-6.646
1.894	17.863	1.656	14.444	1.841	7.568	1.267	0.476	0.835	-6.671
1.878	17.861	1.663	14.443	1.86	7.566	1.275	0.456	0.815	-6.686
1.873	17.858	1.637	14.427	1.864	7.547	1.263	0.439	0.819	-6.685
1.857	17.843	1.637	14.431	1.856	7.533	1.295	0.441	0.805	-6.715
1.851	17.848	1.65	14.421	1.889	7.53	1.293	0.417	0.81	-6.721
1.847	17.837	1.629	14.408	1.866	7.505	1.292	0.408	0.817	-6.728
1.819	17.824	1.626	14.411	1.84	7.497	1.312	0.401	0.808	-6.752
1.821	17.826	1.642	14.4	1.853	7.486	1.276	0.375	0.801	-6.756
1.816	17.816	1.619	14.39	1.831	7.464	1.27	0.372	0.798	-6.77
1.799	17.802	1.627	14.395	1.83	7.461	1.282	0.366	0.762	-6.795
1.808	17.806	1.622	14.38	1.841	7.451	1.268	0.341	0.769	-6.793
1.787	17.792	1.622	14.374	1.812	7.425	1.275	0.336	0.787	-6.81
1.777	17.783	1.617	14.373	1.824	7.423	1.291	0.324	0.763	-6.833

Annex A

1.775	17.788	1.612	14.36	1.816	7.409	1.292	0.301	0.791	-6.832
1.755	17.77	1.604	14.356	1.793	7.391	1.308	0.303	0.809	-6.851
1.73	17.771	1.623	14.354	1.814	7.388	1.302	0.282	0.812	-6.867
1.735	17.768	1.624	14.34	1.836	7.371	1.282	0.268	0.831	-6.87
1.712	17.75	1.642	14.339	1.839	7.358	1.292	0.264	0.824	-6.895
1.694	17.748	1.687	14.335	1.872	7.359	1.286	0.24	0.803	-6.901
1.667	17.745	1.673	14.321	1.879	7.331	1.255	0.229	0.821	-6.907
1.64	17.732	1.695	14.328	1.88	7.322	1.278	0.227	0.79	-6.936
1.639	17.73	1.713	14.316	1.903	7.32	1.29	0.199	0.784	-6.938
1.632	17.721	1.692	14.301	1.901	7.293	1.291	0.192	0.799	-6.948
1.619	17.708	1.692	14.306	1.909	7.288	1.324	0.187	0.785	-6.977
1.604	17.712	1.683	14.295	1.942	7.279	1.314	0.16	0.805	-6.974
1.608	17.697	1.667	14.287	1.928	7.257	1.315	0.158	0.841	-6.989
1.582	17.688	1.683	14.284	1.912	7.254	1.315	0.144	0.838	-7.007
1.59	17.691	1.668	14.274	1.892	7.233	1.285	0.118	0.858	-7.011
1.577	17.678	1.672	14.272	1.869	7.212	1.299	0.124	0.878	-7.031
1.558	17.671	1.688	14.267	1.874	7.216	1.292	0.098	0.867	-7.046
1.579	17.667	1.67	14.25	1.88	7.194	1.286	0.083	0.887	-7.046
1.561	17.655	1.663	14.252	1.869	7.177	1.311	0.084	0.886	-7.071
1.561	17.653	1.679	14.249	1.895	7.179	1.319	0.063	0.869	-7.078
1.572	17.651	1.612	14.239	1.91	7.156	1.313	0.047	0.886	-7.082
1.56	17.636	1.567	14.238	1.901	7.14	1.322	0.045	0.877	-7.108
1.564	17.635	1.741	14.229	1.911	7.135	1.299	0.019	0.888	-7.114
1.559	17.627	1.734	14.211	1.917	7.112	1.286	0.012	0.889	-7.12
1.538	17.614	1.717	14.21	1.933	7.111	1.302	0.004	0.877	-7.149
1.532	17.616	1.701	14.185	1.961	7.1	1.274	-0.018	0.866	-7.151
1.516	17.608	1.685	14.177	1.942	7.074	1.261	-0.02	0.875	-7.164
1.496	17.596	1.702	14.171	1.952	7.071	1.264	-0.035	0.851	-7.189
1.488	17.595	1.664	14.142	1.95	7.058	1.231	-0.059	0.86	-7.186
1.485	17.586	1.629	14.139	1.93	7.036	1.25	-0.061	0.845	-7.206
1.473	17.577	1.627	14.13	1.946	7.036	1.267	-0.078	0.825	-7.224
1.484	17.577	1.585	14.104	1.952	7.021	1.247	-0.096	0.847	-7.225
1.479	17.565	1.608	14.102	1.933	7.005	1.254	-0.097	0.826	-7.252
1.478	17.564	1.629	14.088	1.95	7.005	1.277	-0.114	0.8	-7.266
1.494	17.562	1.656	14.066	1.946	6.98	1.283	-0.131	0.823	-7.262
1.492	17.548	1.692	14.064	1.936	6.968	1.306	-0.134	0.82	-7.29
1.492	17.548	1.729	14.049	1.927	6.964	1.299	-0.159	0.825	-7.297
1.482	17.542	1.745	14.037	1.899	6.939	1.32	-0.168	0.841	-7.303
1.471	17.526	1.777	14.035	1.883	6.929	1.329	-0.177	0.821	-7.329
1.475	17.528	1.777	14.015	1.888	6.92	1.312	-0.198	0.82	-7.332
1.472	17.523	1.775	14.003	1.862	6.897	1.32	-0.199	0.839	-7.344

Annex A

1.465	17.506	1.812	13.999	1.847	6.895	1.34	-0.214	0.834	-7.367
1.46	17.508	1.817	13.971	1.854	6.88	1.333	-0.239	0.86	-7.364
1.465	17.501	1.792	13.969	1.838	6.856	1.334	-0.238	0.868	-7.385
1.445	17.493	1.792	13.961	1.857	6.855	1.339	-0.255	0.844	-7.405
1.458	17.491	1.752	13.936	1.888	6.839	1.328	-0.276	0.854	-7.403
1.47	17.479	1.743	13.929	1.893	6.823	1.339	-0.274	0.847	-7.426
1.466	17.476	1.737	13.92	1.912	6.818	1.337	-0.296	0.81	-7.44
1.478	17.473	1.724	13.897	1.89	6.796	1.324	-0.31	0.817	-7.44
1.467	17.46	1.743	13.894	1.877	6.783	1.304	-0.315	0.808	-7.465
1.435	17.455	1.76	13.875	1.883	6.779	1.272	-0.342	0.784	-7.475
1.449	17.456	1.768	13.862	1.845	6.753	1.249	-0.348	0.798	-7.483
1.441	17.439	1.777	13.862	1.835	6.746	1.252	-0.352	0.783	-7.51
1.437	17.437	1.774	13.838	1.811	6.74	1.23	-0.381	0.8	-7.512
1.456	17.432	1.767	13.823	1.759	6.712	1.226	-0.385	0.827	-7.523
1.437	17.419	1.783	13.823	1.767	6.707	1.261	-0.391	0.818	-7.548
1.436	17.423	1.754	13.801	1.798	6.696	1.258	-0.414	0.833	-7.545
1.437	17.41	1.747	13.786	1.765	6.674	1.277	-0.417	0.86	-7.561
1.425	17.403	1.795	13.784	1.761	6.67	1.277	-0.431	0.852	-7.586
1.441	17.406	1.8	13.76	1.758	6.656	1.249	-0.454	0.858	-7.584
1.438	17.394	1.828	13.758	1.738	6.634	1.246	-0.456	0.872	-7.607
1.419	17.385	1.832	13.747	1.762	6.634	1.253	-0.475	0.854	-7.621
1.437	17.383	1.831	13.722	1.762	6.616	1.244	-0.493	0.872	-7.622
1.42	17.371	1.863	13.723	1.756	6.602	1.25	-0.495	0.875	-7.645
1.425	17.366	1.869	13.705	1.769	6.599	1.242	-0.516	0.873	-7.656
1.442	17.365	1.868	13.687	1.758	6.578	1.228	-0.533	0.89	-7.664
1.435	17.35	1.874	13.685	1.739	6.568	1.256	-0.531	0.868	-7.69
1.435	17.35	1.882	13.669	1.75	6.562	1.239	-0.559	0.871	-7.688
1.446	17.344	1.877	13.653	1.746	6.533	1.252	-0.564	0.88	-7.702
1.436	17.332	1.912	13.654	1.738	6.531	1.288	-0.569	0.848	-7.728
1.448	17.333	1.928	13.63	1.76	6.52	1.288	-0.597	0.853	-7.728
1.473	17.324	1.93	13.62	1.752	6.496	1.311	-0.597	0.861	-7.74
1.477	17.315	1.954	13.617	1.766	6.493	1.301	-0.612	0.852	-7.765
1.49	17.316	1.937	13.597	1.813	6.484	1.287	-0.634	0.85	-7.765
1.505	17.306	1.946	13.587	1.821	6.462	1.296	-0.634	0.847	-7.784
1.5	17.296	1.941	13.578	1.835	6.459	1.308	-0.654	0.846	-7.8
1.514	17.298	1.923	13.557	1.841	6.439	1.308	-0.669	0.867	-7.801
1.519	17.285	1.925	13.556	1.801	6.424	1.32	-0.67	0.86	-7.824
1.539	17.278	1.911	13.538	1.809	6.424	1.321	-0.696	0.848	-7.833
1.545	17.276	1.88	13.515	1.78	6.398	1.295	-0.709	0.844	-7.836
1.537	17.262	1.859	13.514	1.753	6.384	1.288	-0.71	0.794	-7.866
1.533	17.264	1.855	13.499	1.753	6.38	1.263	-0.736	0.804	-7.869

Annex A

1.552	17.257	1.837	13.479	1.738	6.356	1.253	-0.746	0.84	-7.874
1.532	17.244	1.831	13.476	1.732	6.348	1.258	-0.753	0.837	-7.903
1.542	17.246	1.811	13.456	1.741	6.338	1.26	-0.777	0.853	-7.905
1.543	17.239	1.8	13.446	1.725	6.315	1.259	-0.781	0.875	-7.919
1.511	17.224	1.83	13.435	1.728	6.312	1.277	-0.79	0.84	-7.943
1.525	17.225	1.808	13.411	1.758	6.299	1.262	-0.816	0.847	-7.942
1.53	17.217	1.815	13.408	1.745	6.278	1.26	-0.813	0.861	-7.958
1.529	17.209	1.84	13.4	1.736	6.279	1.26	-0.832	0.854	-7.978
1.553	17.205	1.82	13.375	1.74	6.26	1.24	-0.854	0.86	-7.977
1.548	17.194	1.817	13.37	1.72	6.24	1.239	-0.855	0.851	-8
1.564	17.193	1.84	13.36	1.726	6.239	1.227	-0.877	0.827	-8.012
1.588	17.191	1.848	13.338	1.728	6.223	1.213	-0.891	0.846	-8.013
1.574	17.177	1.882	13.335	1.709	6.209	1.218	-0.889	0.85	-8.042
1.552	17.177	1.913	13.321	1.736	6.207	1.223	-0.918	0.842	-8.047
1.535	17.173	1.921	13.307	1.73	6.184	1.222	-0.926	0.853	-8.059
1.521	17.161	1.955	13.303	1.721	6.171	1.252	-0.932	0.841	-8.082
1.507	17.156	1.961	13.285	1.734	6.165	1.246	-0.958	0.836	-8.084
1.515	17.154	1.95	13.269	1.727	6.143	1.262	-0.963	0.851	-8.095
1.53	17.141	1.967	13.268	1.745	6.138	1.283	-0.975	0.83	-8.119
1.519	17.142	1.963	13.248	1.767	6.127	1.267	-0.995	0.838	-8.122
1.52	17.129	1.958	13.236	1.743	6.103	1.272	-0.995	0.83	-8.142
1.504	17.123	1.984	13.23	1.751	6.103	1.273	-1.013	0.802	-8.158
1.504	17.127	1.956	13.205	1.766	6.084	1.254	-1.035	0.805	-8.157
1.521	17.114	1.954	13.198	1.753	6.064	1.254	-1.038	0.805	-8.185
1.512	17.108	1.925	13.19	1.749	6.064	1.257	-1.054	0.796	-8.195
1.515	17.106	1.91	13.167	1.738	6.045	1.226	-1.073	0.825	-8.198
1.509	17.098	1.913	13.166	1.733	6.031	1.232	-1.077	0.794	-8.223
1.494	17.092	1.927	13.15	1.749	6.025	1.231	-1.094	0.771	-8.232
1.504	17.091	1.938	13.13	1.748	6.004	1.233	-1.106	0.785	-8.237
1.484	17.074	1.959	13.128	1.754	5.995	1.259	-1.111	0.765	-8.26
1.487	17.074	1.965	13.106	1.782	5.985	1.254	-1.139	0.773	-8.263
1.492	17.071	1.943	13.095	1.765	5.961	1.252	-1.142	0.799	-8.279
1.487	17.056	1.957	13.092	1.774	5.961	1.267	-1.151	0.804	-8.301
1.487	17.055	1.954	13.068	1.774	5.948	1.239	-1.179	0.807	-8.301
1.486	17.045	1.95	13.058	1.765	5.924	1.224	-1.178	0.821	-8.318
1.47	17.04	1.959	13.056	1.752	5.917	1.22	-1.188	0.811	-8.338
1.443	17.038	1.95	13.032	1.747	5.907	1.212	-1.211	0.832	-8.337
1.439	17.024	1.925	13.021	1.731	5.885	1.217	-1.213	0.826	-8.356
1.429	17.015	1.92	13.013	1.729	5.881	1.238	-1.23	0.819	-8.376
1.444	17.019	1.903	12.995	1.726	5.867	1.247	-1.246	0.831	-8.377
1.443	17.003	1.914	12.986	1.718	5.853	1.27	-1.252	0.819	-8.402

Annex A

1.441	16.996	1.95	12.973	1.718	5.85	1.27	-1.269	0.809	-8.408
1.446	16.996	1.953	12.955	1.715	5.826	1.244	-1.281	0.824	-8.417
1.448	16.987	1.954	12.955	1.717	5.816	1.263	-1.287	0.798	-8.438
1.451	16.984	1.971	12.935	1.743	5.812	1.278	-1.314	0.797	-8.443
1.474	16.977	1.943	12.916	1.728	5.788	1.267	-1.318	0.798	-8.458
1.469	16.966	1.941	12.915	1.737	5.778	1.257	-1.33	0.774	-8.483
1.468	16.967	1.899	12.894	1.74	5.773	1.214	-1.355	0.761	-8.482
1.489	16.958	1.869	12.879	1.735	5.748	1.203	-1.357	0.782	-8.501
1.482	16.944	1.838	12.878	1.754	5.746	1.203	-1.371	0.772	-8.519
1.495	16.947	1.804	12.856	1.75	5.732	1.182	-1.396	0.779	-8.517
1.495	16.938	1.769	12.845	1.724	5.709	1.168	-1.396	0.77	-8.538
1.491	16.929	1.765	12.835	1.728	5.707	1.182	-1.413	0.766	-8.555
1.501	16.928	1.747	12.813	1.731	5.687	1.197	-1.431	0.778	-8.559
1.495	16.914	1.76	12.808	1.705	5.674	1.22	-1.429	0.759	-8.577
1.472	16.91	1.797	12.798	1.727	5.669	1.245	-1.453	0.767	-8.589
1.46	16.907	1.812	12.778	1.731	5.648	1.257	-1.465	0.782	-8.594
1.449	16.894	1.846	12.777	1.72	5.635	1.288	-1.467	0.78	-8.618
1.443	16.892	1.864	12.76	1.73	5.631	1.287	-1.493	0.808	-8.621
1.46	16.891	1.852	12.74	1.71	5.606	1.264	-1.502	0.819	-8.632
1.453	16.875	1.862	12.742	1.691	5.597	1.248	-1.508	0.799	-8.661
1.444	16.872	1.856	12.721	1.676	5.59	1.233	-1.534	0.803	-8.659
1.459	16.867	1.852	12.705	1.652	5.569	1.223	-1.538	0.782	-8.674
1.458	16.854	1.857	12.701	1.639	5.559	1.229	-1.552	0.768	-8.694
1.447	16.855	1.83	12.68	1.625	5.545	1.205	-1.57	0.771	-8.696
1.465	16.846	1.822	12.67	1.568	5.526	1.192	-1.572	0.788	-8.715
1.452	16.835	1.835	12.66	1.569	5.521	1.184	-1.587	0.787	-8.732
1.447	16.836	1.808	12.639	1.592	5.505	1.151	-1.61	0.804	-8.735
1.45	16.827	1.787	12.633	1.605	5.487	1.165	-1.611	0.804	-8.757
1.444	16.821	1.781	12.624	1.658	5.489	1.146	-1.629	0.795	-8.768
1.465	16.815	1.749	12.598	1.681	5.469	1.116	-1.649	0.809	-8.774
1.453	16.803	1.737	12.591	1.673	5.453	1.136	-1.651	0.798	-8.796
1.459	16.803	1.735	12.58	1.685	5.451	1.147	-1.672	0.806	-8.803
1.474	16.801	1.723	12.558	1.676	5.43	1.111	-1.684	0.86	-8.814
1.459	16.784	1.723	12.554	1.668	5.422	1.102	-1.692	0.859	-8.84
1.473	16.786	1.754	12.538	1.689	5.413	1.075	-1.716	0.89	-8.84
1.469	16.783	1.749	12.527	1.69	5.39	1.078	-1.72	0.906	-8.854
1.469	16.771	1.771	12.521	1.711	5.387	1.09	-1.734	0.911	-8.874
1.486	16.768	1.762	12.497	1.721	5.374	1.084	-1.755	0.919	-8.878
1.508	16.763	1.746	12.488	1.7	5.35	1.106	-1.758	0.92	-8.892
1.501	16.752	1.77	12.492	1.675	5.347	1.143	-1.771	0.902	-8.913
1.511	16.75	1.77	12.466	1.685	5.333	1.153	-1.792	0.923	-8.913

Annex A

1.493	16.742	1.775	12.46	1.656	5.309	1.183	-1.791	0.897	-8.94
1.492	16.734	1.812	12.454	1.665	5.309	1.2	-1.812	0.857	-8.948
1.495	16.732	1.795	12.431	1.678	5.291	1.2	-1.826	0.859	-8.956
1.47	16.721	1.8	12.422	1.689	5.275	1.208	-1.83	0.824	-8.982
1.451	16.713	1.806	12.41	1.725	5.274	1.215	-1.851	0.783	-8.988
1.461	16.713	1.775	12.391	1.735	5.254	1.228	-1.865	0.77	-8.995
1.449	16.702	1.785	12.389	1.746	5.244	1.267	-1.868	0.743	-9.019
1.451	16.697	1.793	12.371	1.76	5.235	1.245	-1.891	0.753	-9.023
1.47	16.693	1.77	12.356	1.739	5.214	1.243	-1.9	0.775	-9.036
1.48	16.68	1.799	12.352	1.737	5.204	1.237	-1.911	0.778	-9.058
1.491	16.681	1.797	12.329	1.741	5.192	1.212	-1.93	0.798	-9.056
1.517	16.672	1.787	12.318	1.7	5.166	1.201	-1.937	0.822	-9.079
1.523	16.66	1.786	12.314	1.688	5.166	1.201	-1.95	0.804	-9.094
1.54	16.665	1.765	12.292	1.698	5.156	1.18	-1.973	0.821	-9.092
1.553	16.651	1.758	12.281	1.685	5.131	1.172	-1.971	0.823	-9.117
1.543	16.646	1.774	12.276	1.708	5.128	1.165	-1.99	0.814	-9.131
1.554	16.644	1.792	12.252	1.714	5.116	1.143	-2.01	0.85	-9.13
1.553	16.632	1.78	12.246	1.694	5.095	1.149	-2.011	0.844	-9.156
1.54	16.626	1.771	12.234	1.687	5.09	1.139	-2.032	0.848	-9.164
1.543	16.627	1.743	12.213	1.669	5.069	1.135	-2.046	0.87	-9.169
1.512	16.614	1.755	12.212	1.626	5.062	1.16	-2.052	0.863	-9.196
1.525	16.606	1.788	12.192	1.634	5.056	1.15	-2.076	0.852	-9.2
1.518	16.605	1.78	12.176	1.601	5.029	1.143	-2.081	0.86	-9.213
1.506	16.59	1.807	12.177	1.581	5.025	1.175	-2.089	0.811	-9.234
1.523	16.59	1.812	12.153	1.583	5.019	1.153	-2.118	0.823	-9.234
1.545	16.585	1.825	12.141	1.573	4.991	1.142	-2.119	0.823	-9.255
1.537	16.572	1.838	12.137	1.587	4.987	1.151	-2.135	0.797	-9.274
1.535	16.574	1.849	12.119	1.582	4.978	1.127	-2.153	0.798	-9.275
1.546	16.563	1.857	12.109	1.571	4.958	1.046	-2.161	0.8	-9.297
1.529	16.552	1.873	12.099	1.586	4.95	1.074	-2.173	0.786	-9.309
1.528	16.555	1.883	12.082	1.599	4.933	1.081	-2.193	0.775	-9.314
1.531	16.545	1.919	12.078	1.571	4.915	1.098	-2.196	0.766	-9.338
1.521	16.536	1.942	12.065	1.587	4.914	1.116	-2.217	0.765	-9.345
1.529	16.536	1.93	12.042	1.616	4.894	1.116	-2.232	0.782	-9.354
1.508	16.526	1.936	12.045	1.61	4.879	1.151	-2.233	0.774	-9.378
1.503	16.521	1.932	12.028	1.631	4.877	1.151	-2.256	0.779	-9.379
1.501	16.517	1.909	12.006	1.614	4.853	1.138	-2.266	0.797	-9.389
1.487	16.502	1.931	12.006	1.597	4.842	1.129	-2.272	0.758	-9.41
1.492	16.505	1.933	11.985	1.595	4.835	1.109	-2.297	0.765	-9.408
1.5	16.497	1.936	11.972	1.575	4.812	1.103	-2.302	0.787	-9.426
1.487	16.484	1.955	11.969	1.579	4.803	1.097	-2.314	0.783	-9.45

Annex A

		1.943	11.946	1.583	4.792	1.096	-2.337	0.807	-9.45
		1.951	11.937	1.597	4.775	1.117	-2.337	0.824	-9.466
		1.976	11.931	1.617	4.771	1.129	-2.354	0.81	-9.481
		1.983	11.906	1.638	4.753	1.131	-2.37	0.833	-9.483
		1.981	11.902	1.632	4.736	1.147	-2.372	0.81	-9.505
		1.973	11.888	1.672	4.737	1.143	-2.394	0.813	-9.518
		1.919	11.867	1.674	4.714	1.115	-2.409		
		1.9	11.866	1.655	4.7	1.126	-2.407		

Figure 14. Tensile Trial 8 Results.