

**CO- LIVING:**

*A strategy for the future city housing*

**PRACTICES**

# CO- LIVING:

A strategy for the future city housing

Book of practices



Politecnico di Milano  
Scuola AUIC

Master Thesis in Architettura  
A.Y. 2018/2019

Relatore: prof. Gennaro Postiglione  
Correlatore: prof. Stefania Sabatinelli

Studente: Laura Vanazzi (matricola: 873900)

## WHAT ARE THE PRACTICES ABOUT?

The literature proposed show a **re-emerging of shared living** as consequence of the sociological and economical changes of the new century and at the same time, a necessity of new housing policies for the actual living practices. In order to understand deeply the phenomenon and have a wide view of the reality of shared living, I decided to introduce a chapter composed by real people living in un-conditional situation. **Un-conditional situation** means people who lives in condition different from the stereotyped of the traditional family: a heterosexual couple composed by a man and a woman with their biological children. The case reported are taken from a research made in Politecnico di Milano from the international class of Thematic Design Studio in 2018; the bachelor students were guided by the professors Massimo Bricocoli, Rodrigo Pemjean Munoz and Gennaro Postiglione; with the assistance of the tutors Martina Bovo, Tommaso Raimondi and Tommaso Vacchi. The studio was called **“Re.Co.De 2018!”**, the final purpose was to convert a traditional Milanese apartment building in two or more shared living apartment; the users were choose by the un-conventional families mapped during the studio, with the aim of studying the relationship between these people and their household.

The users were one for each student, they had to be people coming from their affective network, so that they will be interviewed and it will be possible visit and make a survey of the house. This work had the aim of track the daily-life of the household choosen, underlining the relationship between the life of the residents and their activities, the problems, the positive aspects and the behaviour due to the organization of the space, but at the same time, their life not depending on the house where they are living. It was then necessary translate this information into diagrams that shows the use of the space at different times during the day, the levels of privacy and overcrowding and specific characteristics that explain the un-comfortable living for each apartment (if present). The students were also in charge of taking different pictures and producing a plan and a section which represent the real space in which these people were living: it means that all the furniture and relevant objects inside the house were inserted in the drawings in order to understand how really the residents are interacting their life with the space.

The mapping produced a real panoramic of what is the living situation today and how different the housing realities are, confirmed what was emerging in the literature: there are people from **different generations and not blood-related who lives together**. Important is also to notice that since the class was made by international students, the mapping of the case studies came from **all over the world**, showing that the co-habitation as intergenerational and blood-related is a worldwide phenomenon. The cases show at the same time how people must adapt their social, work and economical situation to their living condition or in some case, adapt the social or working condition to their

Postiglione, G., Sabatinelli, S. and Bricocoli, M. (2018). RE.CO.DE: REDESIGNING CONTEMPORARY DWELLING- INSIDE THE CITY. AUIC School and Department of Architecture and Urban Studies - Politecnico di Milano.

household. There are elderly living alone in space too big or too small and without the possibility of being adaptable, elderly hosting a caregiver that can help them, people renting vacant rooms to students, workers or tourists, families who owned two household since the parents are living in different cities; but also people whose workplace coincide with their household or different families who lives in the same place.

There are about **100 different case studies** of different living, for this reason they were classified in different groups due to the similarity of their conditions. The housing typologies defined are the following:

- **Single adult:** composed by people living alone
- **Single adult Plus:** composed by two single adult person who lives together as a temporary or long-term solution and often blood-related or connected by familiar relationship.
- **Adult(s) and Adult(s):** made by two single adult person who decided to live together as a permanent decision, not blood-related and with an independent life.
- **Couple + Adult(s):** composed by a couple without children who decided to host another person (family related or not) as a long-term solution or temporary.
- **Family + Adult(s):** made by a family (couple or single parent with children) hosting an adult. This extra person can be blood-related with one of the family member, he/she can stay permanently or temporary.
- **Family + Family:** composed by different families living in the same household, each family can have or not children.
- **Family in unconventional housing conditions:** the category is made by people who lives together and they can not be classified in any of the previous category, since they are a mix of two or more of them. The category can include really different situation one to another.

The mapping wants also to confirm how these houses, designed years ago for traditional families, are not suitable for them anymore. The social and familiar changes require new kind of apartments, characterized by a layout that can be adaptable for any changes in life due to work, studies, familiar and economic reasons. Starting from the following questions “What profiles of inhabitants of the cities need to live in more than one home and/or to be temporarily accommodated? What are their conditions and needs? **How to provide them with appropriate and affordable housing solutions?** How to transform existing structures in order to respond to unmet need?” the students of “Re. Co.De 2018” gave an answer at the end of the Thematic Studio proposing a project of new homes for some of the users selected.

**TYPE A:  
SINGLE ADULT**



**TYPE B:  
SINGLE ADULT WITH A PLUS**

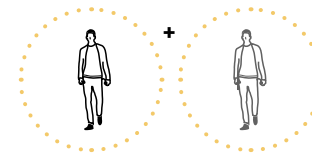

**TYPE C:  
ADULT(S) + ADULT(S)**

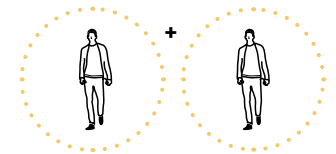

**TYPE D:  
COUPLE + ADULT(S)**



**TYPE E:  
FAMILY + ADULT(S)**



**TYPE F:  
FAMILY + FAMILY**



**TYPE G:  
UNCONVENTIONAL SITUATION**

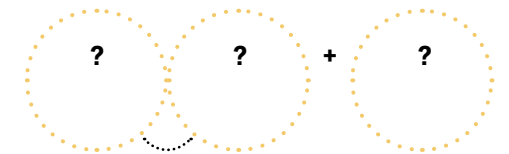

# TYPE A

## SINGLE PERSON

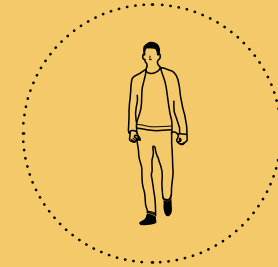

The category includes people who for personal reason or external forces are living alone; they can be students, workers or retired people. Their houses are not suitable for themselves for many reasons: students for saving money are force to live in apartments that are too small, with a layout bad designed that leads to a uncomfortable environment in living. Workers may have apartments that are too small for host their children in case of a divorce, or they may have apartments that are not suitable in terms of their habits. The retired people on the contrary are obly to live in their life house which is generally too big for they needs since children have left and the other partner may be pass away; the house also may be object of an intense modification in order to make it liveable for the elderly.

# CONNIE

Student,  
21 years old



1



Urbino, IT

Costanza, better known as Connie, is a 21 years old girl. She is from Milan, but at the end of the high school she decided to move in Urbino (Marche, Italy) to study History of Art. Connie is a positive person, very creative, in good vibes every day of the year. She enjoys cooking and eating, especially bakery products, she has many books about it and she likes to experiment when she has some free time. She lives alone, but sometimes she host some friends during the week, even if the space is really small. She has a pet, a rabbit called Lea, which moves free inside the apartment. She stays in Urbino for the whole semester and during holidays she came back to Milan.



1 room apartment  
17 m<sup>2</sup>



Bedroom  
14 m<sup>2</sup>



Bathroom  
2,5 m<sup>2</sup>



Living room  
14 m<sup>2</sup>



Kitchen  
14 m<sup>2</sup>



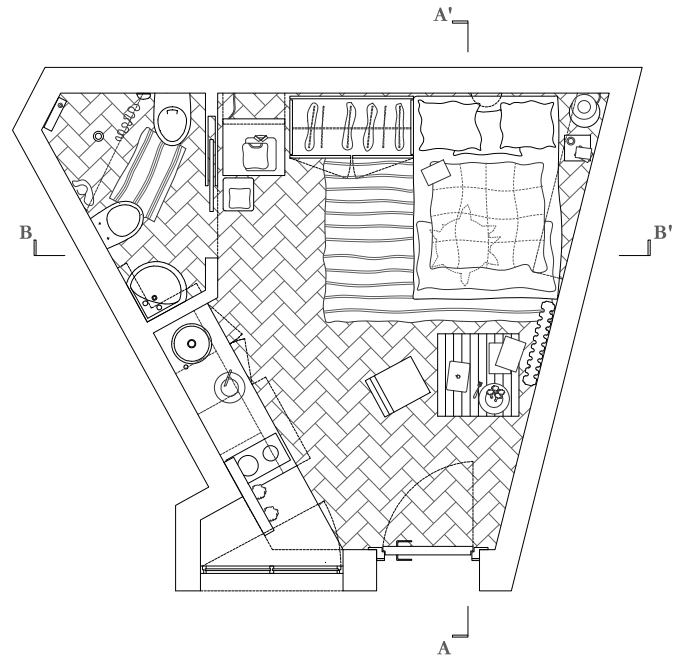

In this page: Ground Floor Plan  
 In the next page: First Floor Plan

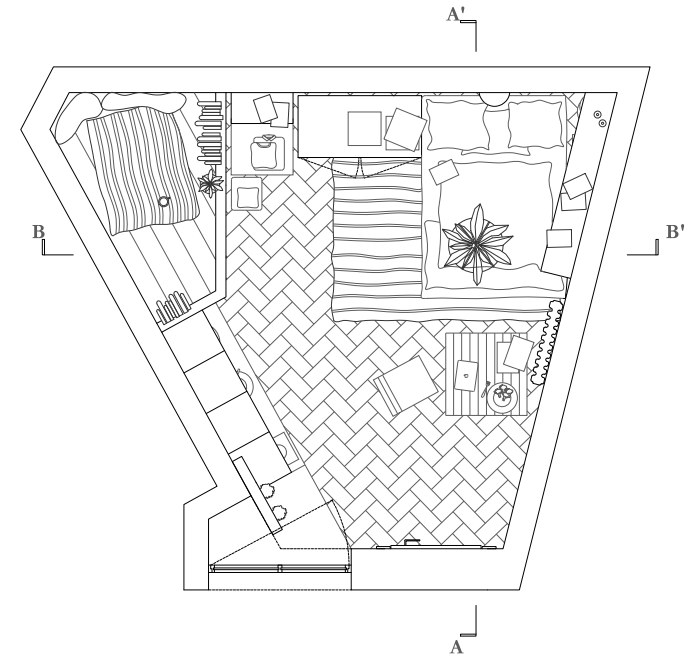
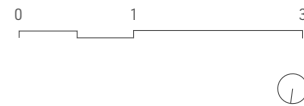

### Privacy levels

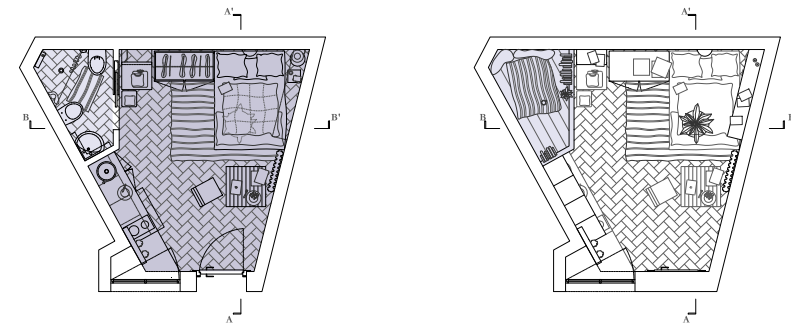

Less privacy  
 More privacy

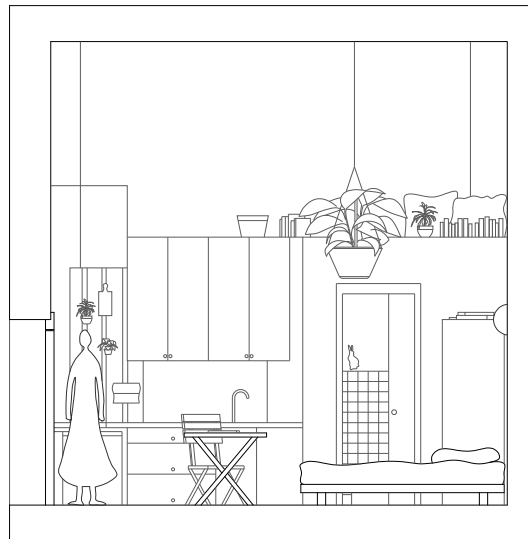

Section AA'

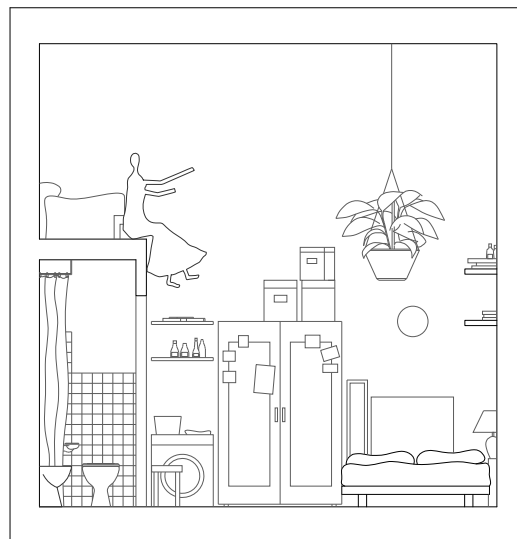

Section BB'

### An uncomfortable space

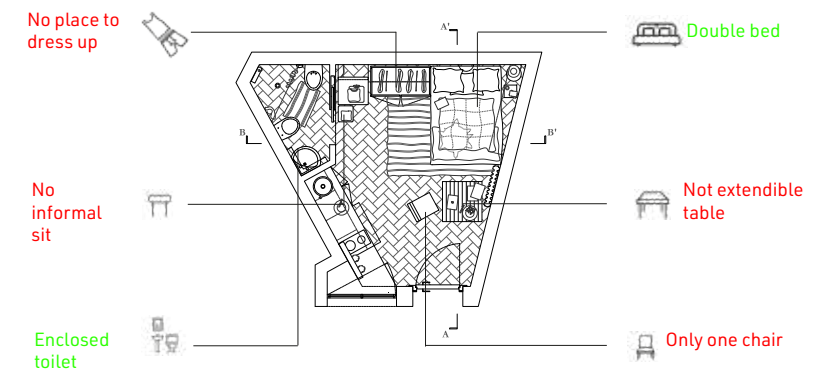

# LUIGIA

Widow retired,  
80 years old



2



Villasanta, IT

Luigia is 80 years old, she is a widow and a grandmother. She lives in Villasanta, a little town near Monza, where she was used to live with her husband until his death. She has two sons, Angelo (55 years old) and Franco (53 years old) and a daughter, Rita (48 years old) who live in the houses beside her. She also has six grand-child who often go to visit her. In the morning, she spends most of her time tidying up her house or cooking for her grandchildren who have lunch with her. In the afternoon she gets out and meet friends or she stays in the living room. She generally spends the evening alone. During the weekend she receive visit from her sons and daughter, who have lunch with her and spend some time together in the afternoon.



3 rooms apartment  
60,25m<sup>2</sup>



Bedroom  
17,57 m<sup>2</sup>



Bathroom  
5,86 m<sup>2</sup>



Living room  
19,22 m<sup>2</sup>



Kitchen  
12,70 m<sup>2</sup>





### Privacy levels

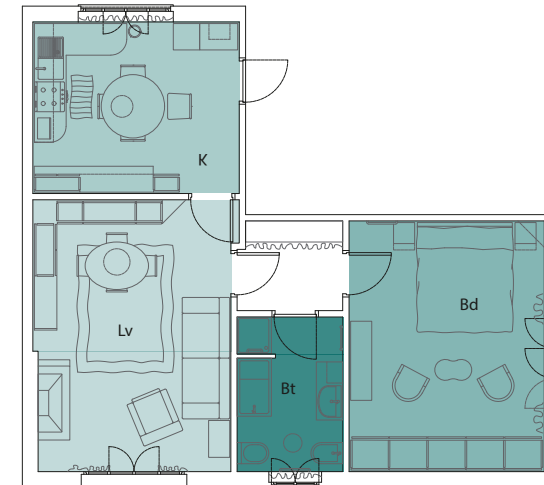

### An uncomfortable space

#### Disabled equipment

There are:

- disable handholds
- armchair for the elderly

Lack of:

- sofa bed to host a caregiver
- presence of a step as an obstacle
- space to move around with the wheelchair

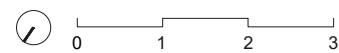
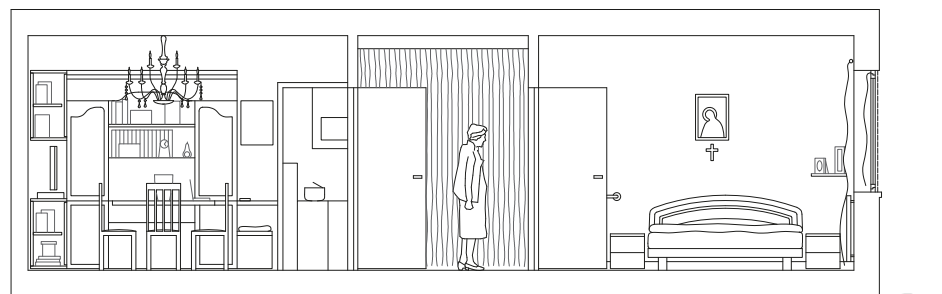
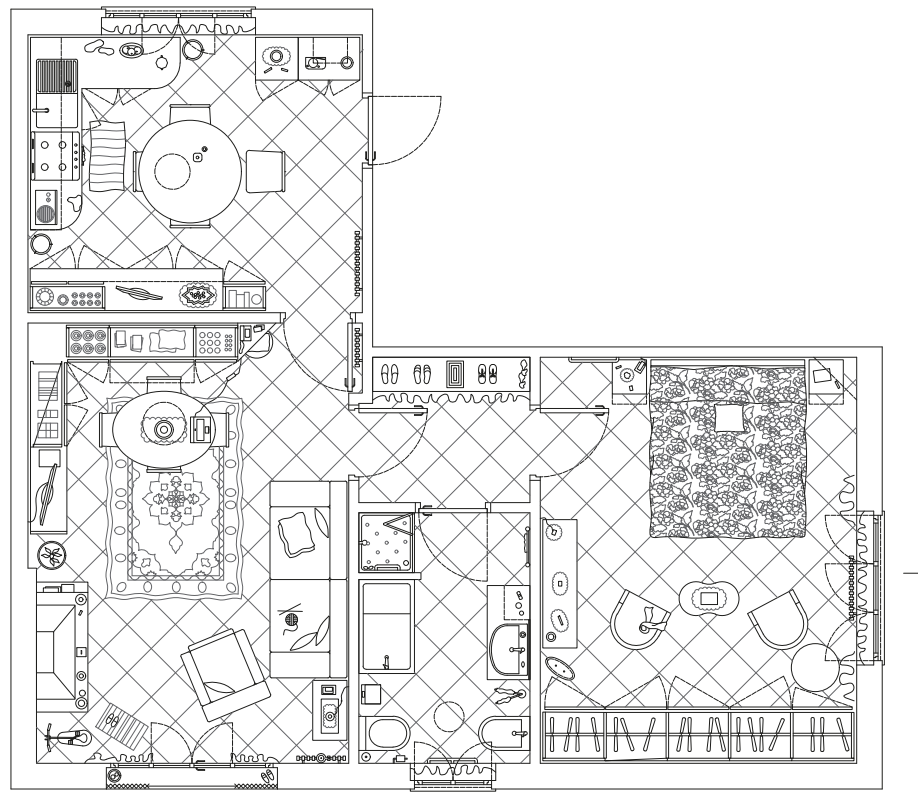
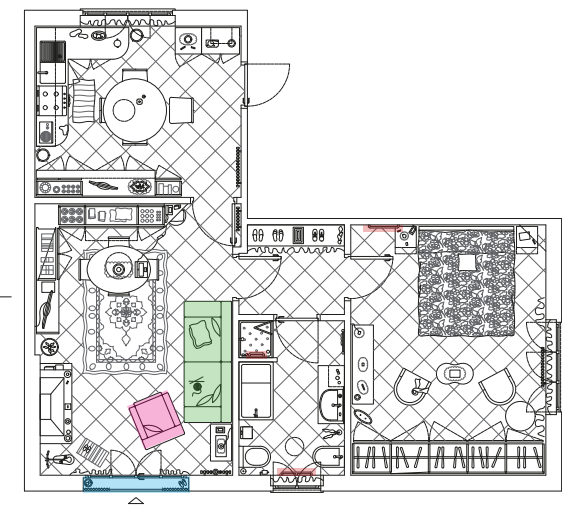

# ANGELO

Widow retired,  
81 years old



Corsico (MI), IT

Angelo is 81 years old, widower and retired, he lives alone in his apartment on the second floor of a building.

He has two sons, his daughter Annamaria 51 years and his son Antonio 49 years old; he also has four grandchildren, who very often during the week, have lunch to eat his place.

Every morning of the week his daughter brings him the dog to look after, while she is at work. He usually spends his morning cleaning the house and cooking to lunch for his grandchildren, who come to Angelo's house after school. Once greeted, he sits on the chair in the kitchen or living room to rest and sleep; before evening his daughter goes to his house to get the dog and then Angelo starts cooking in the kitchen for dinner.



3 rooms apartment

65,34 m<sup>2</sup>



Bedroom  
15,93 m<sup>2</sup>



Bathroom  
5,40 m<sup>2</sup>



Living room  
17,52 m<sup>2</sup>



Kitchen  
10,38 m<sup>2</sup>

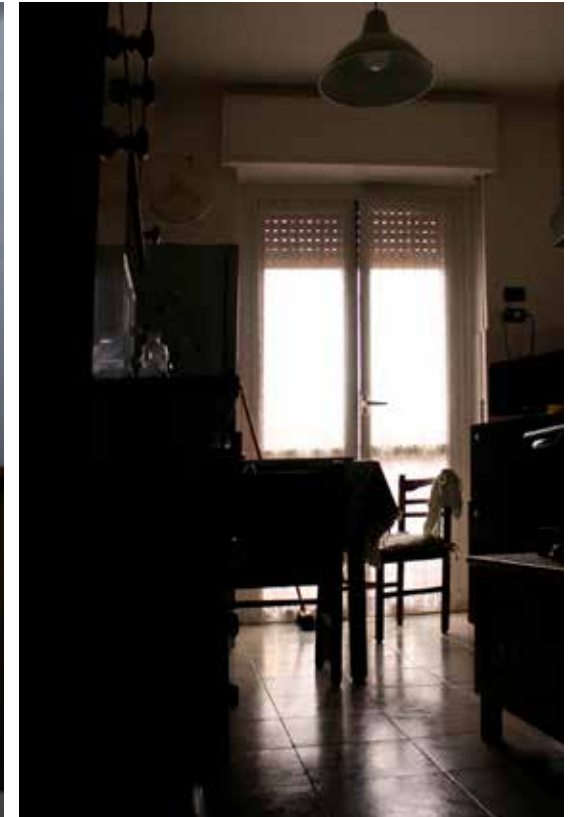

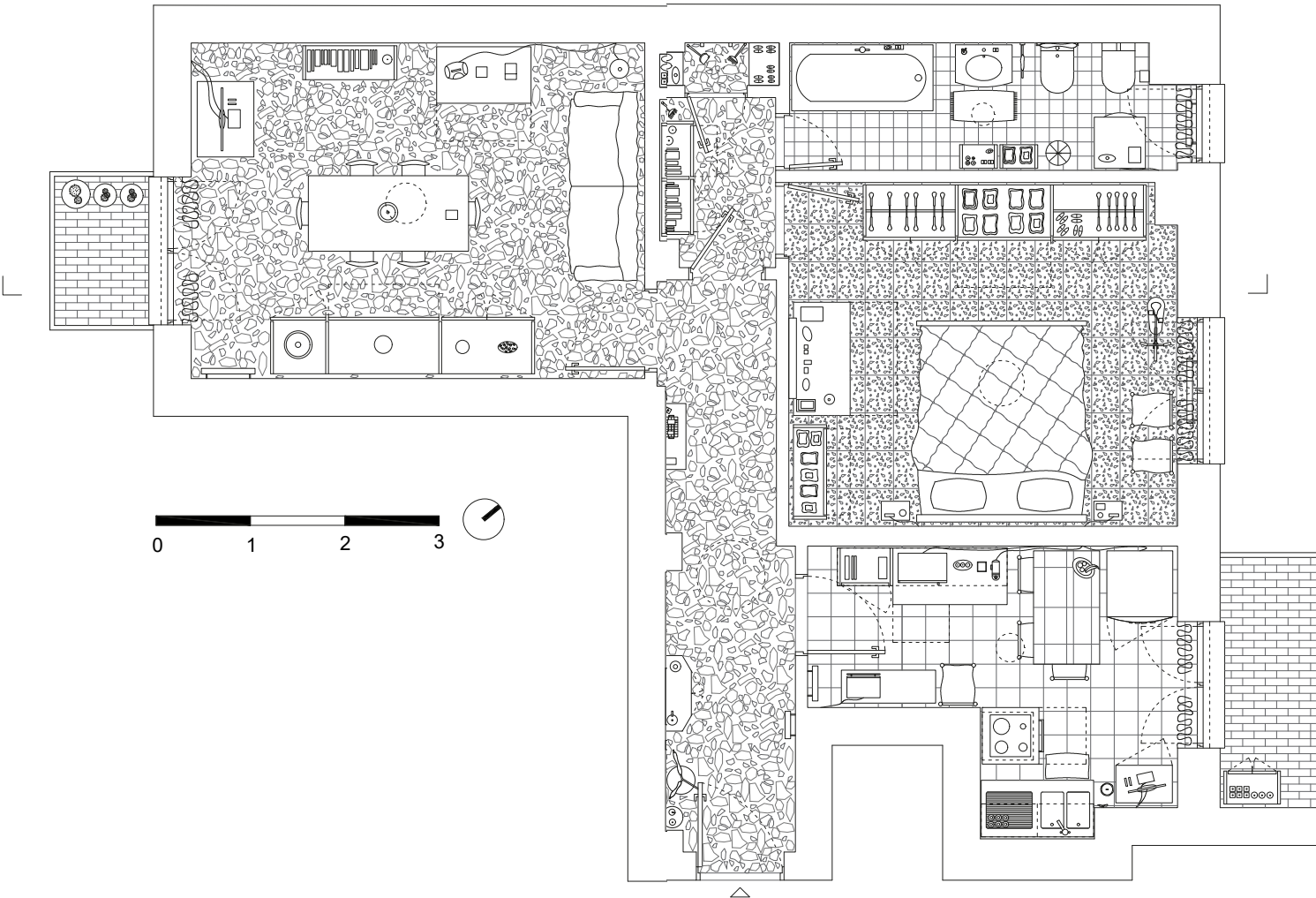
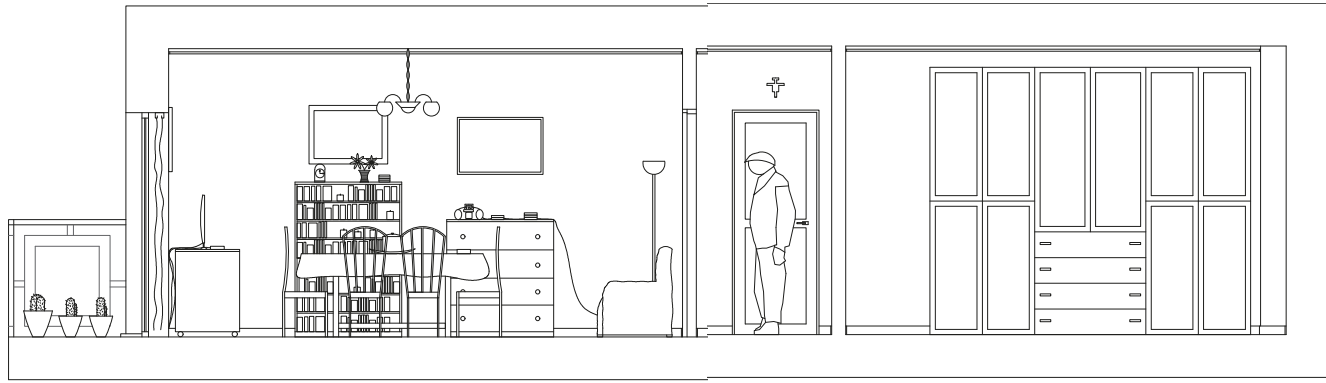

**Privacy levels**

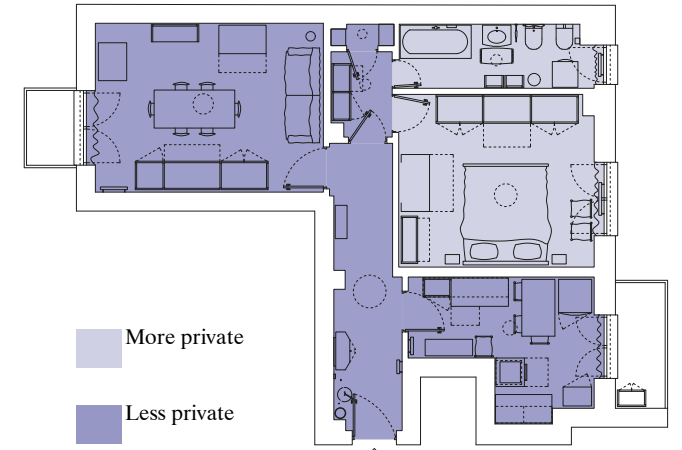

**An uncomfortable space**

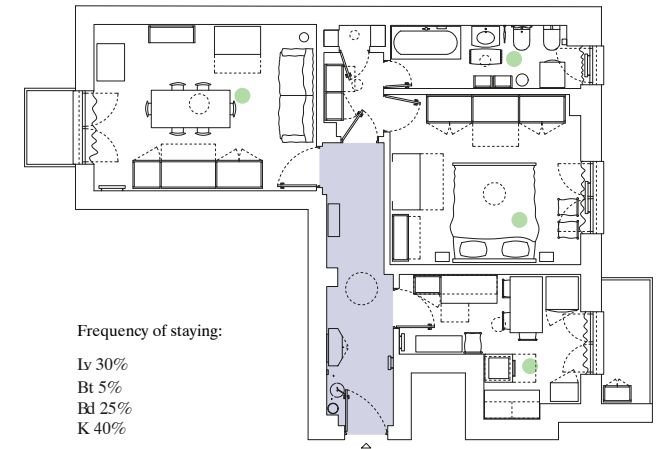

# ANDREA

Nurse, Divorced  
50 years old



Bellinzago Lombardo (MI), IT

Andrea is fifty years old and he lives in Bellinzago Lombardo (MI) in a house rented after the divorce. He is a Nurse and because of his job his daily routine is not regular. He is a very creative person and during his free time, he creates home furnishings, especially lamps, made of wood, concrete or cardboard, or other time he is a photographer with a friend for events and weddings' photo shooting. Andrea spends most of his time in the living room- kitchen, where he exhibits his furniture and photography works and where he produce his furniture. He also use a lot his bedroom for post production of his photos. Andrea has a daughter, Diletta, who is 21 years old, she lives with her mother but sometimes she spends the night at Andrea's. In this case she sleeps on the sofa since there is not an extra room.



2 rooms apartment

60 m<sup>2</sup>

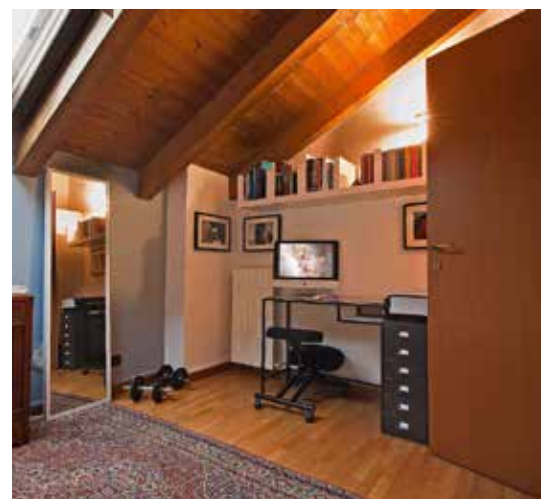
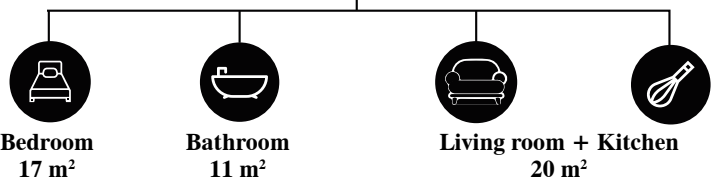

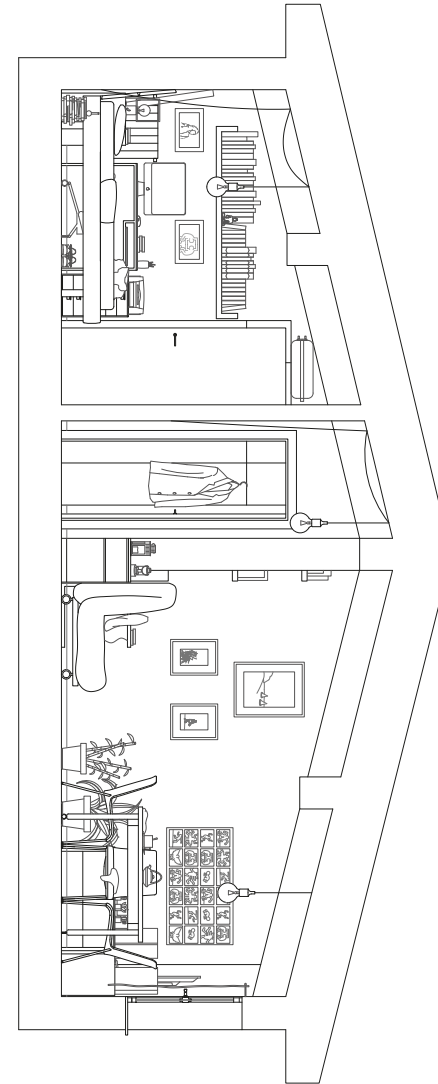
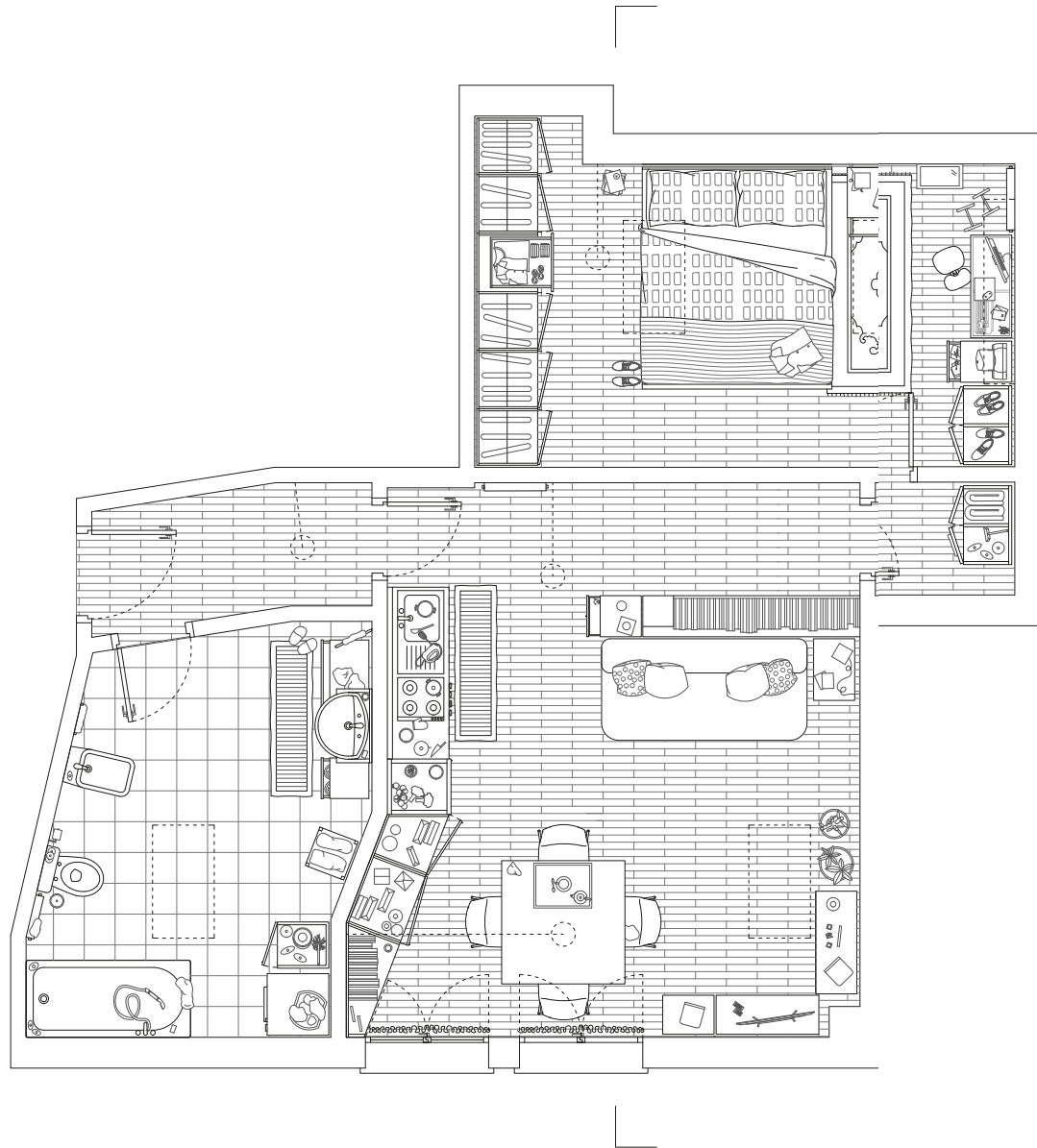

### Privacy levels

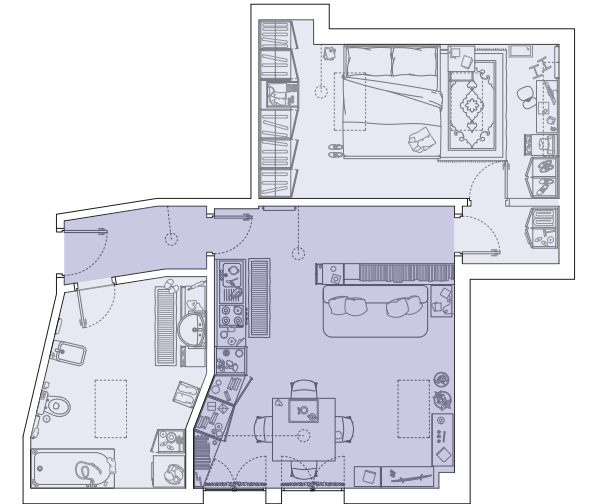

PTX 71

More privacy

Less privacy

### A lack of privacy for Diletta

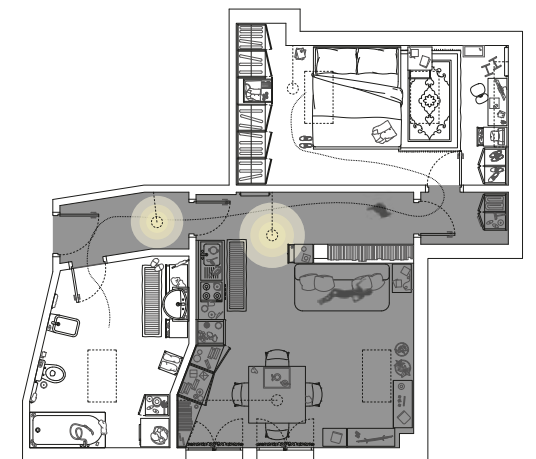

When I spent some days at my father's home, I sleep in the most public space of the house. For this reason, I have not enough privacy so, for example, if he wakes up during the night, the light will annoy my sleep.

# DIMITAR

Teacher, Divorced  
71 years old



5



Sofia, Bulgaria

Dimitar is 71 years old he lives in Sofia by his own since the divorce with his wife. He is father of two sons and he has two grandchildren. He likes philosophy, photography and art. He does not spend much time in his apartment, which is too big for him. He generally stays out until dinner, after he watches tv or reads a book. His family come to visit him on sunday when they have lunch together. The apartment is 250 sqm and it was perfect for a family with two children, now that he lives alone, Dimitar transform the child's room in the guest room



3 rooms apartment  
250 m<sup>2</sup>

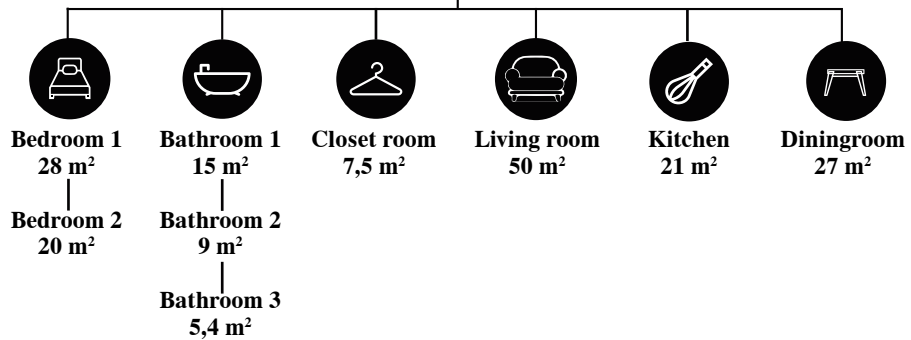

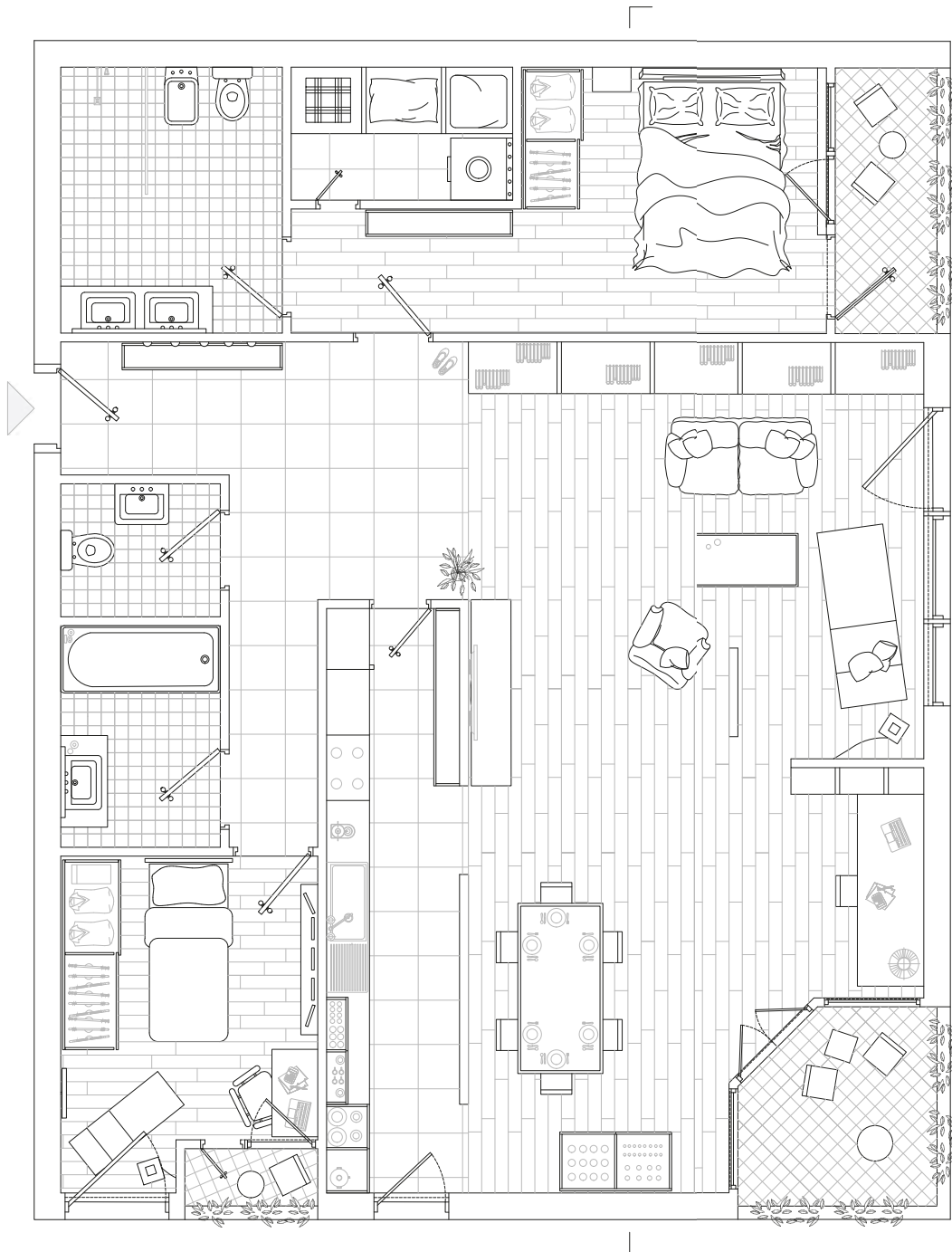

Scale 1:50

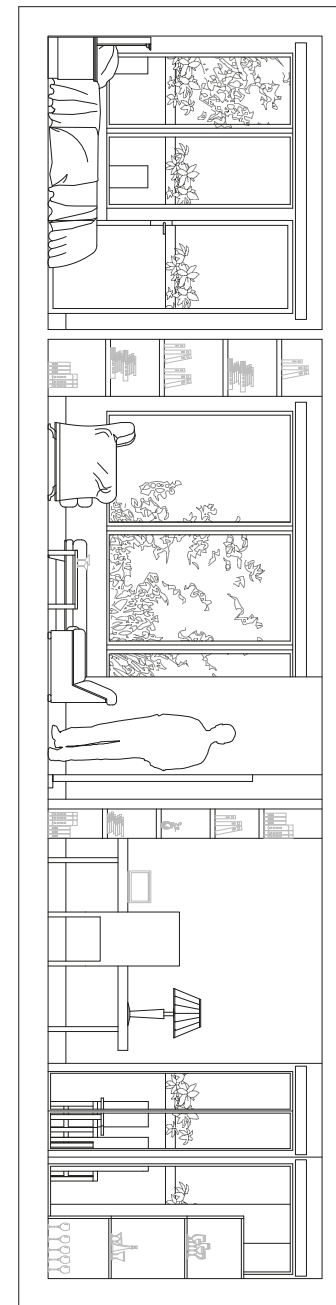

### Privacy levels



More privacy    Less privacy

### An uncomfortable space

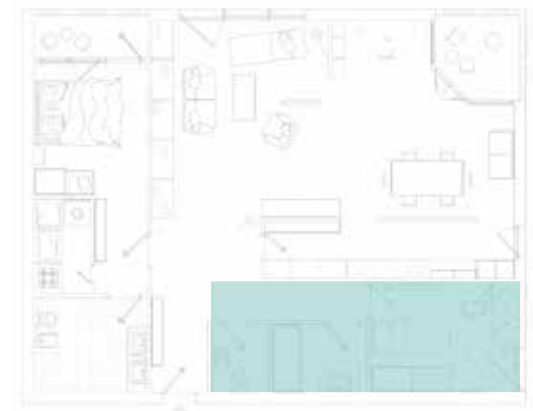

Unused space

# RITA

6

Post office worker  
28 years old



Legnano (MI), IT

Rita is a girl of 28 years old who moves from Naples to Legnano for work. She is a quiet girl, with a sedentary life and she loves to stay alone. She lives alone in a quiet neighbourhood, but sometimes she hosts a friend for dinner.

She has all the rooms she needs in the house: one bedroom, one bathroom, one living room, one kitchen and a small space for cleaning supplies. She loves living there, but sometimes she feels the loneliness; she also complains about the separation between the kitchen and living room, since she would prefer a unique space.



1 rooms apartment  
63,8 m<sup>2</sup>



Bedroom  
17,6 m<sup>2</sup>



Bathroom  
7 m<sup>2</sup>



Living room  
7,3 m<sup>2</sup>



Kitchen  
5 m<sup>2</sup>





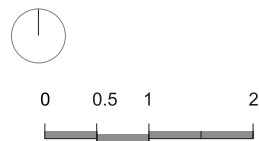
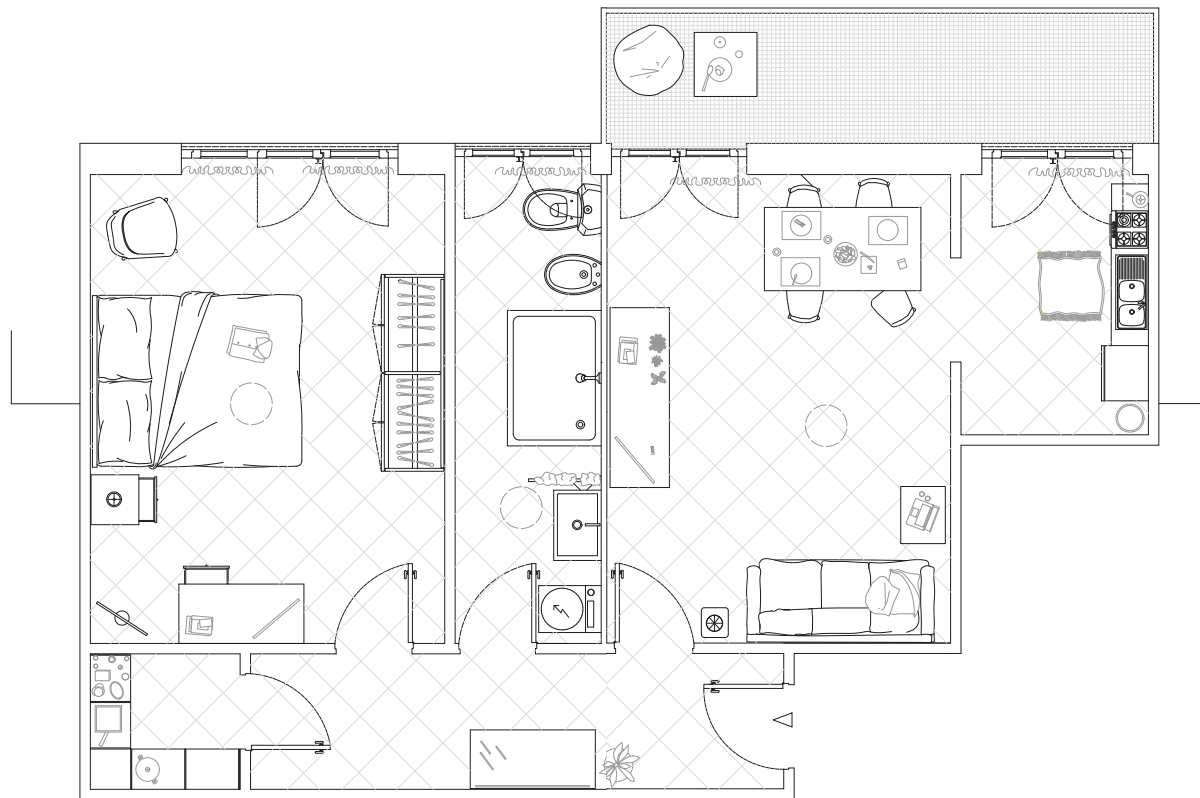

### Privacy levels

- Common area
- Private areas



### An uncomfortable space

- Powerfull rooms
- Rooms with conflicts

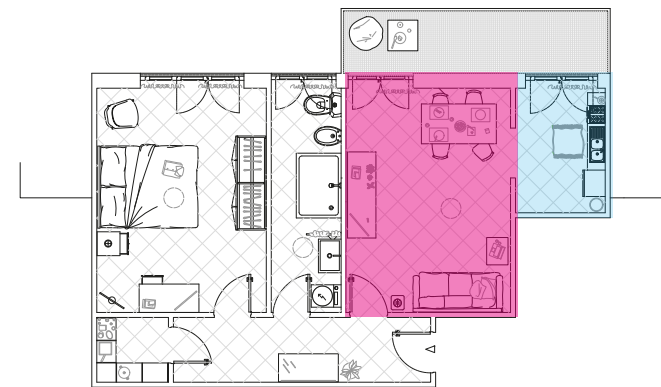

# TYPE B

## SINGLE ADULT WITH A PLUS

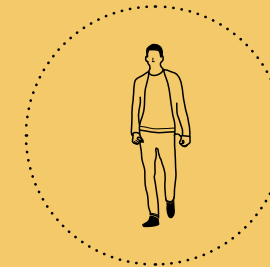

X 2

This category consists in single adult people living together. They may be blood related, siblings, mother and adult child or grandmother and nephew; but they can also be strangers or containing LAT couples without children. These people are sharing an apartment and they may find some problems in the respect of their space and their privacy. They have different ages and habits and this have to coincide with the space that the house offers, sometimes with problems. Some of this people, are forced to have guest, like the elderly: obligate by the family or by their physic condition, they require the assistant of a caregiver who lives with them. Other people are also single parents with adult children that are permanently living together or just some days a week due to a divorced or other reason. It can also include conditions where a grandmother is living with her nephew, reasons may be different but the choice of living with a member of the family help the members to support and take company of each other.

# GIUSEPPINA & NADIA

1

Retired, Caregiver  
85 years old, 50 years old

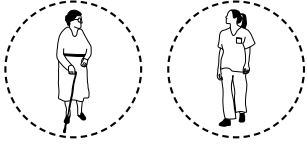

Cene (BG), IT

Giuseppina, called Pina, is a widow woman of 85 years old. She has four children, three daughter and one son, who live in the town immediatly. She had a bad accident that does not allow her to make many activities and movements, and for this reason she is living with Nadia, a caregiver. Nadia came from Ukraina in 2011, she has 50 years old, she has a husband and a daughter that are waiting her in the original country. They are living together but their relationship is not good: Pina is not happy to have a not blood related person in the house, while Nadia has some problems to make her understand her responsibilities. She takes care of here every day except the weekend and two hours after every dinner; they spend most of the time in the dining room and the kitchen since they don't have a proper living room.



3 rooms apartment

82,18 m<sup>2</sup>



Bedroom  
15,6 m<sup>2</sup>

Bedroom  
14,4 m<sup>2</sup>



Bathroom  
7,47 m<sup>2</sup>



Cellar  
12,83 m<sup>2</sup>



Living room  
11,41 m<sup>2</sup>



Kitchen  
+  
Dining room  
16 m<sup>2</sup>



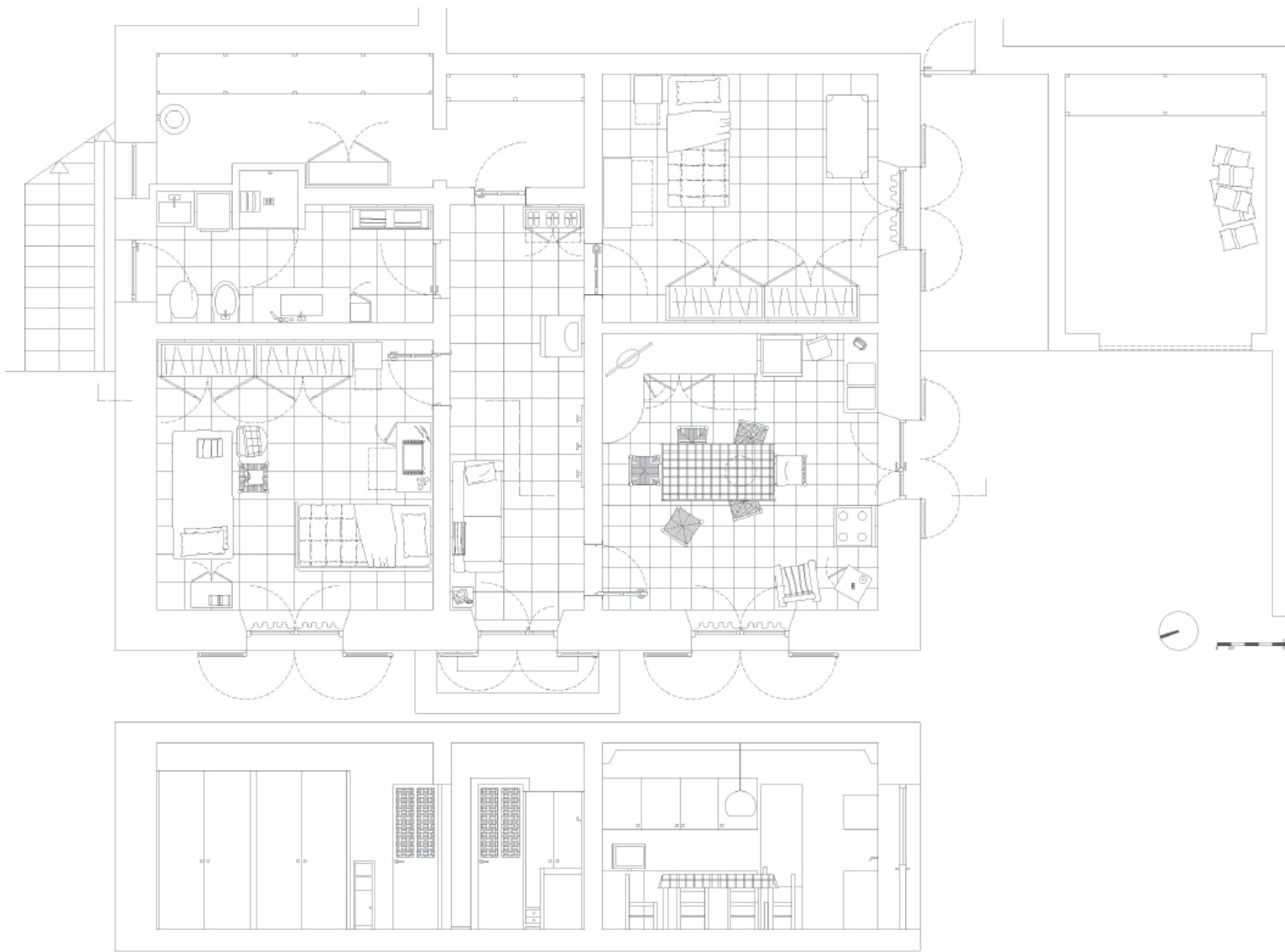

**Privacy levels**



- More private
- Less private

**An uncomfortable space**

Create more space for Nadia, not only her bedroom

Create a space in the outside for Giuseppina, so she can move over the house but not in the town

# TEA & DOROTEA

Dogkeeper, Student  
28 years old, 13 years old

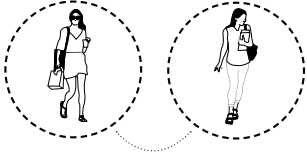

Milan, IT

The women are living in Milan and they are mother and daughter. Tea works as dog keeper in the entrance of the building where they lives, from 10 am in the morning until the evening, while Dorotea is studying at the middle school from monday to saturday. They share a common passion: rugby and gym, both of them attends trainings and matches. They lives in a small house, where they spend the most of the time in the kitchen and living room.



2.5 rooms apartment

55 m<sup>2</sup>

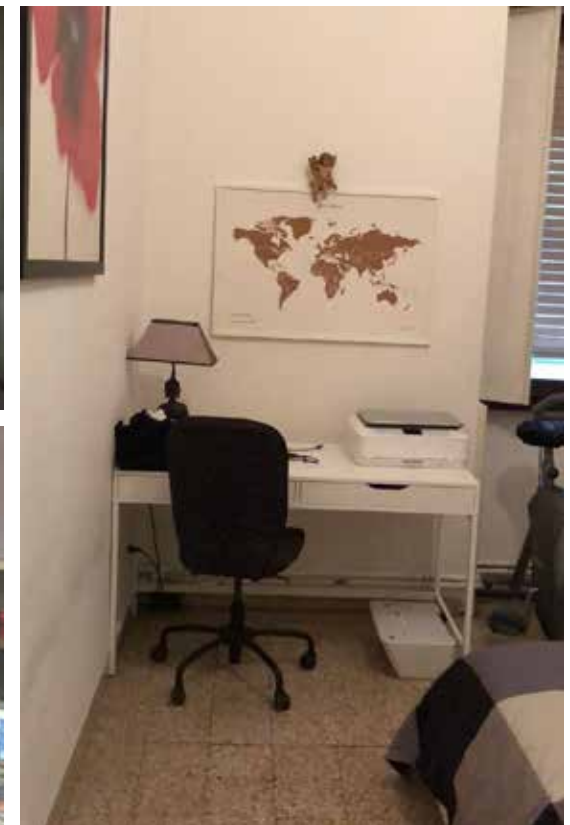
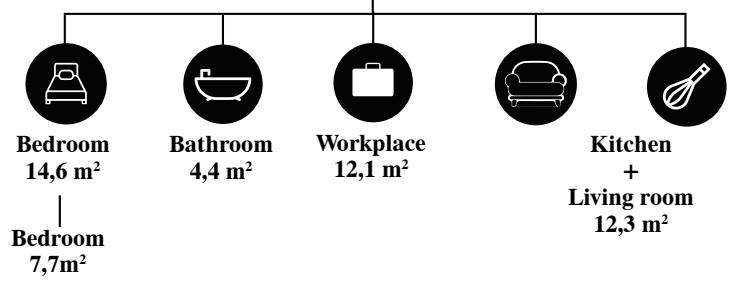

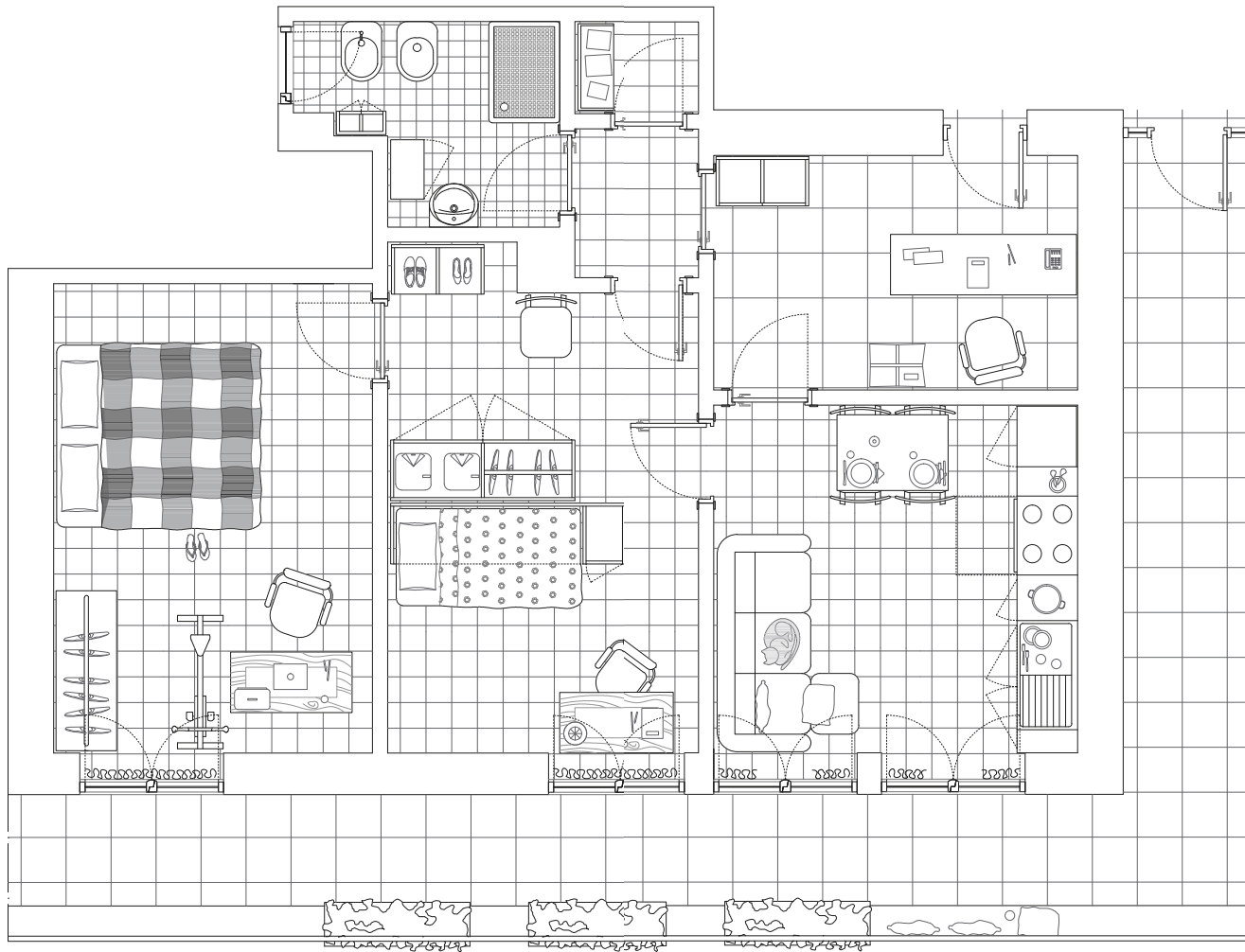

### Privacy levels

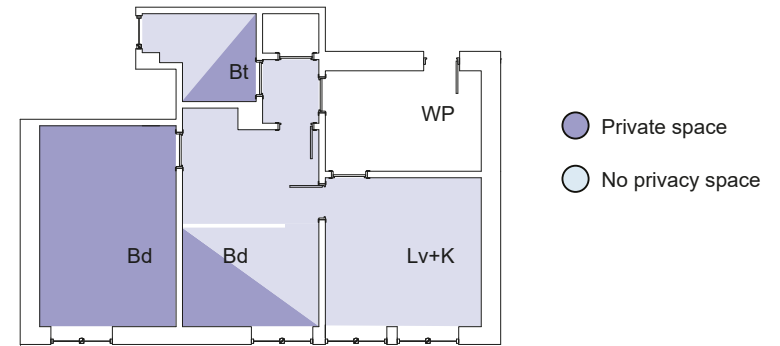

### An uncomfortable space

Morning Routine before work / school

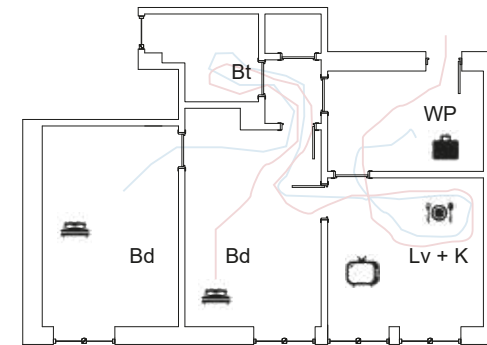

# ANTONIO & ANNARITA

Retired, Teacher  
62 years old, 55 years old



Brindisi, IT

Antonio was a sailor, from three years now he is retired. He built with his hands the house where he is living, located in the countryside. He is a good welder and since he is not working anymore, he is dedicating a lot of time to his hobbies. Annarita the wife, is a teacher in the elementary school, she loves reading and literature. She lives in the countryside with her husband only in the weekend, because for work and personal reasons she decide to live in the city centre where she works. The house where they live together does not help their different activities and behaviour: there is not a sofa that can let the couple relax together, an extra room is missing for Annarita to give private lessons for the children who needs, the house has many Antonio's tools around and there is a lack of space in the dining and living room for receiving their son and grandchildren



## 3 rooms apartment

100,7 m<sup>2</sup>



Bedroom  
23,82 m<sup>2</sup>



Bathroom  
5,07 m<sup>2</sup>



Front porch  
25,63 m<sup>2</sup>



Living room  
25,83 m<sup>2</sup>



Kitchen  
14,55 m<sup>2</sup>

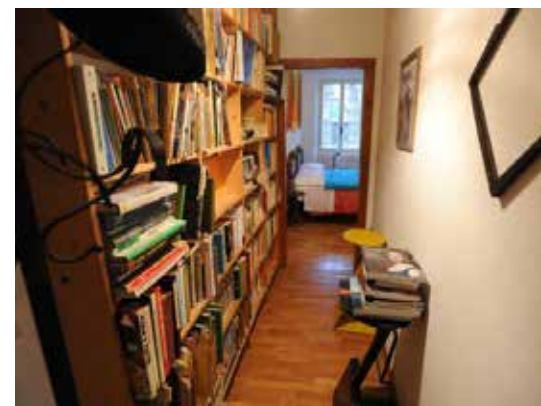

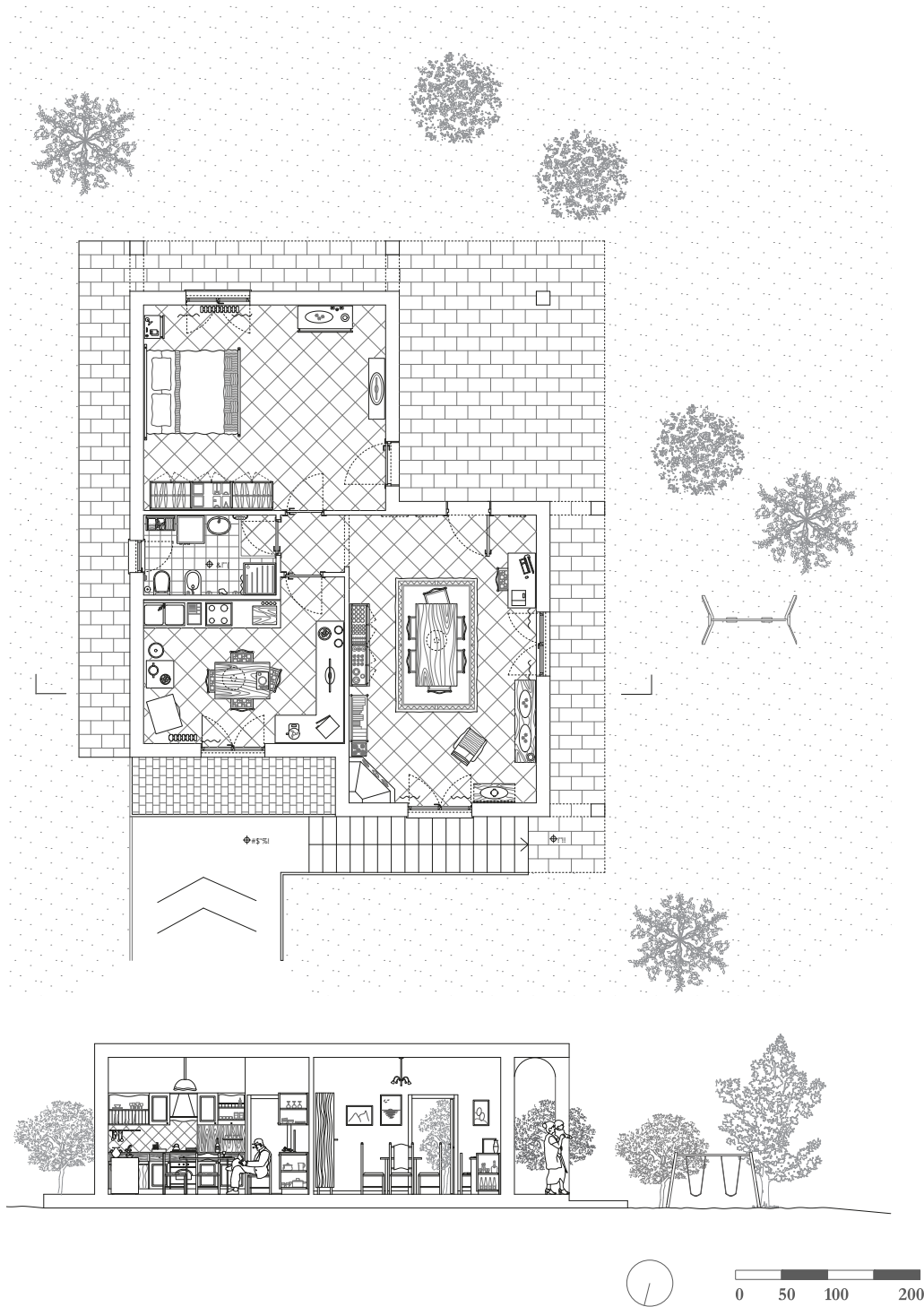

### Privacy levels

- less private space
- more private space

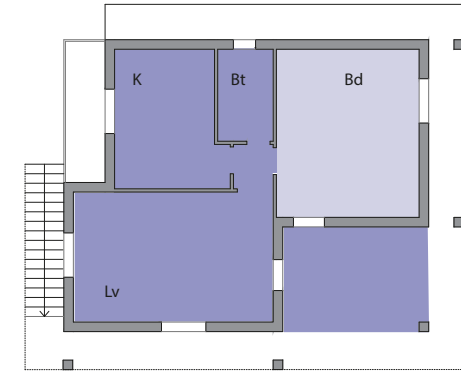

### An uncomfortable space

#### Problematic Space

Lv There isn't a sofa, and they couldn't relax together.

There aren't enough space around the table for all the relatives.

Bd The bedroom : big space but no extra bed for their nephew or the son.

No private space for Annarita.

#### Possible Solution

Lv Sofa for two person  
Comfortable table to have a dinner

Bd Single bed for the guest.  
Shelves for the books of Annarita

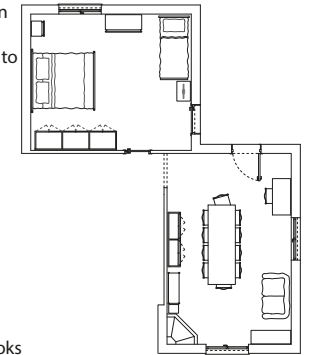
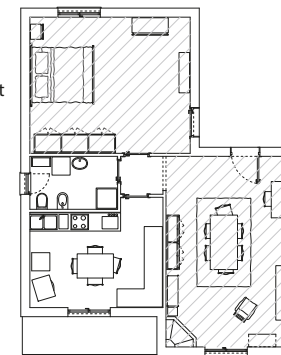



# CLARA & NICHOLAS

4

Housewife, Worker  
68 years old, 24 years old

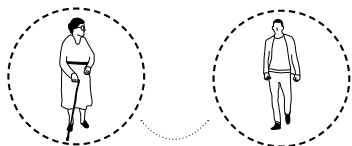

Arezzo, IT

Nicholas is a head machine in a coffee factory, during his few free times he likes to go to the gym or spend time with his friends. Clara is a modern grand-mother. she is energetic, active and open-minded. She likes travelling and doing many homes duties and activities related. Her and Nicholas have a strong relationship and this help them to live together. Nicholas spend the most of his time in his bedroom, while Clara in her bedroom and in the living room, the only common space in the house. Sometimes is hard for Nicholas to invite friends at home for her grandma presence, she also has to adapt her activities in consequences to Nicholas. They complain that the house is too small for two people with different needs.



2 rooms apartment

73 m<sup>2</sup>



Bedroom  
14 m<sup>2</sup>

Bedroom  
11 m<sup>2</sup>



Bathroom  
5 m<sup>2</sup>



Terrace  
7 m<sup>2</sup>



Living room  
17 m<sup>2</sup>



Kitchen  
12 m<sup>2</sup>



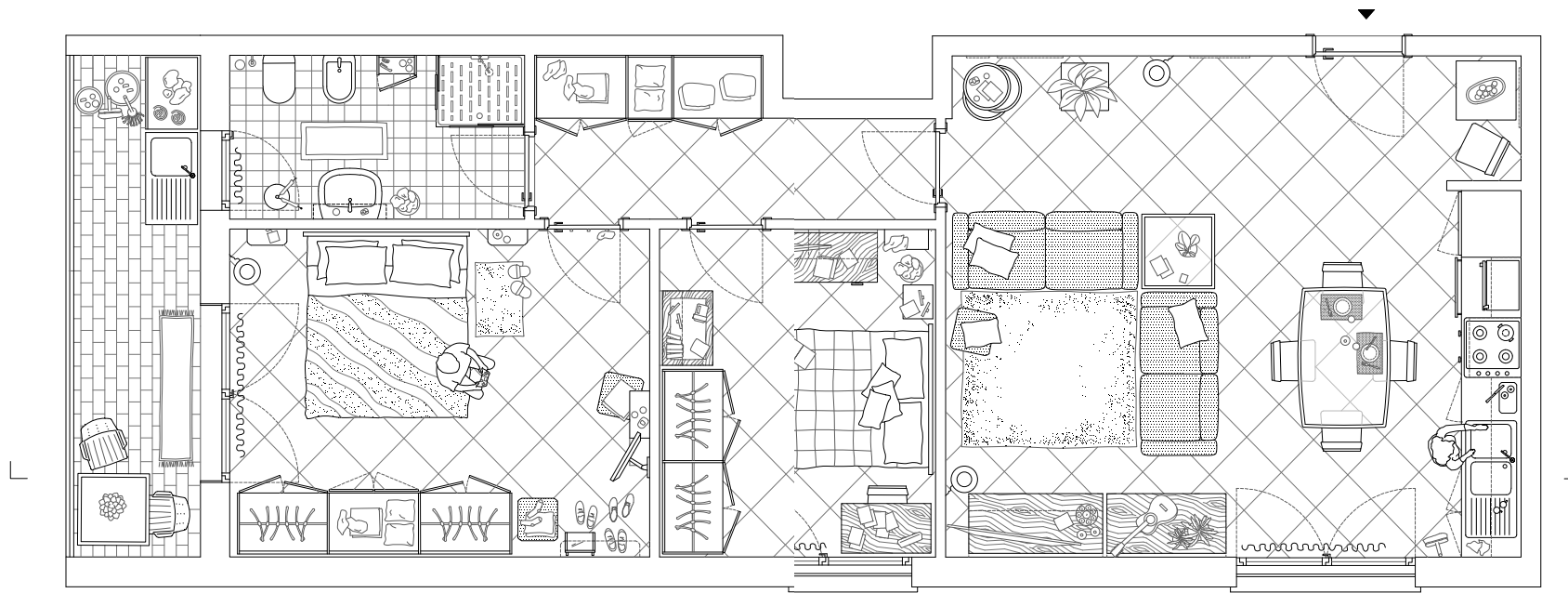

**Privacy levels**

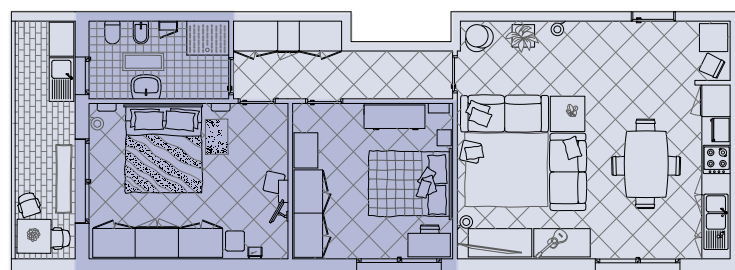

**An uncomfortable space**

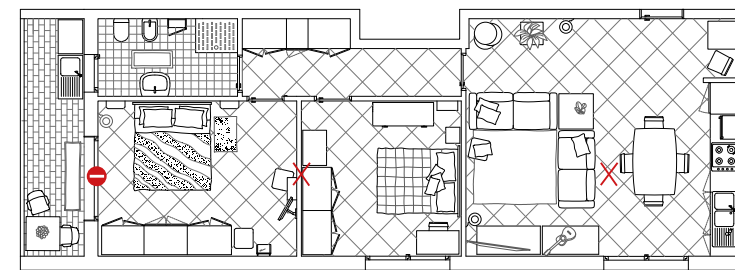

Too close spaces: reduced accessibility and no total freedom on movement → Lack of spaces for second need, different from the basic and primary one

# ALBERTO & FRANCESCA & ALESSANDRO

Employed, Student, Student  
51 years old, 15 years old, 8 years old



Valbrembo, IT

Alberto got divorced five years ago, he lives in Valembro and he works as employed in Villa d'Alme since 1987. He has one daughter Francesca of 15 years old and a son, Alessandro of 8 years old; both of them are really energetic and they are passionate to sports, like the father. Alberto is running in a team and he is also playing guitar. The children stays in the father house during the weekend. The house has minimal furnitures and it is really organized, with the exception of the sons' bedroom that is full of toys and other things for him. What concern Alberto is that in 10 years he will need to reinvent the room in order to satisfy the necessity of the kids that will be young adult with different needs than now.



4 rooms apartment

72 m<sup>2</sup>



Bedroom  
12 m<sup>2</sup>

Bedroom  
17 m<sup>2</sup>



Bathroom  
3,8 m<sup>2</sup>



Terrace  
6 m<sup>2</sup>



Living room  
22,6 m<sup>2</sup>



Kitchen  
10 m<sup>2</sup>



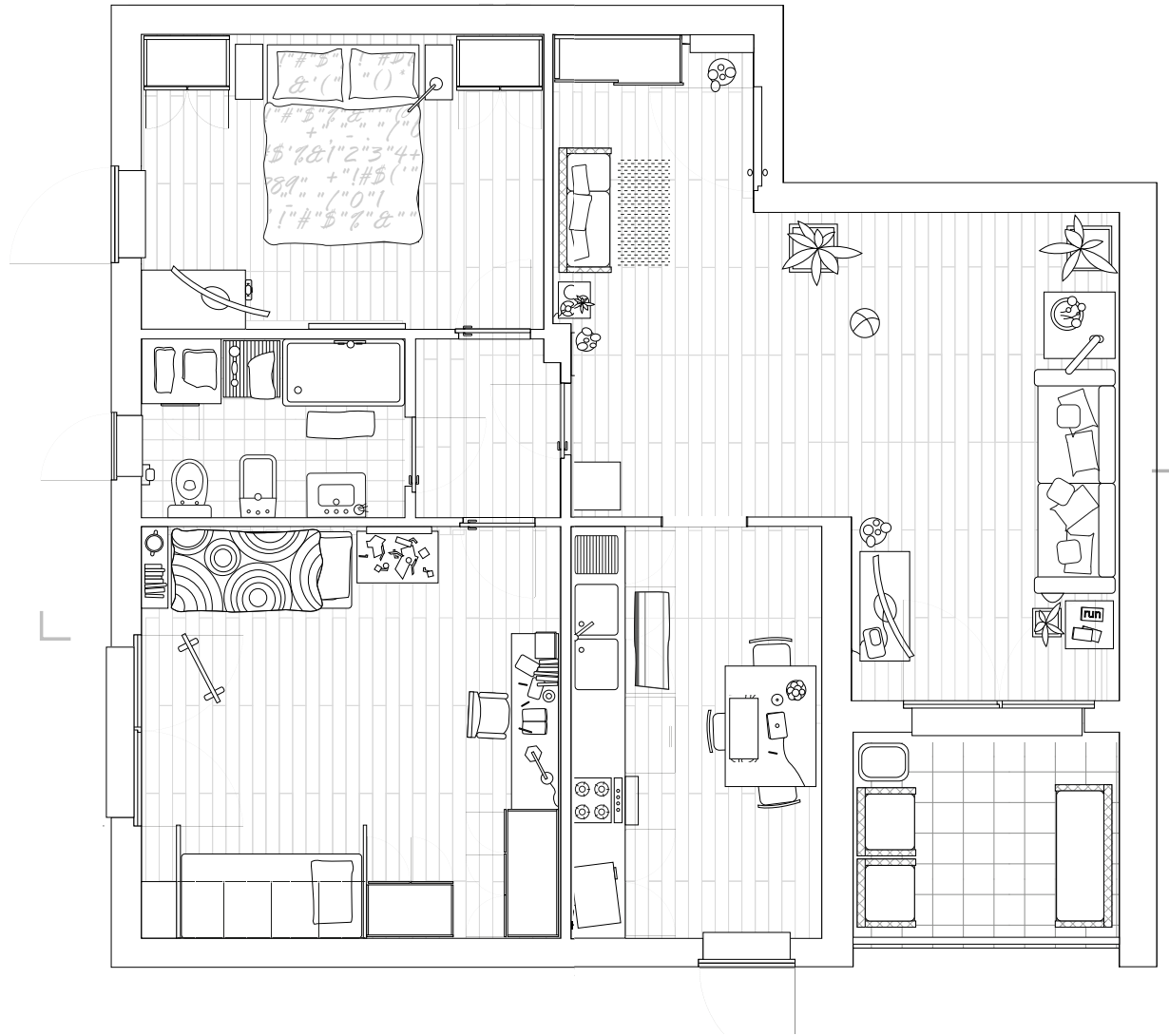

**Privacy levels**

- More private
- Less private

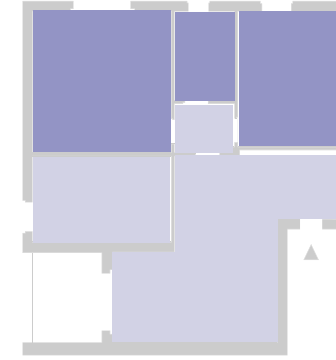

**An uncomfortable space:  
children's use**

- Intense
- Few

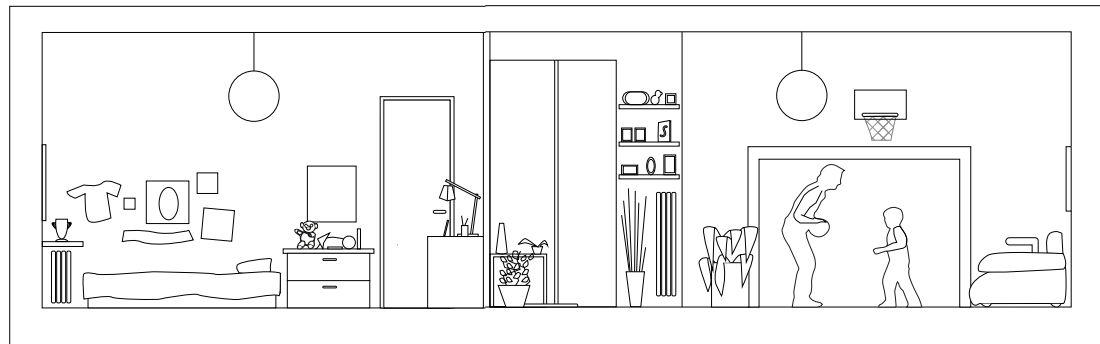
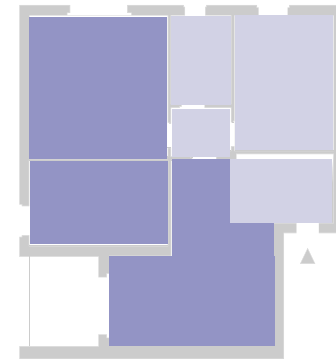

# LUISA & PEPE & PATRICIA

Worker, Retired, Caregiver  
48 years old, 91 years old, 34 years old



Ávila, Spain

Pepe is a retired man of 91 years old; he had been working until the age of 54 when he had to stop for a work accident. He was married with a woman, Saturnina, who died five years ago. He likes walks in the town and meet his friends in the elderly centre, where they play cards and do dance classes. Since a couple of years he is having problems in doing normal activities, so Patricia, the caregiver who assisted Saturnina, moves to his flat and take care of him from monday to friday. Luisa is Pepe niece, she comes in the weekend to take care of him, she spends all the time that she can, but she does not stay often to sleep, in this case, she sleep in Patricia's bedroom. Patricia and Luisa are the only one who are using all the rooms in the house, while Pepe stays only in his bedroom, in the living room and the bathroom.



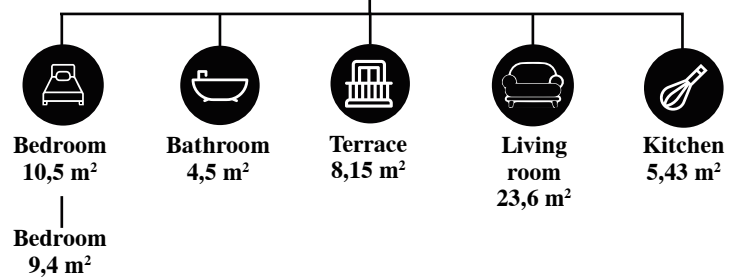

**2 rooms apartment**  
**68,1 m<sup>2</sup>**

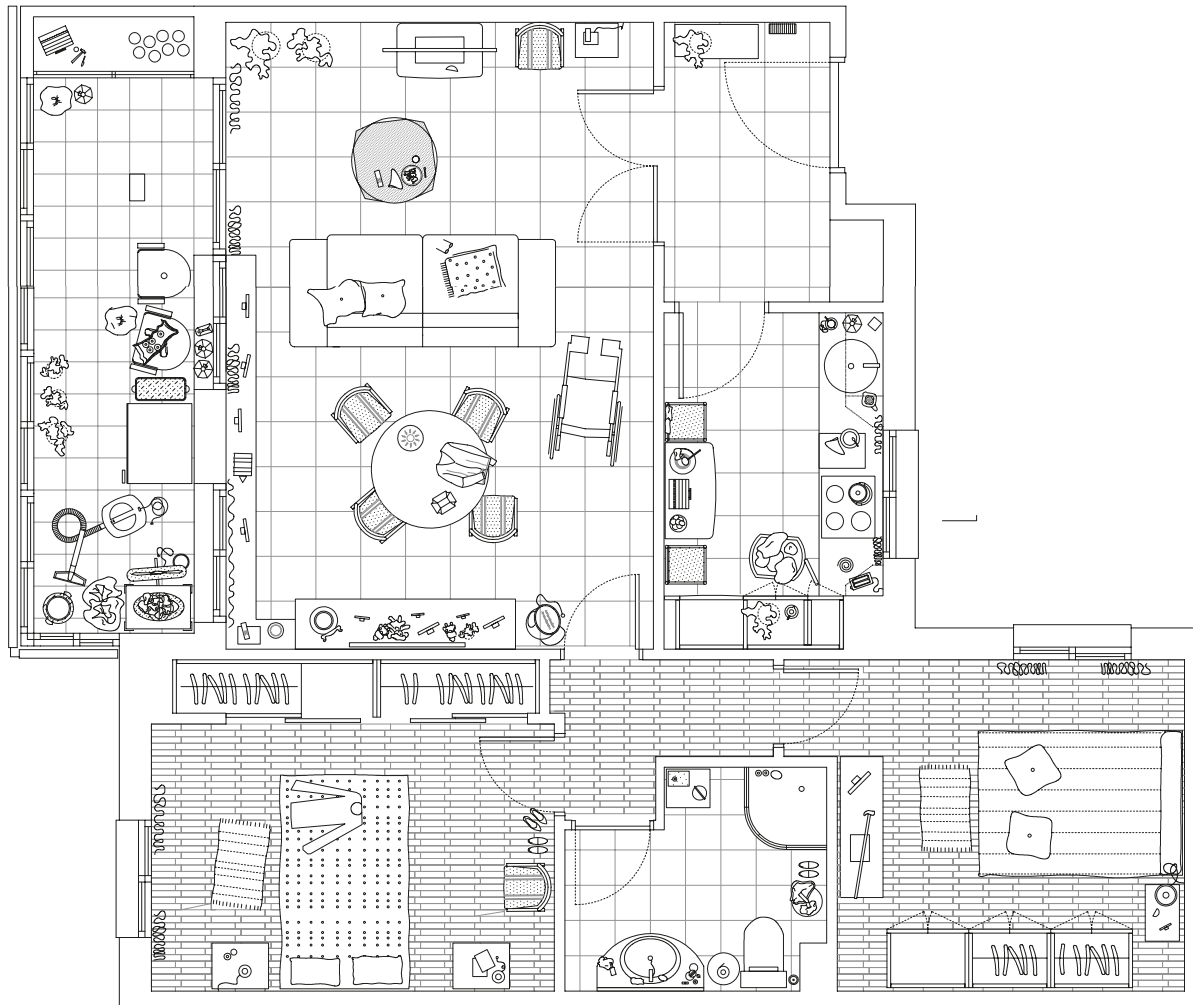
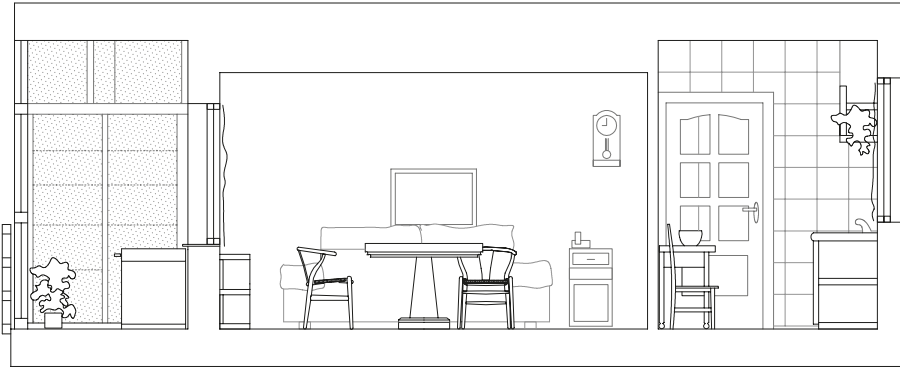



SCALE 1:50 0 1 2

### Privacy levels

Less private   
 More private 

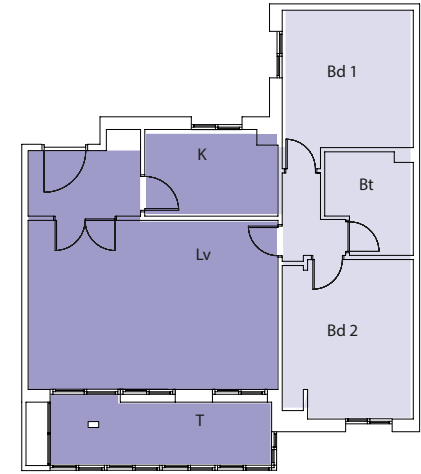

### An uncomfortable space

#### Accessibility

 accessible space

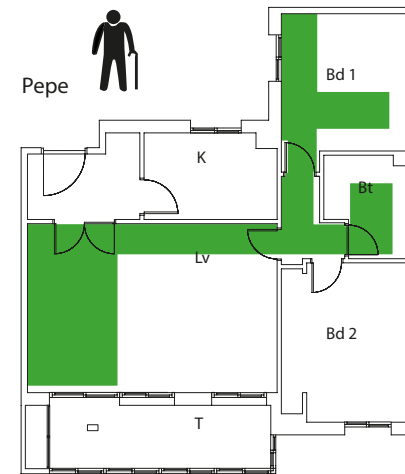

#### Privacy

 possible conflict  
 personal space  
 sharing space

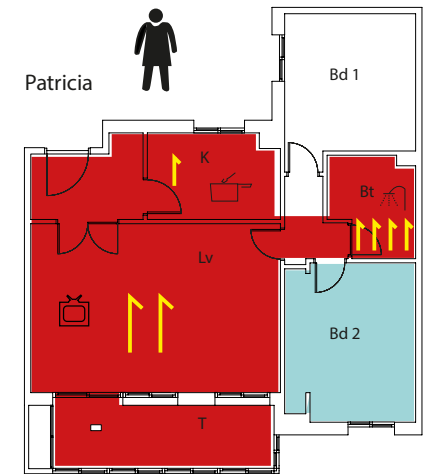

# TYPE C

ADULT(S) + ADULT(S)

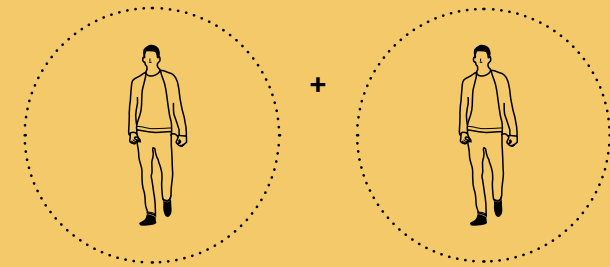

The category contains single independent adults that decide to live together. In most of the case they are not blood - related, if they are, they are brothers and sister or parent and adult son. The difference with the category Adults with a plus is that in this case the members of the households have an independent life one to another; moreover, they are living together as a common and definitive decision, while in the other case members may not have an independent life from one another and they may be forced to live together. In the typology of adults + adults the presence of an uncomfortable space and the lack of privacy are affecting deeply the living conditions of the house.

# ANTONELLA & MARIA

Secretary, Dental assistant  
21 years old, 21 years old, 22 years old

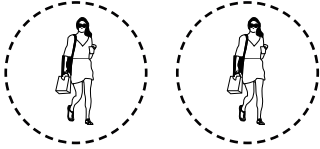

Rome, IT

Maria is a 51 years old woman born in Sicily; she moved to Rome when she was 27 to look for a job; after seven years she meet Antonella and they decide to divide the house as room-mates. They have many interest in common and they are close friend, in particular both of them practice meditation and they believe in Buddhism. Antonella works as secretary, but she has many passions outside work, like doing mosaic; for this reason, she has a room as studio where she can experiment his artistic work. They live in the African neighbourhood; this cohabitation was supposed to be a temporary solution, but in the end, it is long by seven years now. Divide the same bedroom and house is particularly difficult for the lack of furniture and the bad layout of the house; moreover, the shared bedroom does not allow much privacy.



4 rooms apartment  
70 m<sup>2</sup>

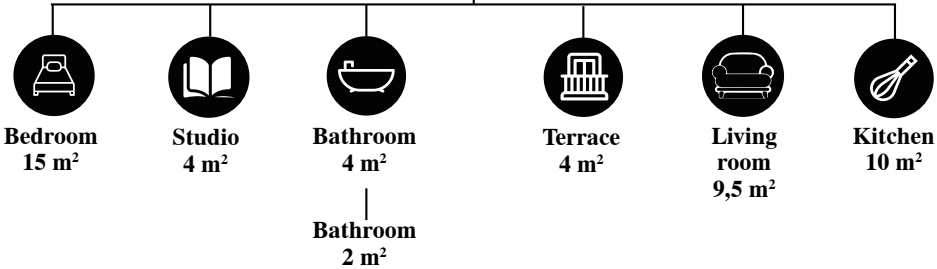



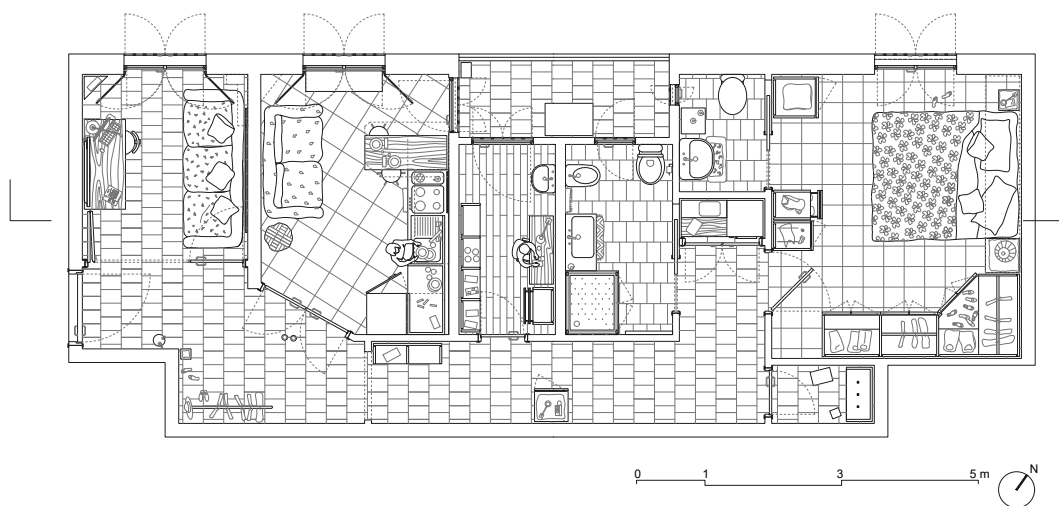
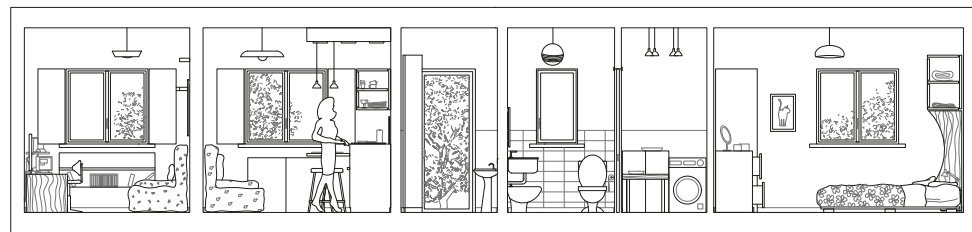

## Privacy levels

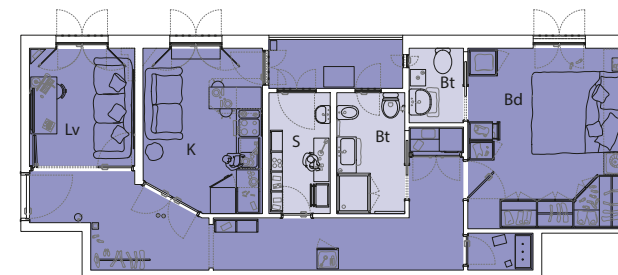

- Shared space
- Private space

## An uncomfortable space

*Needed immediate furniture:*

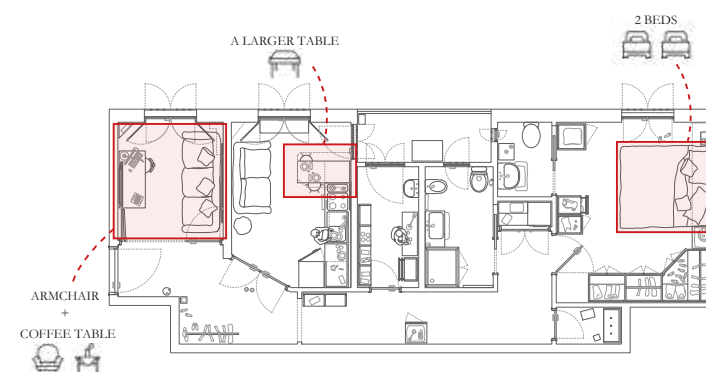

### Issues:

- \_ There's a lack of privacy due to the use of the same bed in the bedroom  
Need: two bedrooms with separated beds (maybe the studio could be used as a bedroom)
- \_ The presence of a huge connection space (projected by the previous owner)  
Need: the space in the house could be use in a better way to have more space for the living room, also to host friends and other people
- \_ Contemporary use of the kitchen in the morning  
Need: a larger table to prepare meals and to eat

### Positive aspects:

- \_ Presence of two bathrooms

# RELIGIOUS COMMUNITY

2

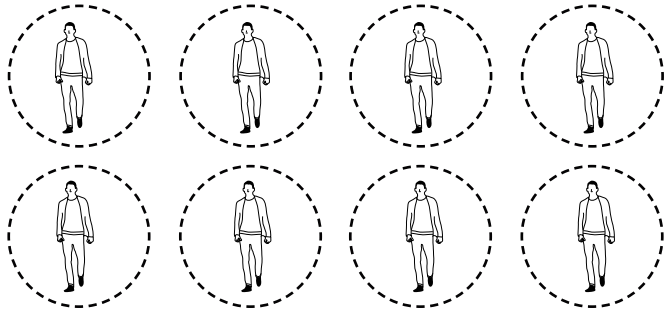

Milan, IT

The eight men decide to live together for their religious duties: they are part of the order of the Memores Domini, a catholic order of consecrated laymen. They are consecrated because they make a profession of faith. They are layman because they can live their vocation through their job and a normal life. In the house they have moments of religious activities that are done in a common room used as a chapter but also dinner and lunch space. Three by three they share the bathrooms, but each of them has his own private space that is the bedroom. The residents are: Giovanni (54 years old) an architect, Paolo (48) a smith, Paolo (68) math teacher in university, Nicola (42) professor of technics in secondary school, Alessandro (51) nuclear doctor, Andrea (48) economist, Massimiliano (38) marketing, Riccardo (44) a construction engineer



8 rooms apartment

200 m<sup>2</sup>



**Bedrooms**  
109 m<sup>2</sup>

- Giovanni 18 m<sup>2</sup>
- Paolo 10 m<sup>2</sup>
- Paolo 14 m<sup>2</sup>
- Nicola 13 m<sup>2</sup>
- Alessandro 12 m<sup>2</sup>
- Andrea 13 m<sup>2</sup>
- Massimiliano 17 m<sup>2</sup>
- Riccardo 12 m<sup>2</sup>



**Bathrooms:**  
18 m<sup>2</sup>

- I Bt: 5 m<sup>2</sup>
- II Bt: 8 m<sup>2</sup>
- I Bt: 5 m<sup>2</sup>



**Living room**  
18 m<sup>2</sup>



**Kitchen**  
10 m<sup>2</sup>

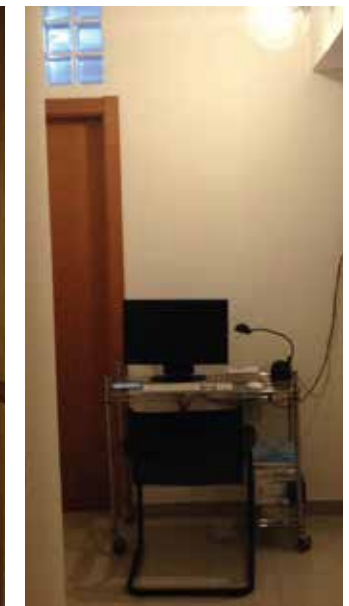

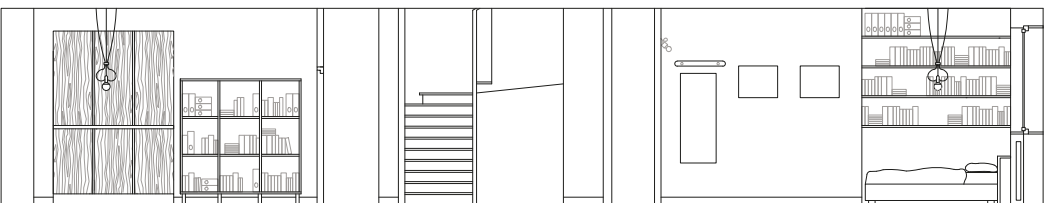
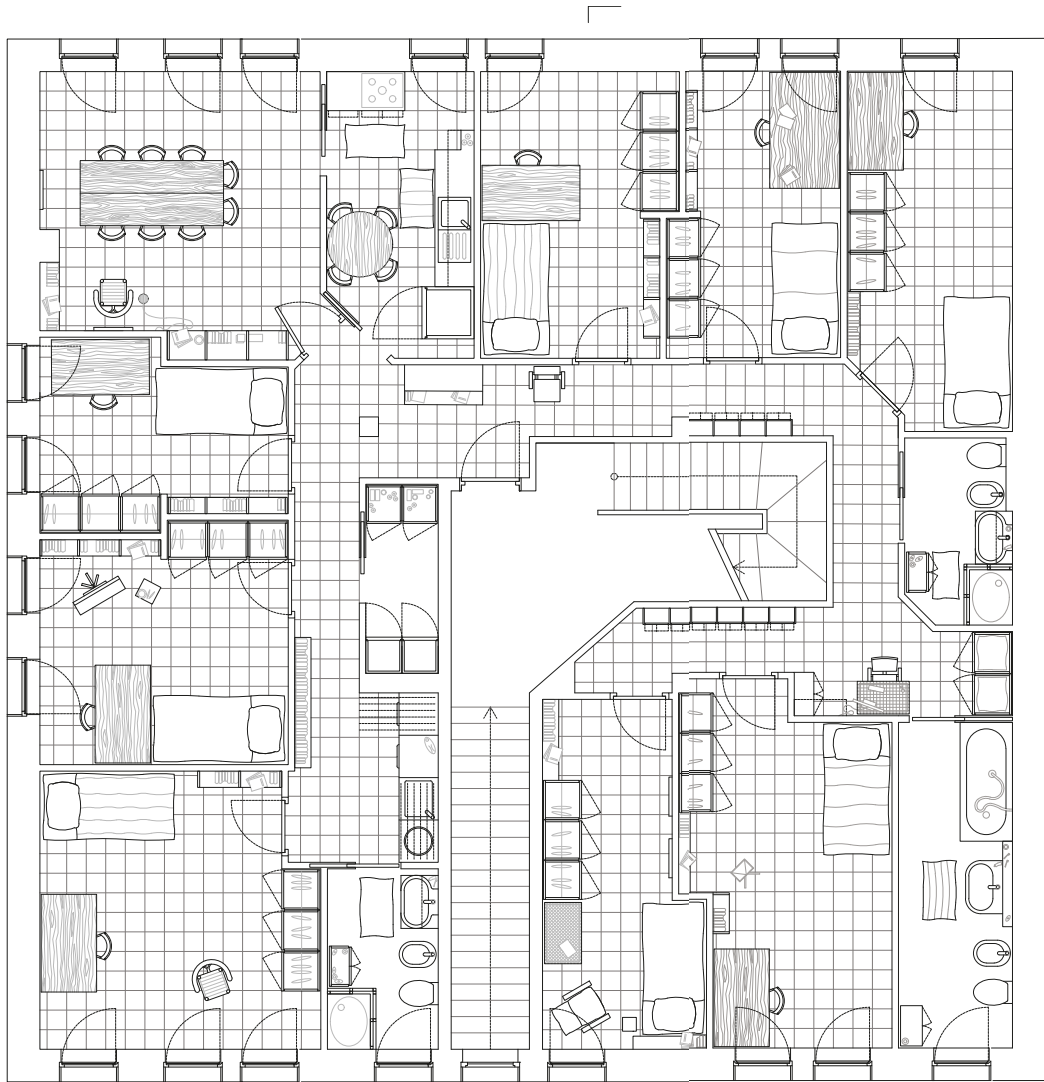

### Privacy levels

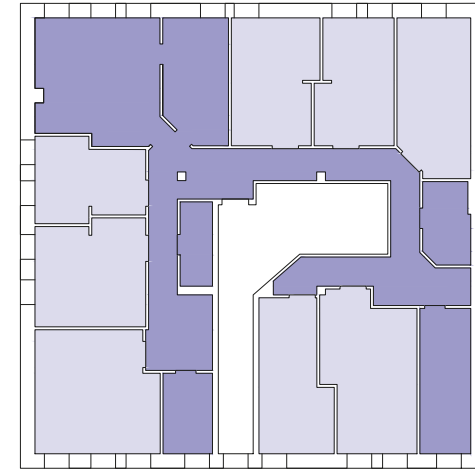

- Lower privacy
- Higher privacy

### Community space

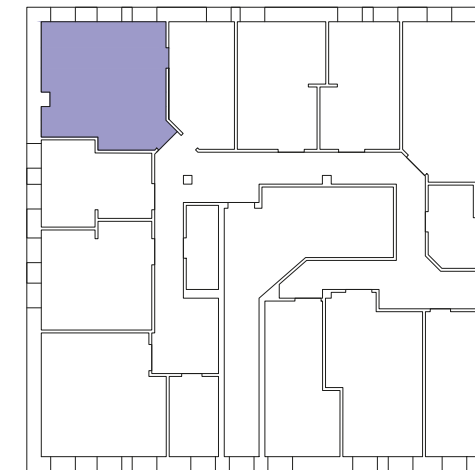

- Space dedicated to the life of the community (18 mq)

Other spaces:  
 Bedrooms: 109 mq  
 Services: 28 mq

# MARTINA, MARTA, FLAVIO & OMAR

Student, Student, Employer, House Owner  
21 years old, 21 years old, 32 years old, 45 years old

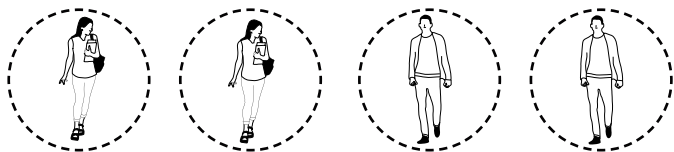

Milan, IT

The house is located in close to Politecnico University area in Milan, the owner is Omar an employee who works in Austria but he finds himself often in Milan for business trip and for check its apartment conditions. For this reason, he still has a personal room inside the house. Flavio is an employed as well in Milan, he have studied economics and he also has a personal room. The girls are sharing a bedroom; they both came to the same university but they studied different things, one architecture and one engineer. They are sharing the bathroom, the kitchen and the living room, fortunately their different habits and time-table helps to make the co habitation easier.



**3 rooms apartment**  
**61,3 m<sup>2</sup>**

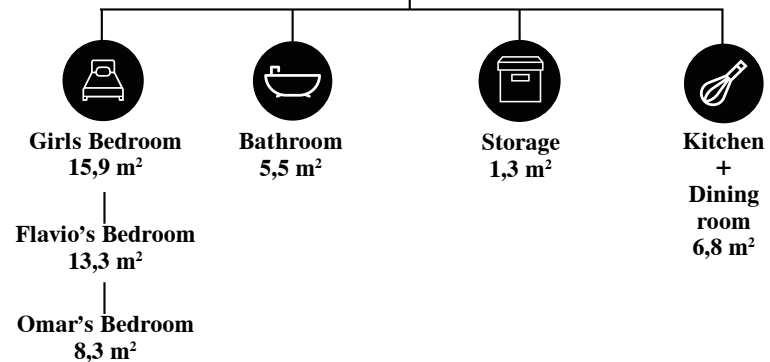

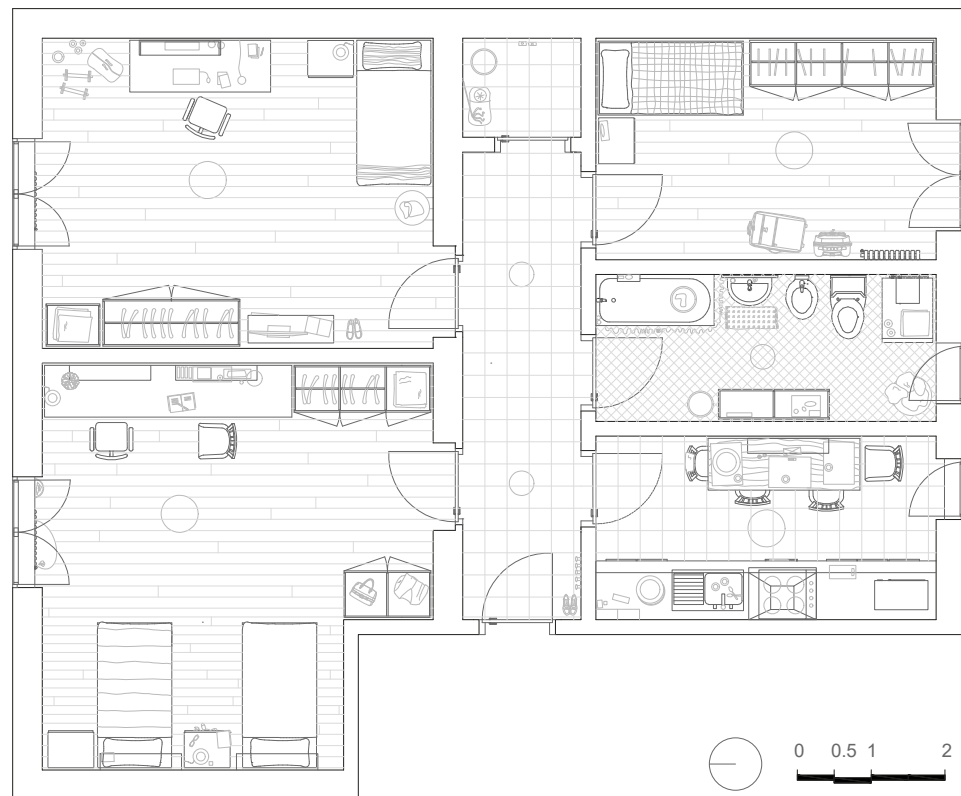
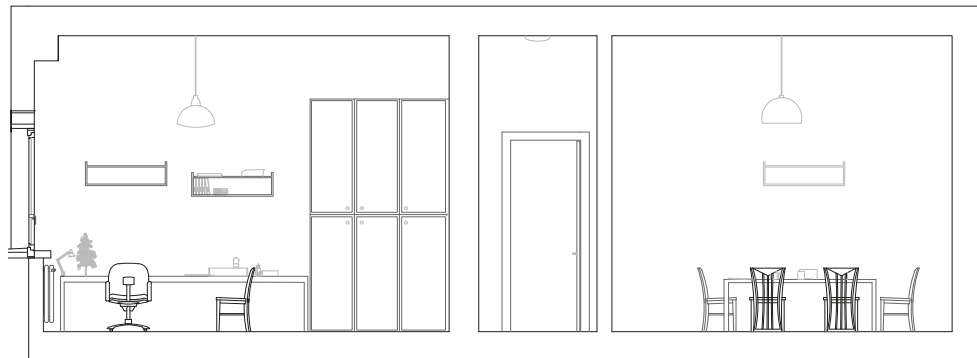

### Privacy levels

- Common Area
- Private parts in the Common Area
- Private Area

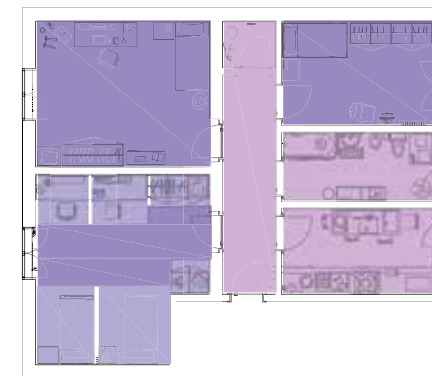

### Usage levels

- Most used Area
- ↓
- Less used Area



# PIERINA & CHIARA

4

Nurse, Make-up Teacher  
54 years old, 29 years old

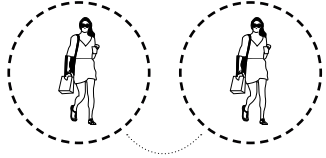

Buccinasco, IT

Pierina and Chiara are mother and daughter: they live together in Buccinasco (MI) since Pierina divorced from her husband. Pierina works as nurse in Polyclinic hospital, while Chiara is a make up teacher in BMC school. Both of them loves clothes, shoes and vintage markets and the house reflect their personality. Pierina does not stay everyweek in the house, because she is often at her patner's place. Consequently Chiara has mostly the entire house for herself, where she is mainly using only the bedroom in winter, while in the summer she uses all the rooms.



3 rooms apartment

100 m<sup>2</sup>



Pierina's  
Bedroom  
13 m<sup>2</sup>

Chiara's  
Bedroom  
6,7 m<sup>2</sup>



Bathroom  
10 m<sup>2</sup>



Terrace  
21 m<sup>2</sup>



Living  
room  
32 m<sup>2</sup>



Kitchen  
15 m<sup>2</sup>



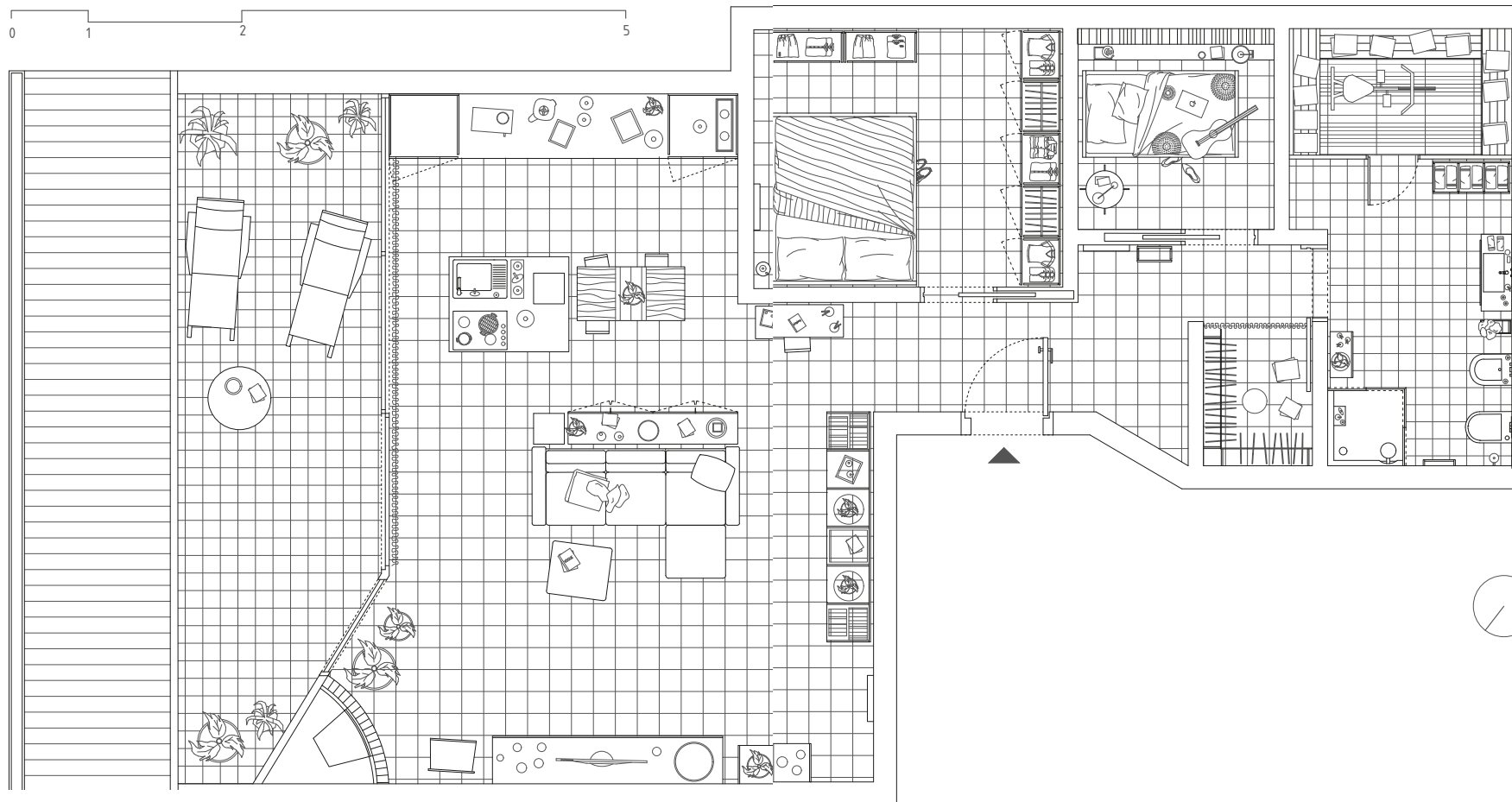
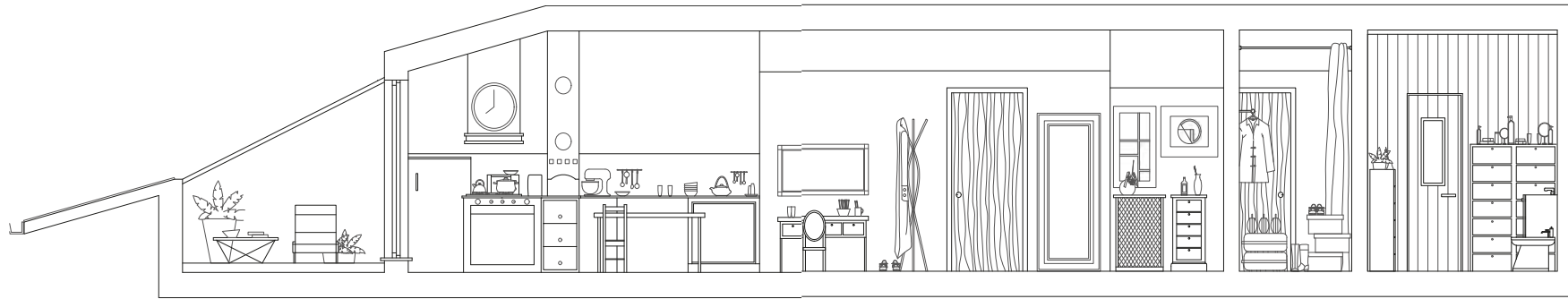

### Privacy levels

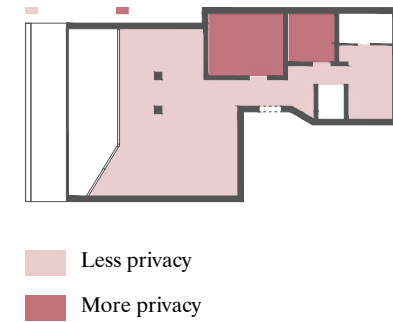

### A house for Chiara

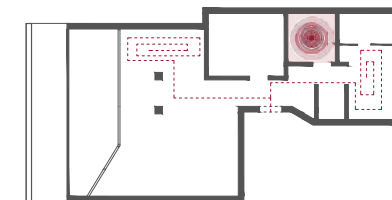

Plan with the space tht Chiara uses when she is alone

# MARISA & GIORGIO

5

Retired, Crane operator  
83 years old, 53 years old

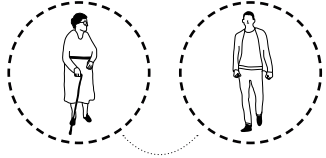

Ravenna, IT

Marisa is the mother of Giorgio, they live together in their life-time apartment, since Giorgio has no family and Marisa got old. Despite her age, Marisa is an active woman with many passions, she spends time outside and when she is inside the house she stays in the kitchen or the living room, where she can cook and invite friends over. She feels confident in her apartment, that now is too big for her, in fact she lives here since the 70's as all the other residents of the building, they grown up together and they can help or take company to each other. Her son Giorgio works as crane operator, he does shift so his schedule is flexible during the week. He does not spend much time at home, during his free time he prefers to meet with friends. They do not share much time together in the house, so there are no conflicts, except that the mom's presence gave to Giorgio less privacy when he needs to host friends.



3 rooms apartment  
124 m<sup>2</sup>

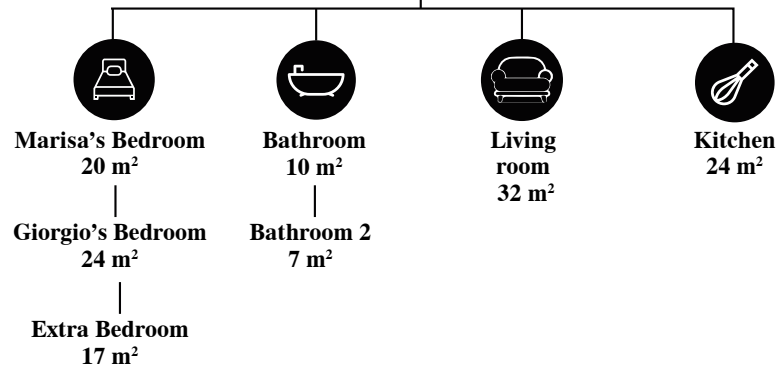



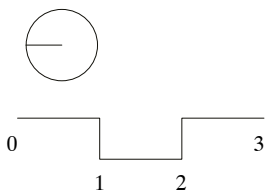
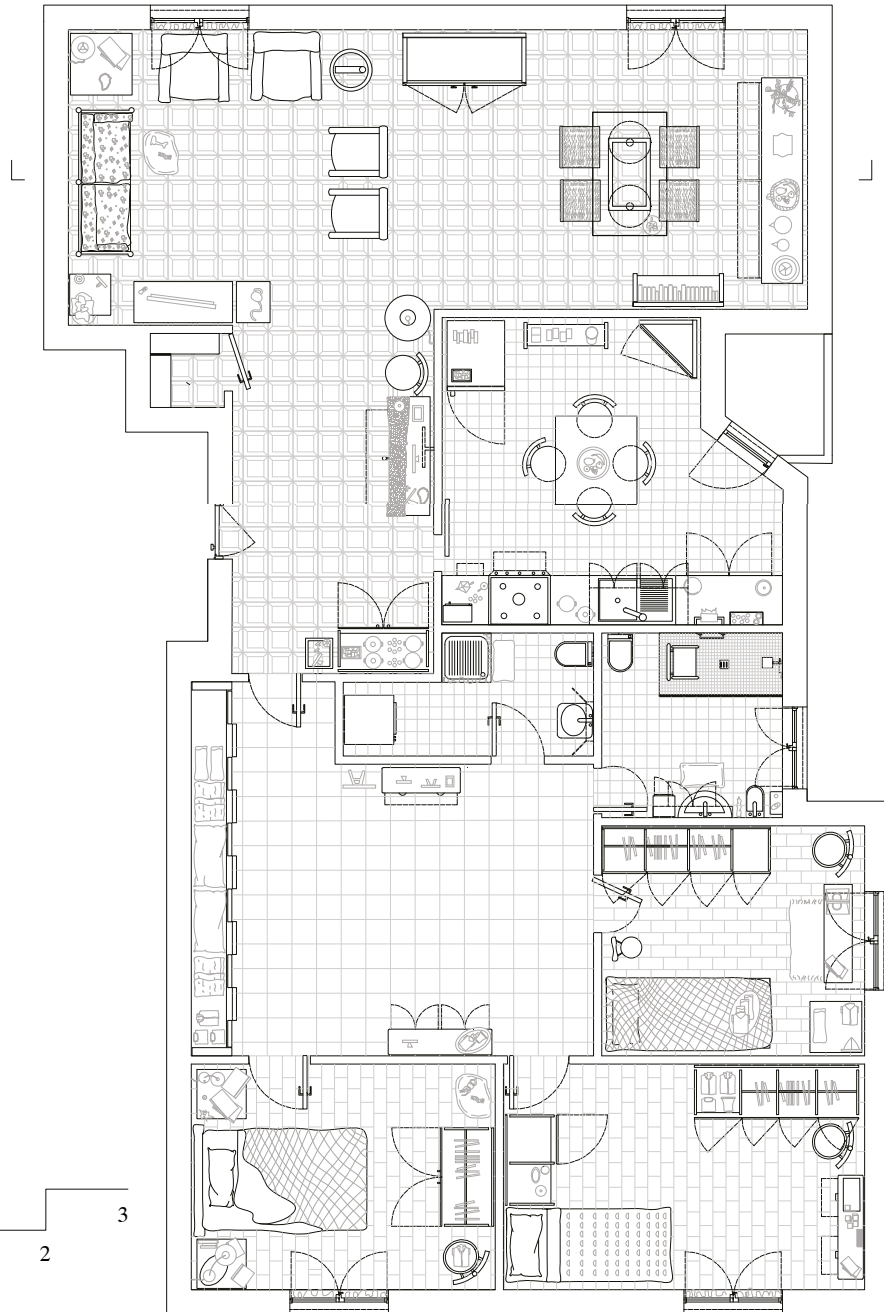
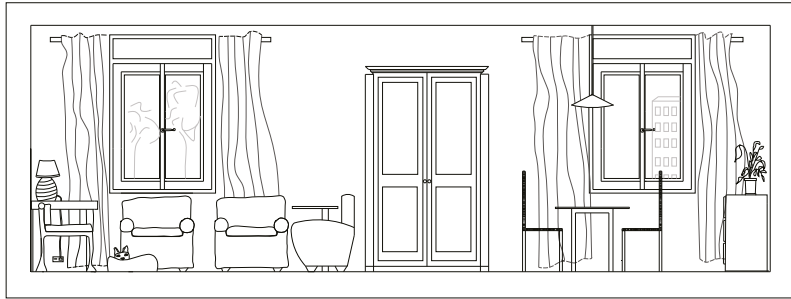

**Privacy levels**

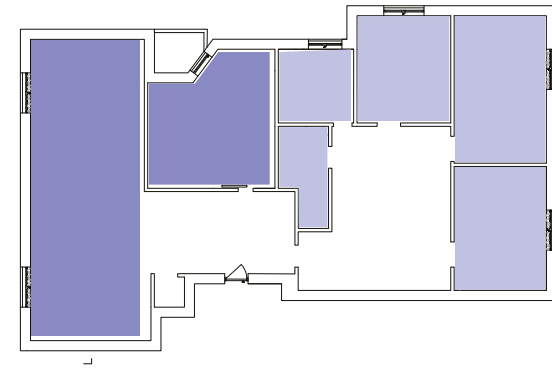

- Less privacy
- More privacy

**Space dedicate to social life**

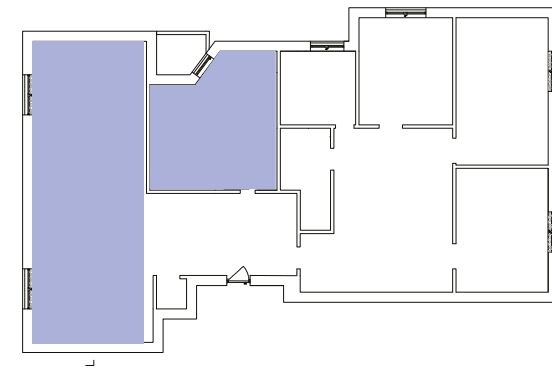

Even if the house is big the space is not independent enough for people with such different lives, this has as a consequence a lack of private and social spaces for Giorgio

- Marisa
- Giorgio

# FRANCA & BRUNELLA

6

Retired, Worker  
77 byears old, 70 years old

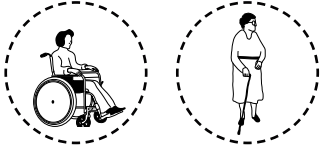

Langhirano (PR), IT

Franca and Brunella are sister in law: Franca was the wife of Brunella's brother, who passed away in 2001. They are living together alone from 13 years; Brunella is still an active woman, she is working part-time as secretary and then the rest of the time she dedicate herself to take care of Franca. After undergoing a stroke, Franca remain paralysed for half of her body, consequently she is not able to have a normal life without an external help, that's why the two women are depending one another. Brunella is spending a lot of time outside home and inside the house she is using almost all the room, on the other way Franca stays mainly in her bedroom. Occasionally they are receiving Franca's sons and nephew for lunch or dinner, in this case they are spending a lot of time around the living room.



5 rooms apartment  
128,8 m<sup>2</sup>



Brunella's  
Bedroom  
8,67 m<sup>2</sup>

Franca's  
Bedroom  
12,9 m<sup>2</sup>



Studio  
6,7 m<sup>2</sup>



Bathroom 1  
4,9 m<sup>2</sup>

Bathroom 2  
5 m<sup>2</sup>



Terrace  
50,4 m<sup>2</sup>



Living  
room  
23,9 m<sup>2</sup>



Kitchen  
10,3 m<sup>2</sup>

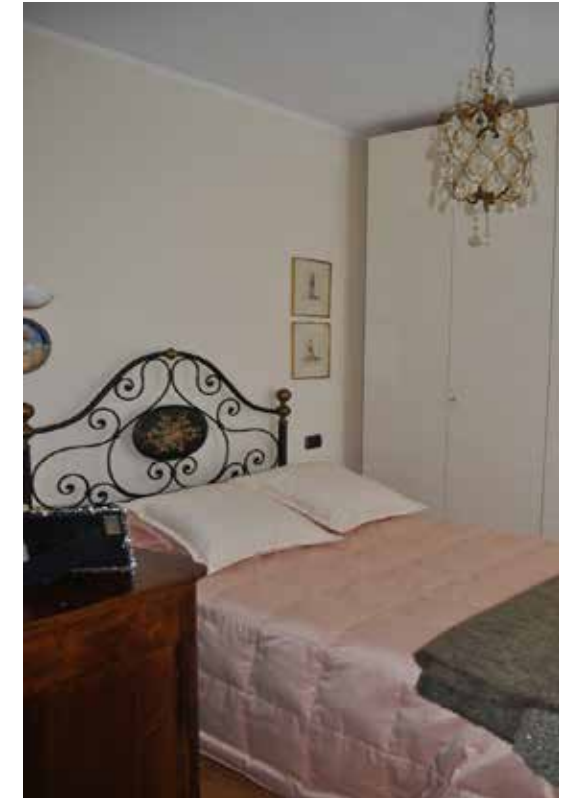

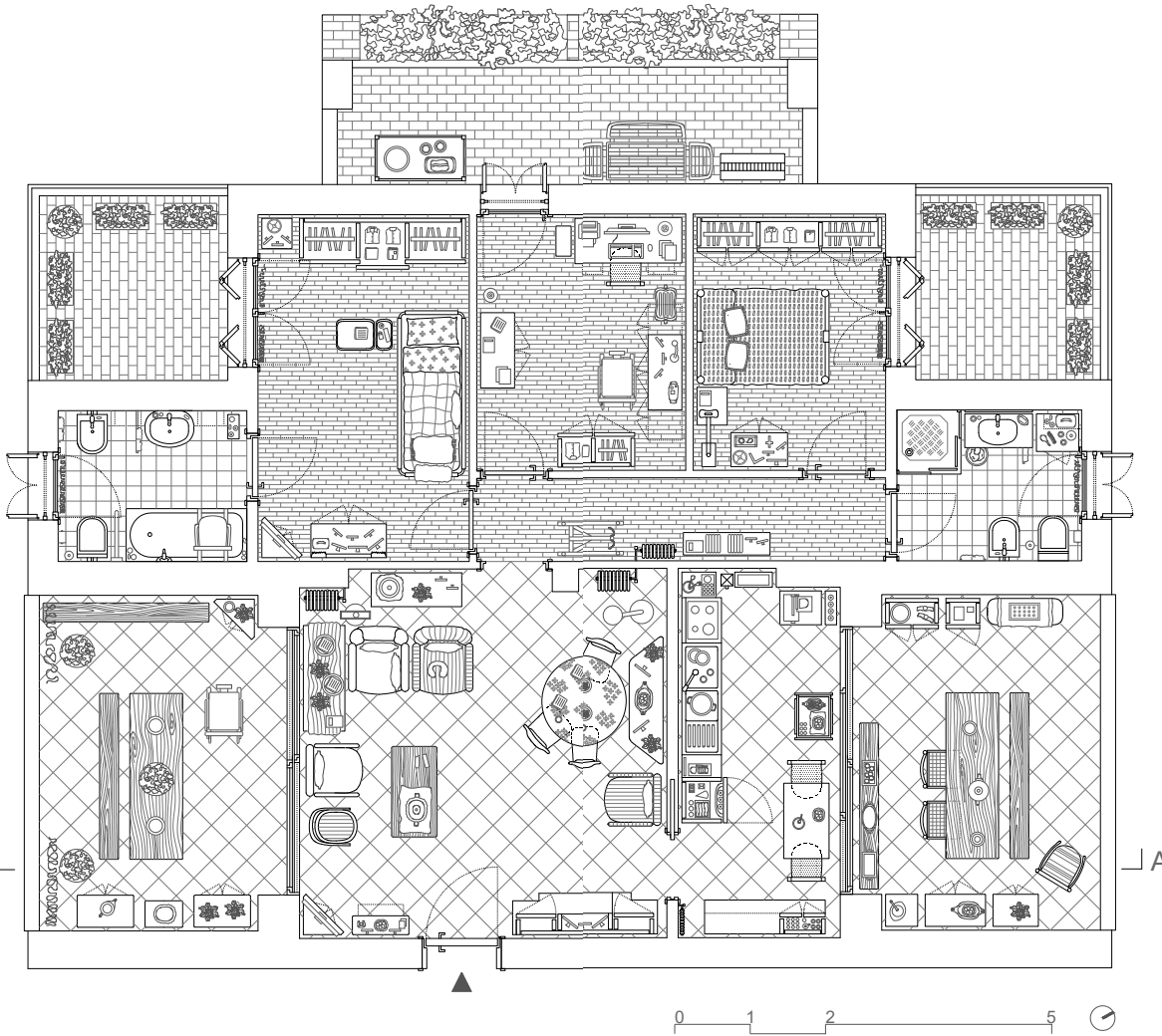
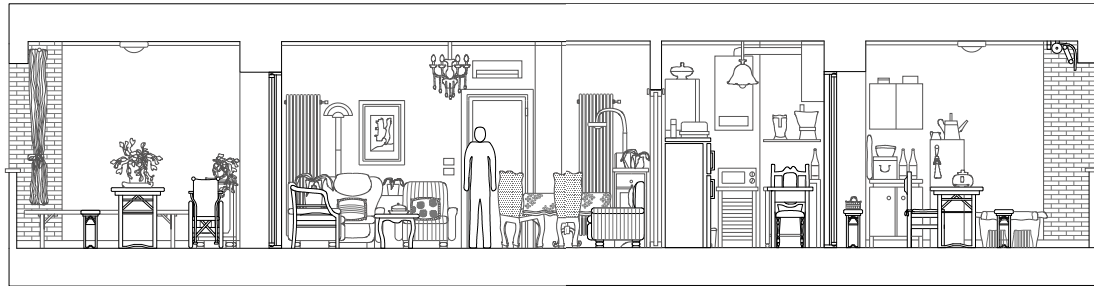

### Privacy levels



### An uncomfortable space

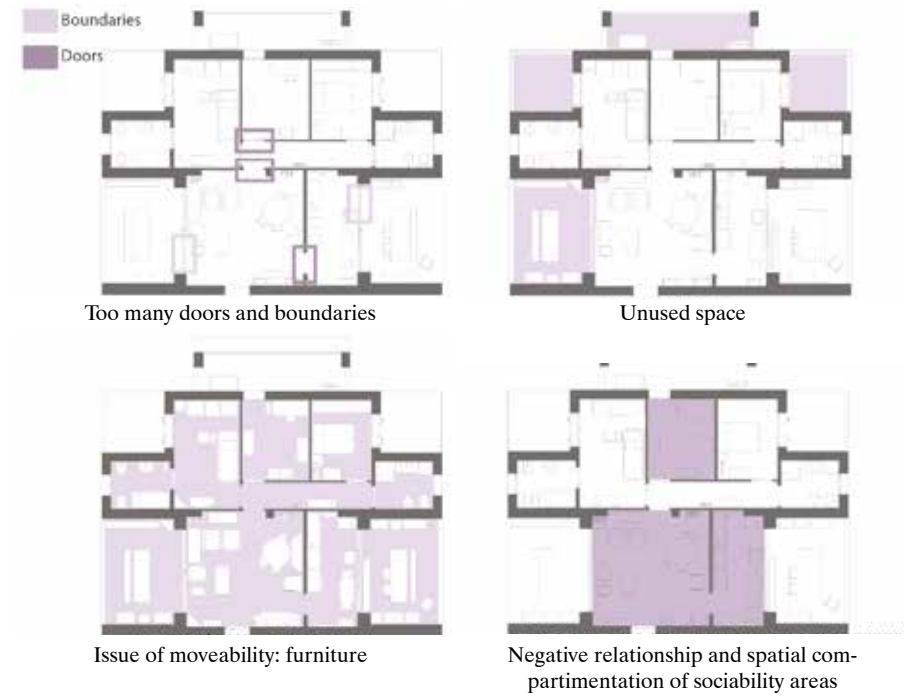

# TYPE D

COUPLE + ADULT(S)

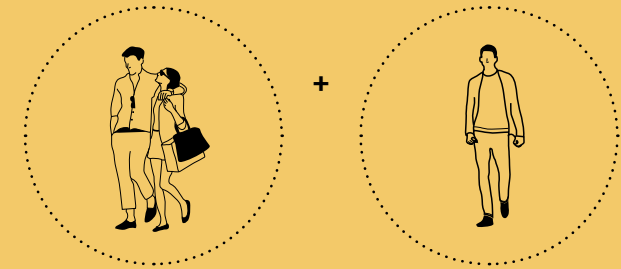

The category contains a couple without children that host another person in their households, in most of the case the adoption of an extra person in the house hold is a temporary solution. We may find grandparents who host their little nephew or a caregiver, but also couples who host a friend of a family member. The privacy is generally keep, except in case of a child presence which change the layout and order inside the house. In the other case the presence of an adult can be solved given them a personal room. The solution is generally temporary, when the adult will be able to find an accommodation for himself or find a convenient solution of living the co habitation can be over.

# YOVAN, ARIANA & STEFANIA

Bank Consultant, Baby Sitter, Teacher  
29 years old, 28 years old, 25 years old

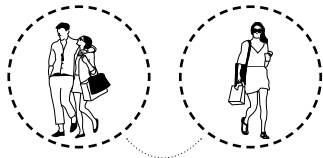

New York, USA

Yovan got married with Ariana in 2015; he studied political science and now he works as a private client consultant in a bank in New York; Ariana studied as well the same faculty of her husband but she is now working as baby sitter. From two years Ariana's sister Stefania moves with the couple, she is an elementary teacher. The three of them have a good relationship in the house; Stefania and Yovan have to share the house in the morning, while for the rest of the day their routine are different. They spend a lot of time together in the living room and when need it, Yovan and Stefania use the dining room for work. During the weekend Stefania's boyfriend comes to visit her, in this case the four of them are so spending a lot of time outside the house.



5 rooms apartment  
161 m<sup>2</sup>

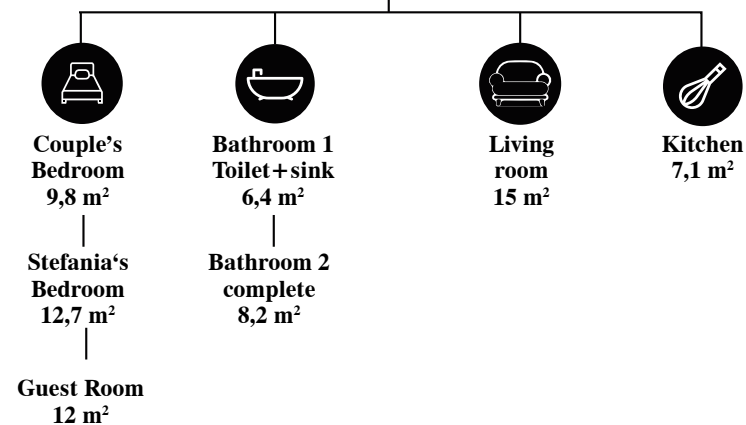

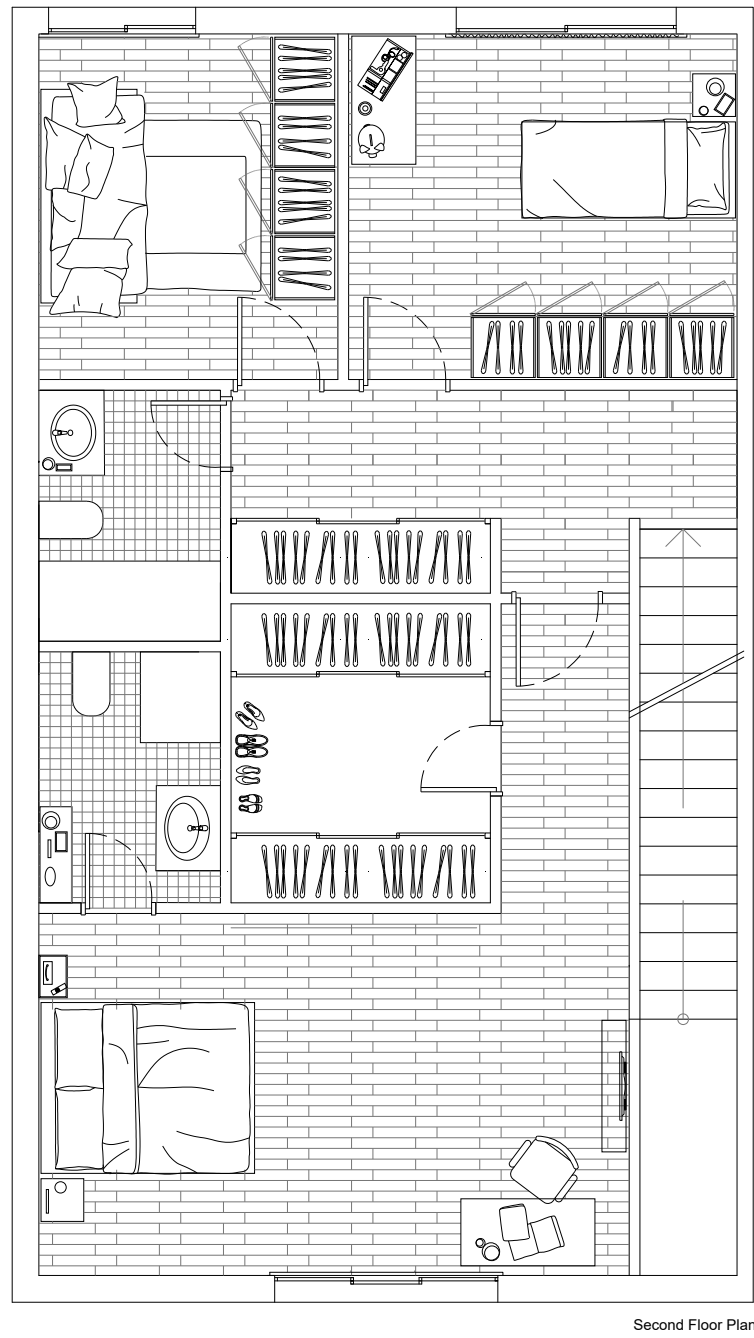
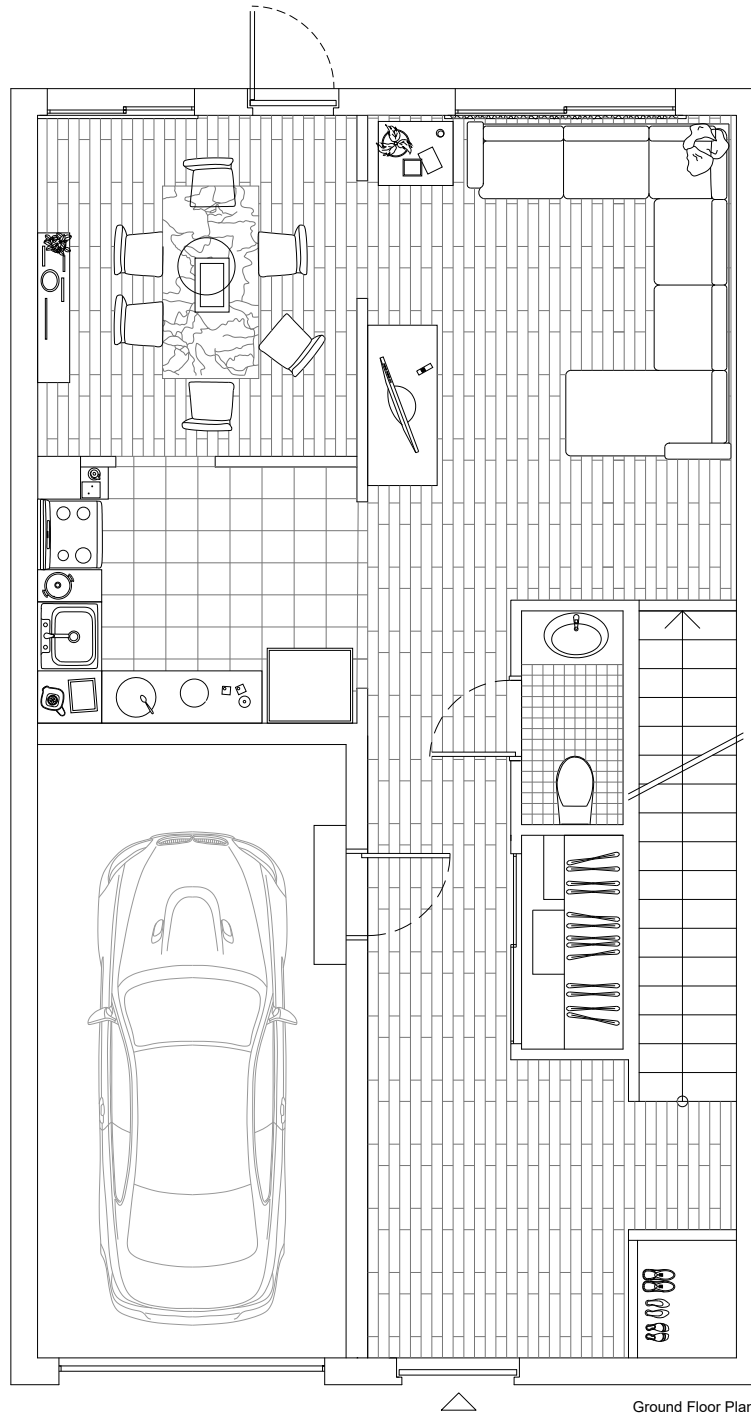

### Privacy levels

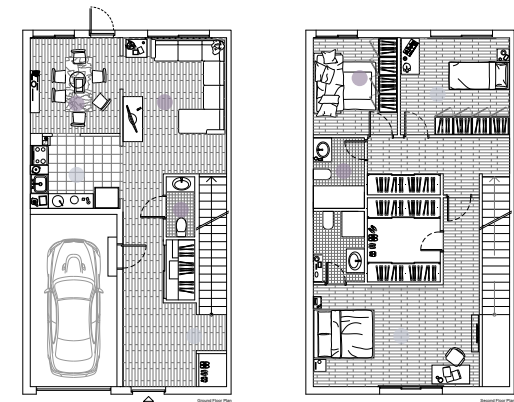

- Less privacy
- More privacy

### An uncomfortable space

#### ADULTHOOD WITH YOUR SISTER

main issues:

- "Big Deal": Ariana is not a morning person, Stefania is a bright one. Stefania would take Ariana's speechless mornings in a personal way. Steffie is a very emotional person.
- Personal Time: Ariana is a moody person, and sometimes needed some "alone" time, Stefania doesn't need alone-time and would not understand her sister, therefore, would take it as a personal issue.
- Cleaning: Ariana would have to "remind" her sister to clean when it was her turn. Reminding an adult to do things is always an issue.
- Sharing Food: Stefania would frequently forget it was her turn to buy more food.



# GIUSEPPE, DINA & CRISTINA

Pensionier, pensonier, pensonier  
90 years old, 85 years old, 50 years old



2

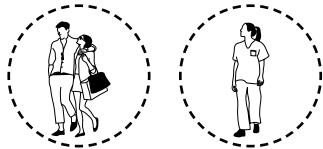

Treviglio (BG), IT

Dina and Giuseppe are husband and wife, they have three sons. They had a really active life, but now that they got old, they like to spend more time in the house: Dina spends a lot of time cooking or both of them like to receive friends and family in the living room. Because of their age and an accident of Giuseppe, they decide to hire a caregiver, who will be change every six months. Now they are hosting Cristina, a polish woman that worked in a bank in Poland. She speaks good Italian , she works all days of the week except during the weekend, where she spends some time with other polish friends. She helps them with house manners, she takes company and she helps Giuseppe to walk and does his exercises. They have a harmony life all together, the only problematic of the house that they found is that there are not furniture for disable that can help the couple to walk in house safely.



5 rooms apartment  
87,4 m<sup>2</sup>

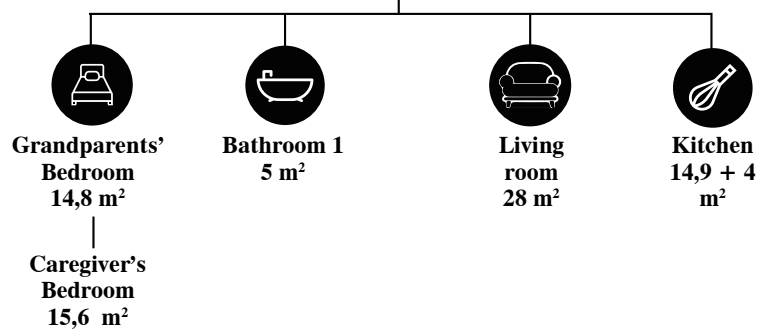

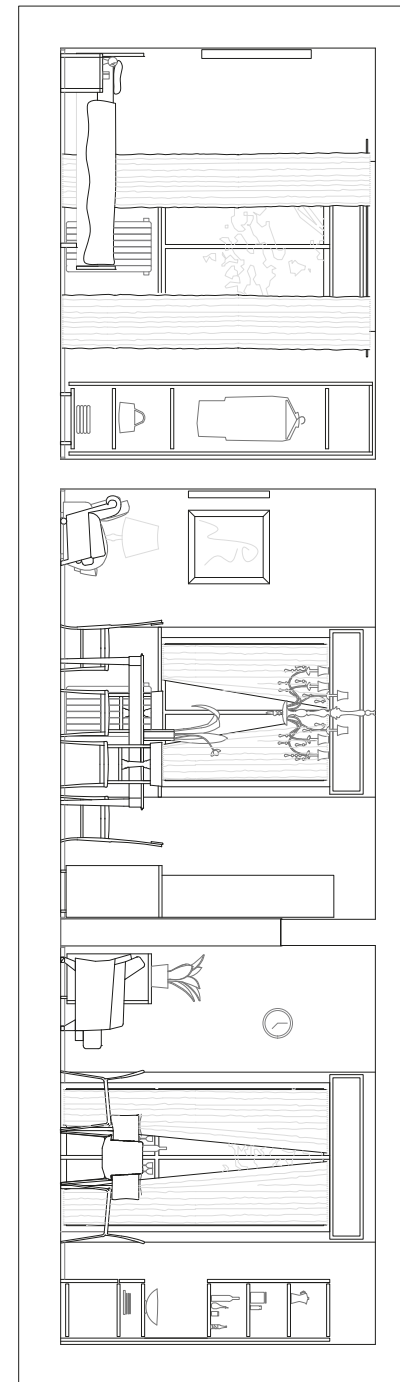
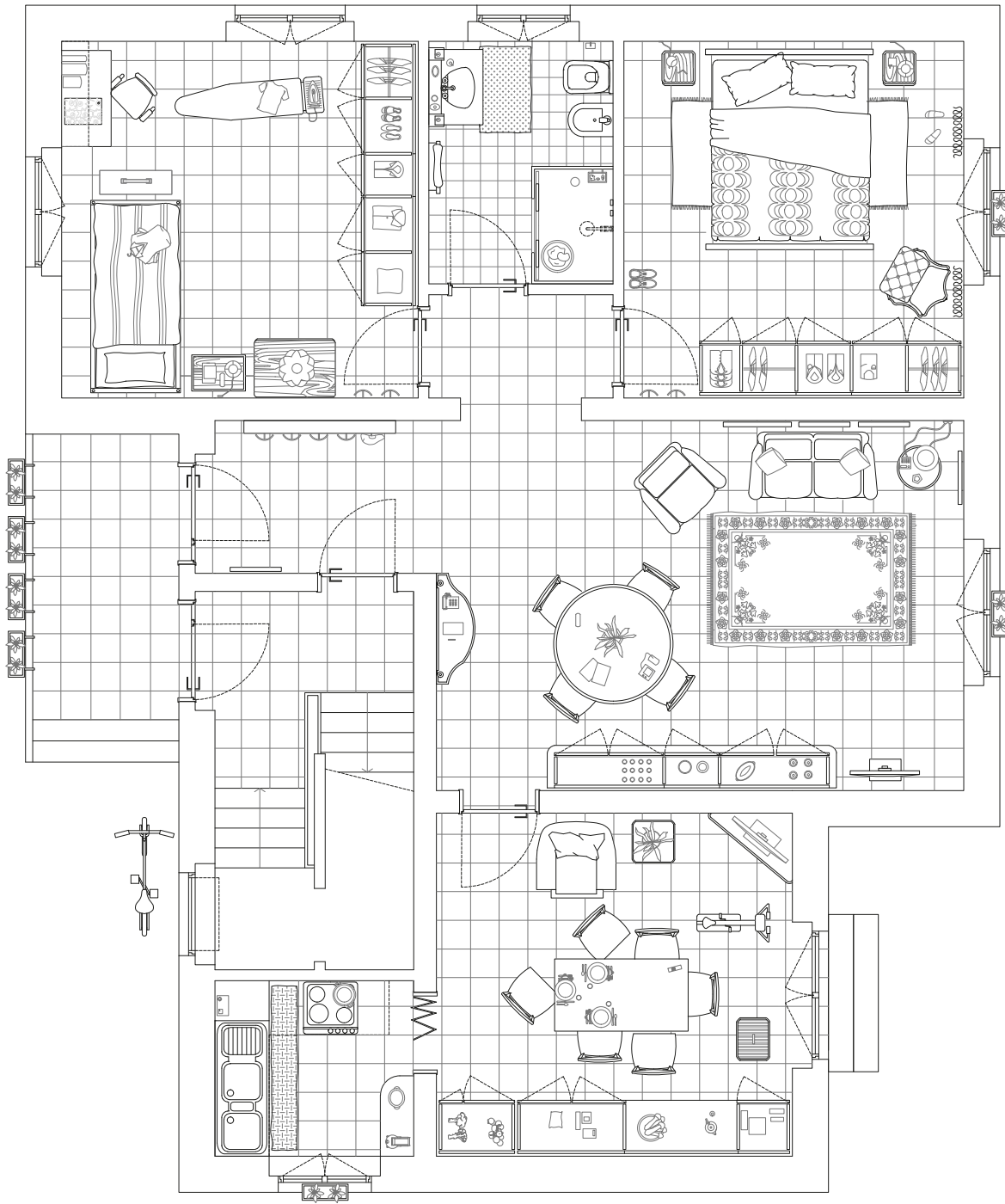

### Privacy levels

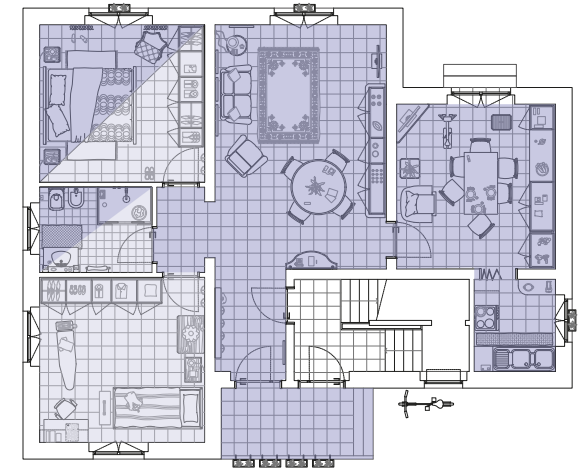

Less privacy      More privacy

### An uncomfortable space

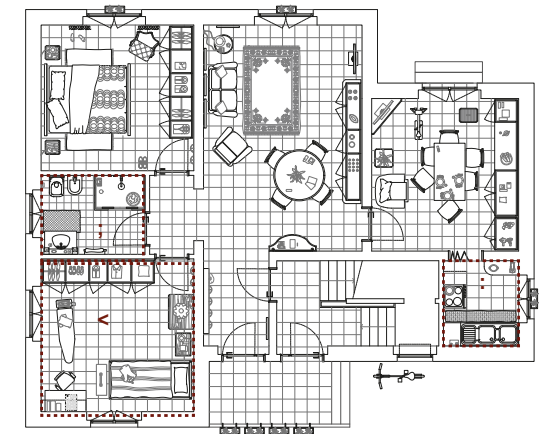

1. Kitchen: the contemporary use by two people or more is complicated; furthermore when my grandfather with his walker goes to kitchen, he has difficult to move in the space
2. Bathroom: the presence of only a bathroom could generate a conflicts
3. Caregiver's bedroom: during her free time she cannot host her friends, because she has not a adapte space, To sove this problem you could put a sofa in his room and have a folding bed.



# GIORGIO, LORETTA & NOAH

Painter, House-wife, -  
64 years old, 63 years old, 2 years old

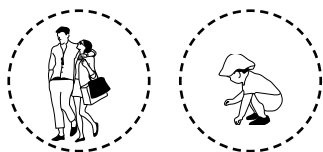

Cantù (CO), IT

Giorgio and Loretta decide to host their nephew Noah, since his parents are working in another city far from their original house. Giorgio is a painter, he works hard for the entire day, he goes out in the early morning and he comes back for dinner; Loretta is retired and she spends the day look after the house and the nephew. Noah is really happy to live with their grandparents, he goes to school in the morning and during the rest of the day he plays in the bedroom and the living room. The grandparents fix the house in a way that Noah can find place to play and to not get hurt with objects or furniture. During the weekend Noah's parents come to pick him up and if it is not too late they go back to their house for the night; otherwise they need to stay in Giorgio and Loretta house and sleep in the same bed with their son.



**5 rooms apartment**  
**70m<sup>2</sup>**

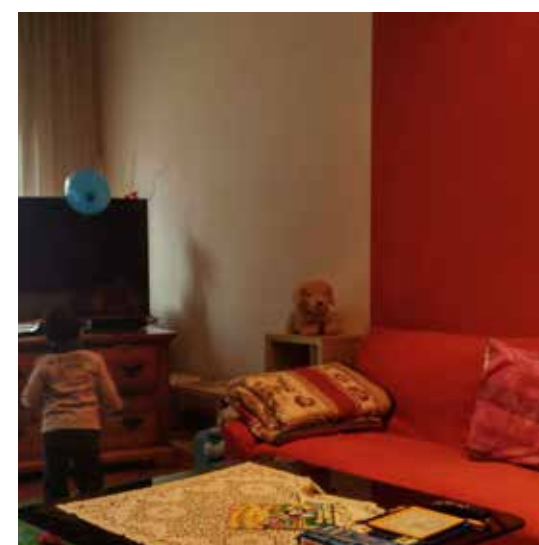
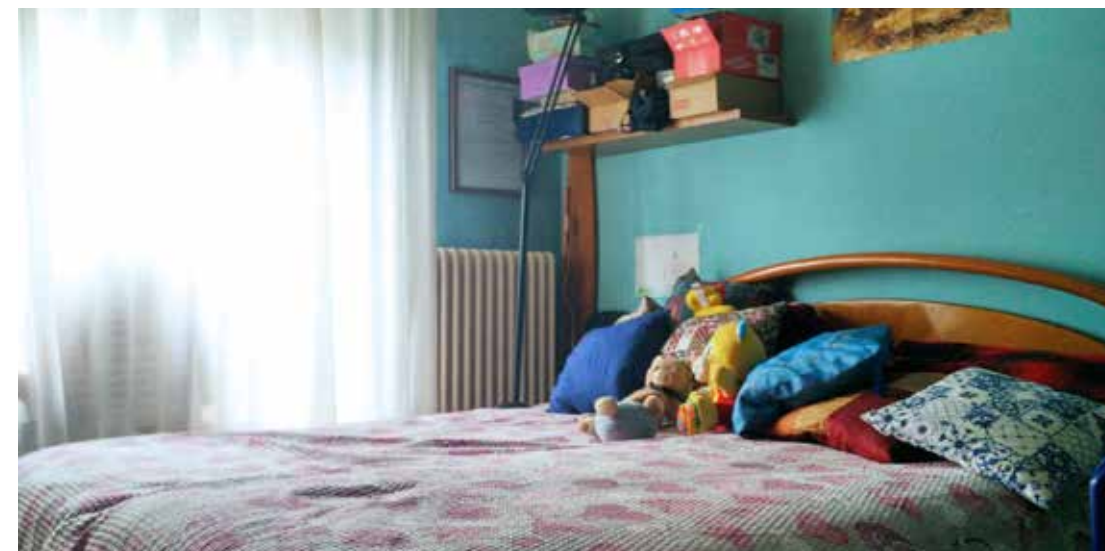
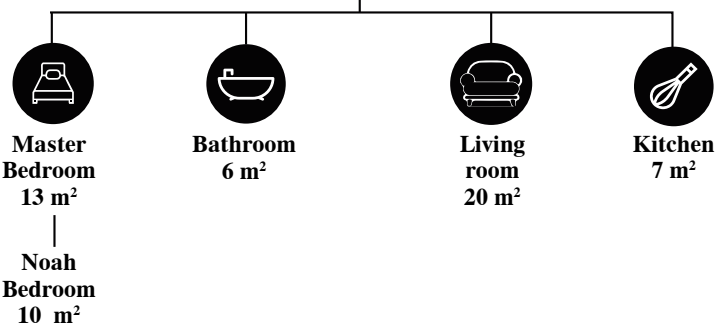

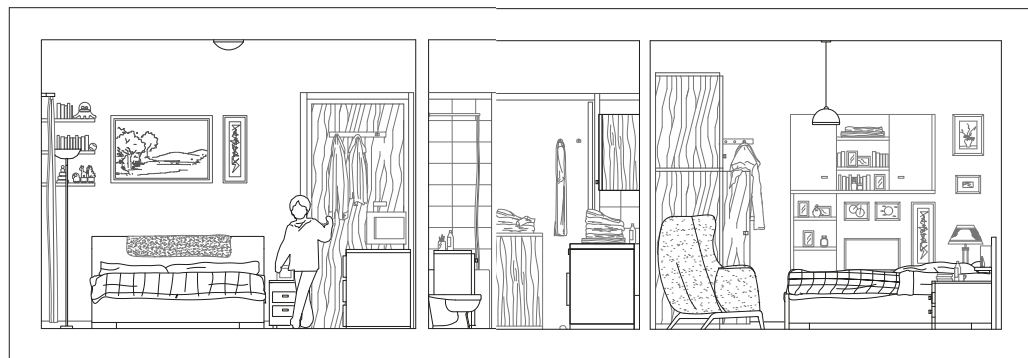
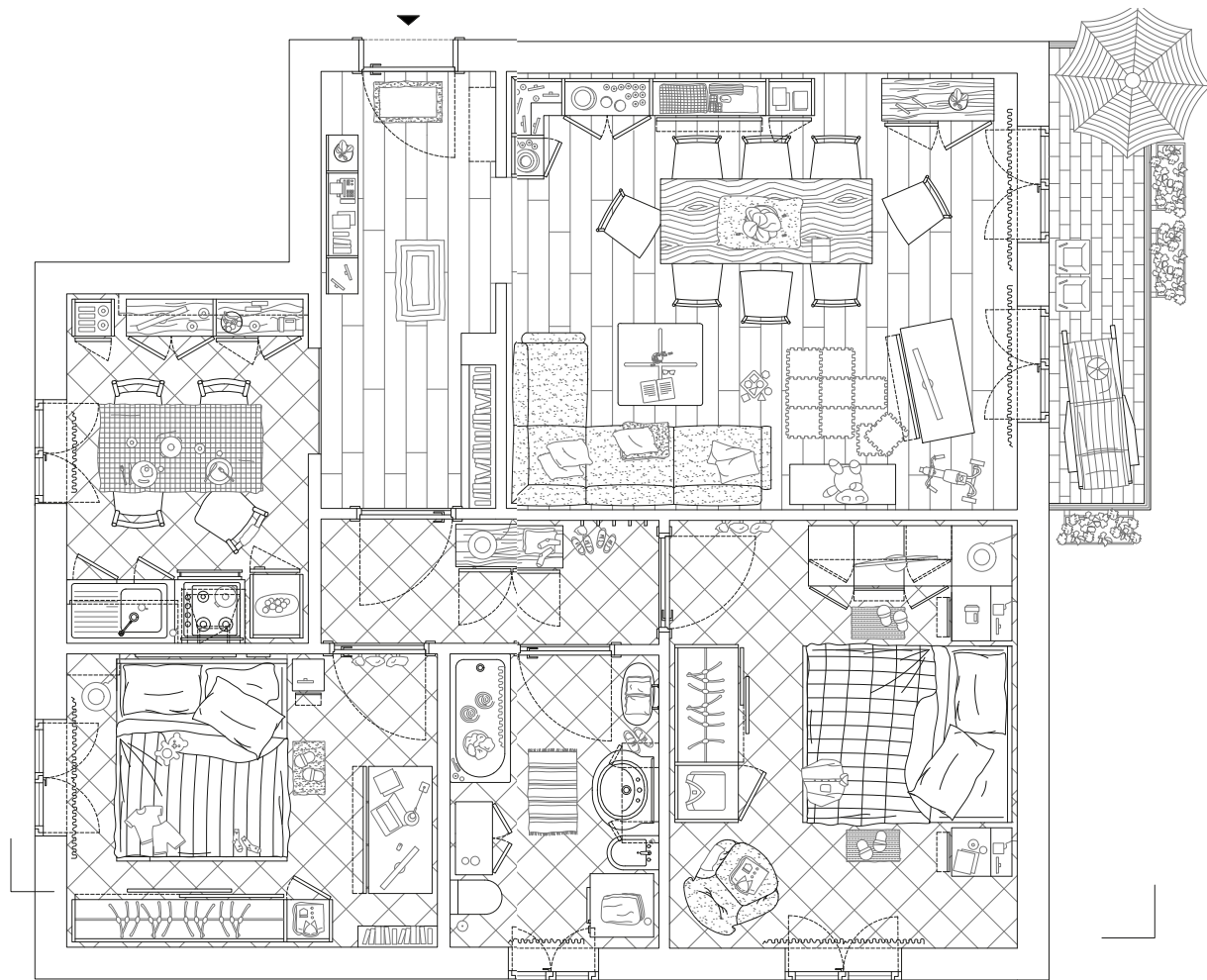

### Privacy levels



### An uncomfortable space: Noah's spots



- Safe zones
- Dangerous zones
- Neutral zones

The most important criticality in this house is related to the situation in in which Radames and Silvana are. As a matter of fact if they are forced to sleep in Loretta's home, they have to do in the same room and in the same bed as Noah since they're is no extra rooms. Even if it's a temporary situation due to their job it's a problem for now.

# KAROLINE, STIAN & MATS

Hairdresser, Student, Kindergarten  
23 years old, 22 years old, 24 years old

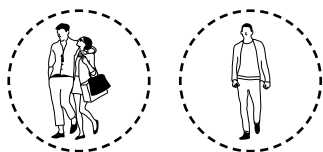

Oslo, Norway

The trio is living together from a couple of years, Stian and Mats know each other from the part-time work and Karoline, Stian's girlfriend, join them lately. They have totally different works and schedule and then their cohabitation is not so complicated. Mats is the one who wakes up earlier since he works in a kindergarten; he is followed by Karoline who works as hairdresser, make-up artist and personal shop in one of the most famous salons in Oslo. Stian on the other way is a student and he has only three hours of lecture por day. The space is small but they can find their privacy and not interfering with each other activities. The only problem is given by the kitchen, which position and dimensions are giving problem to the trio.



**3 rooms apartment**  
**61,7 m<sup>2</sup>**

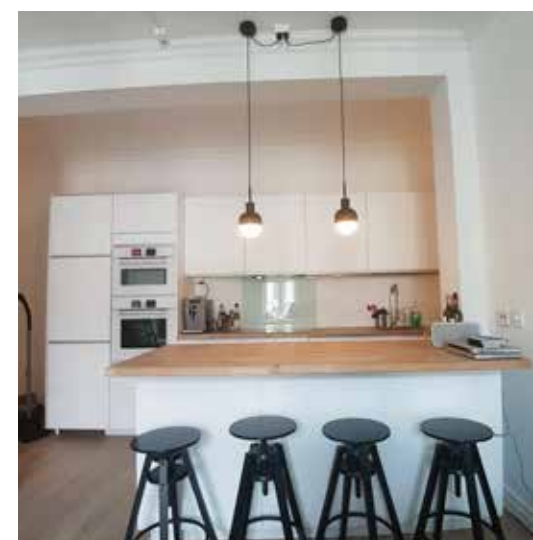
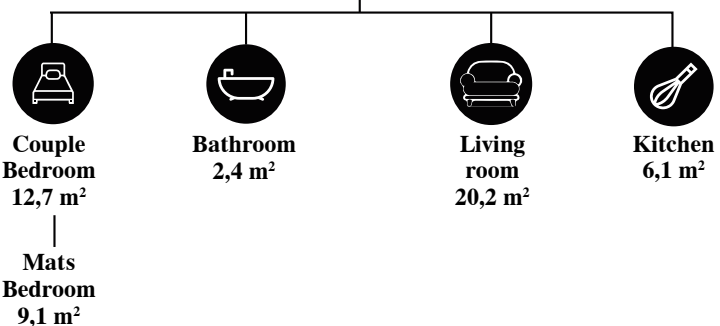

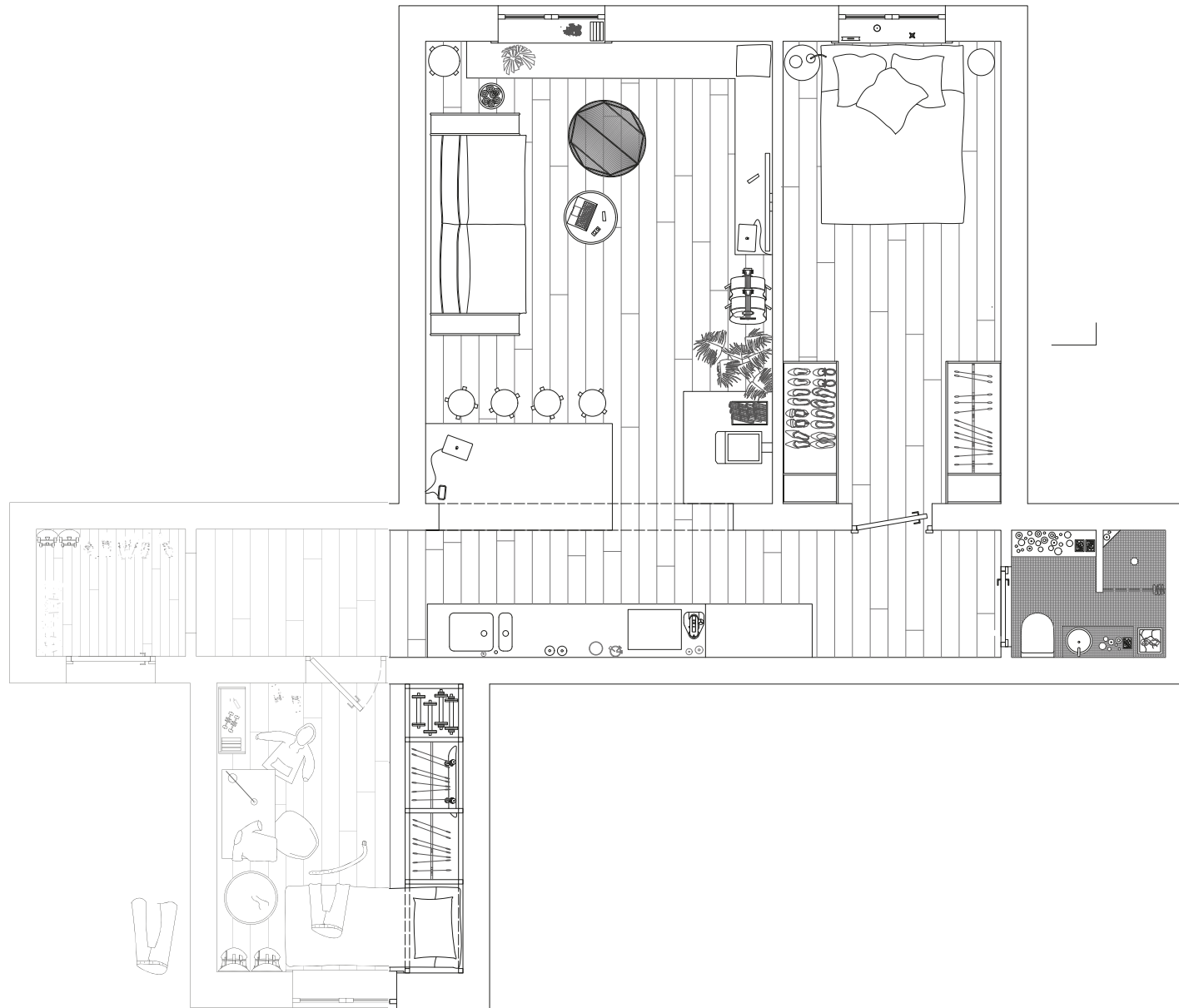

Scale 1:50

### Privacy levels

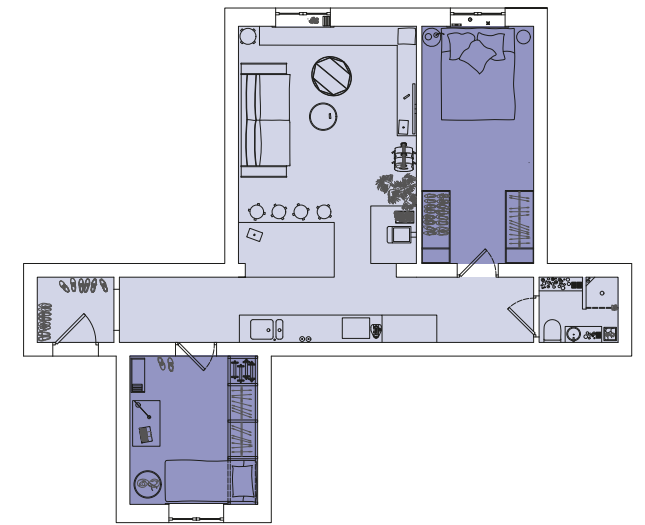

Less privacy      More privacy

### Circulation and kitchen

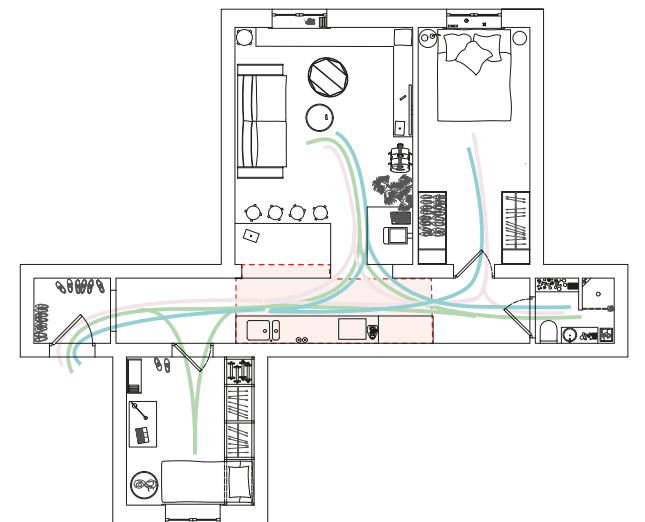

Stian  
Mats  
Karoline

# TYPE E

FAMILY + ADULT(S)

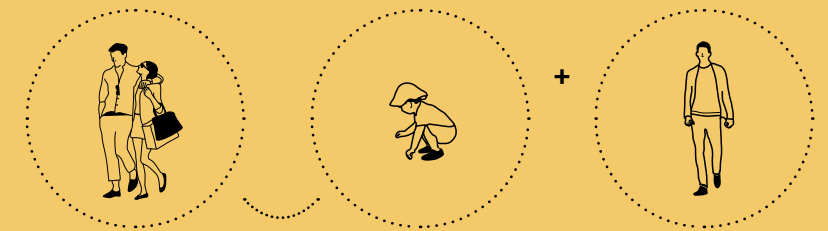

This typology is composed by families who are hosting single adults. In this case we can have multiple and different situations: a family who is hosting young workers, students or elderly. The adults may be blood related or not, in this case the person can be a friend or a strangers who is host in the house for a specific period and for a specific reason. He may teach to children english, he may work in the family as baby sitter or he can be someone that pay a specific rent, hosted for increase the monthly income of the family. The adult can be also a student, in exchange with some programme related to another children of the family, or a student that requires a room to stay. The family who are hosting these people can be composed by a married or not couple with children, or a single parents with children.

# AMBROGIA, INNOCENTE, ANTONIA & NATALIA

Retired, Retired, Retired, Employee  
86 years old, 76 years old, 66 years old, 44 years



The family is composed by four people: Antonia and Innocente that are husband and wife, their daughter Natalia and Innocente's sister Ambrogia. The four of them live in a house since Natalia was born; the house is composed by two floors and Ambrogia has her own apartment on the ground floor, where she lived with her brother Piero until his death. The family is used to eat together at Ambrogia's. Ambrogia is the oldest and she is spending a lot of time at her place, where she can relax and receive visit from friends. Innocente is now retired but he had been worked as smith in the family shed for many years, the shed was located in the same area of the house. Antonia was an ex teacher and now that she is retired she is spending a lot of time at home or Sara's, her second daughter. Natalia is still living in the parents' house and she is still sleeping in her first bedroom, she spends the most of the time at work.

\*Pictures of the house were not provided\*



3 floors house  
400 m<sup>2</sup>

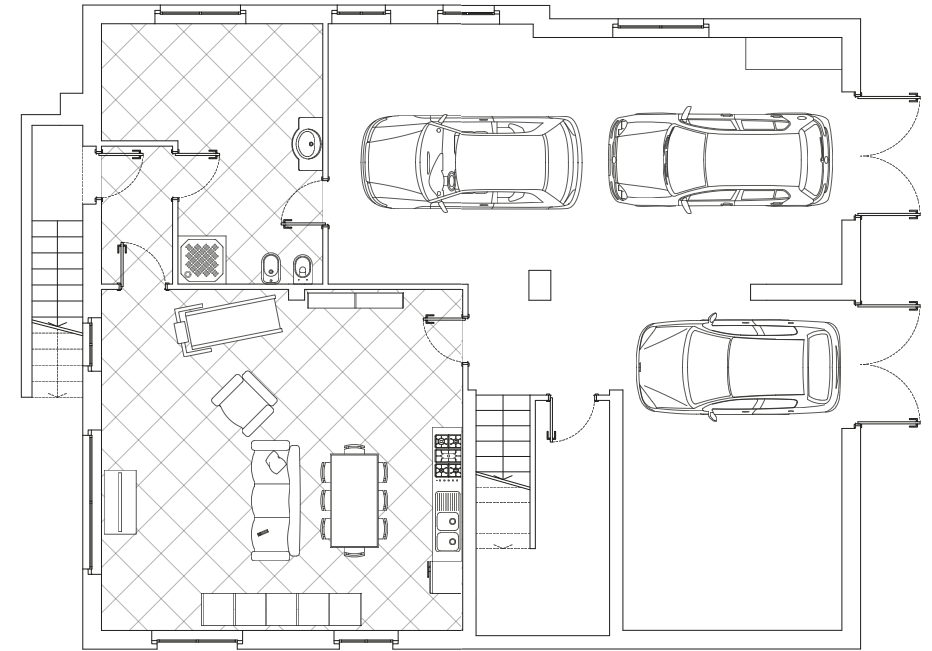
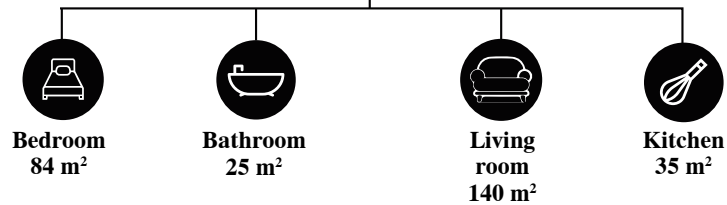

Underground Floor

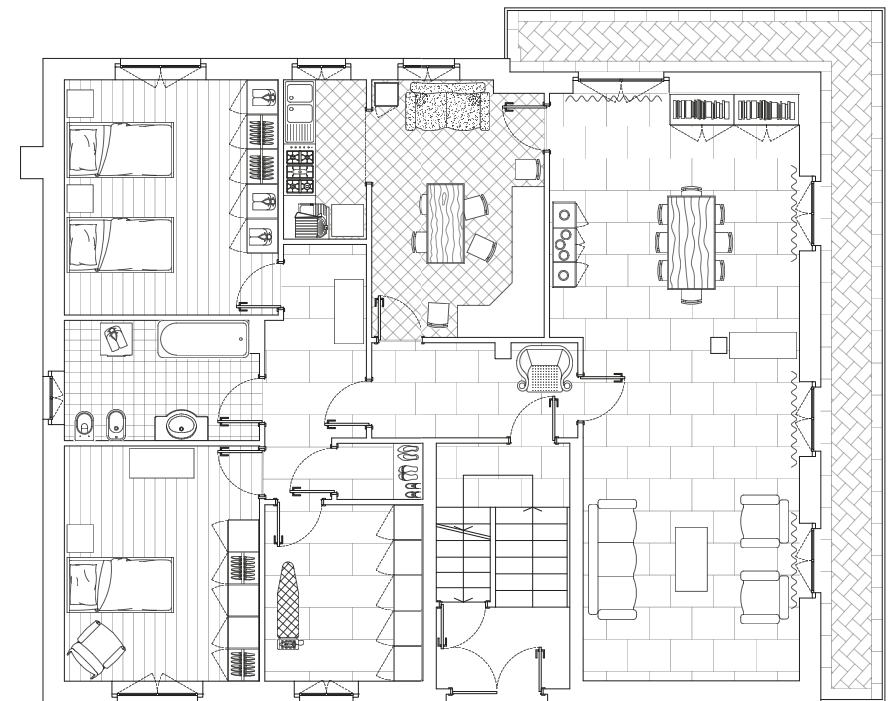

Ground Floor

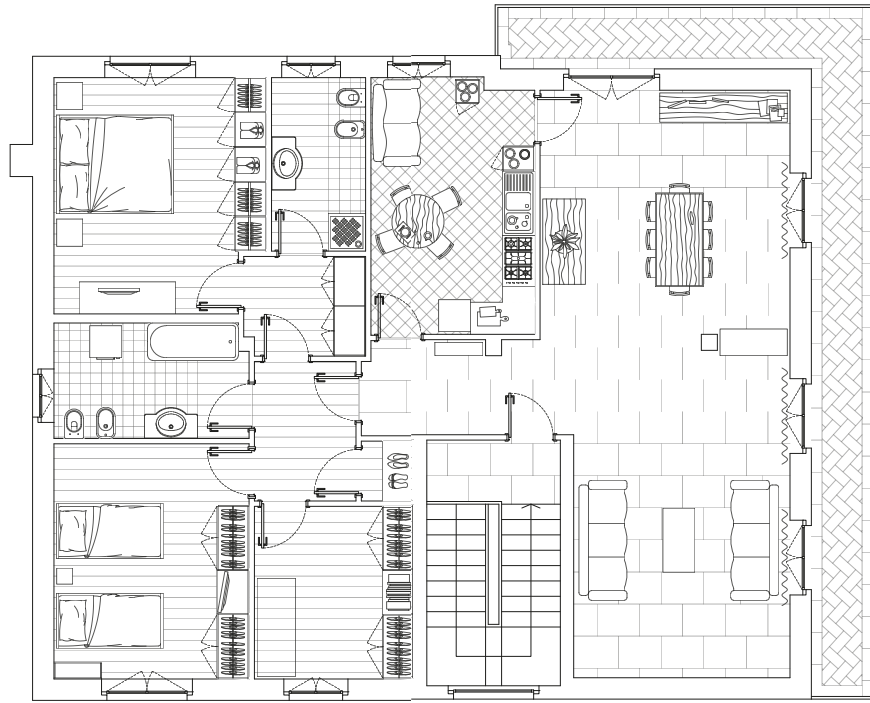

First Floor

Scale 1:100

### Privacy levels

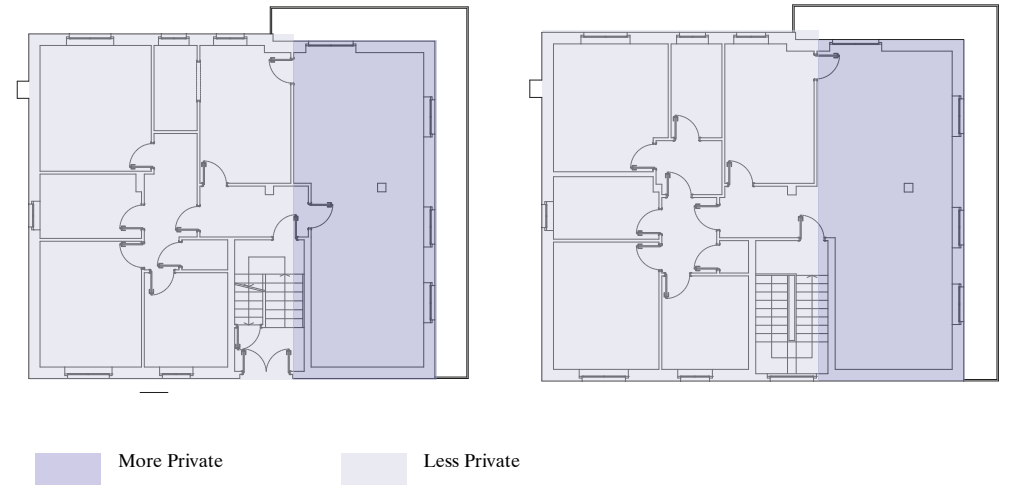

### Usage of the space

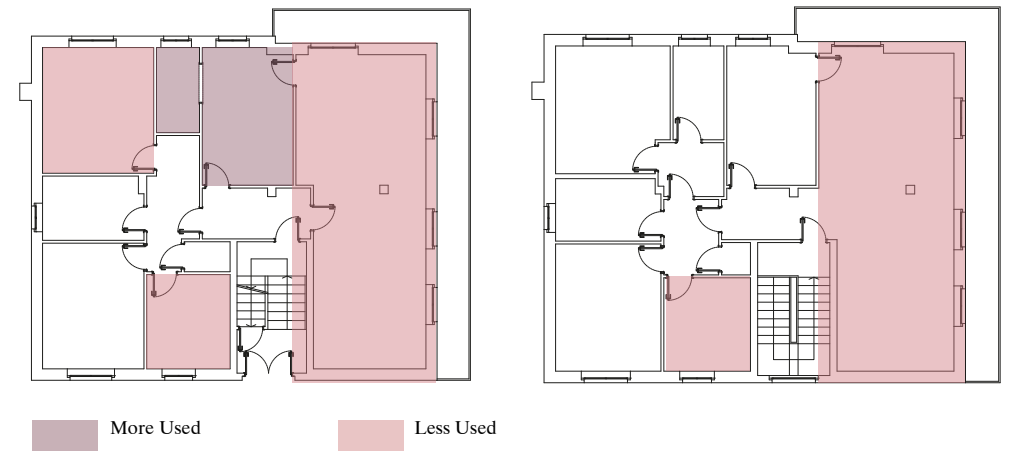

# DAVID, CRISTINA, MARIA, NOE' & FABIA'N

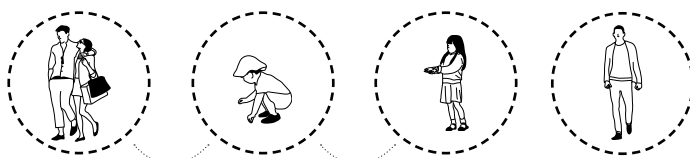

Madrid, Spain

The couple David and Cristina has two children, Maria and Noè. David works as firefighters and he has 24 hours on-call service; Cristina is a journalist in an important Spanish radio and she is really concern about the environment situation. When they are not working, they spend their free time with the family or doing sports, a hobby that the couple has in common. The children are both going to school and they are practising sports as well; Fabiàn a foreign au-pair from Mexico, is taking care of them and he is also teaching them English. He lived for almost all his life in the United States until he decided to quit his job for taking a gap year. In this gap year he is living with David and Cristina's family and during his free time he travels around Spain and Europe. Each of them has their own bedroom and the children are sharing one; there is also a studio that is using now by the children for playing. The living room is the most used space: for English lessons, for let the children play together and as gathering for the family.



4 rooms apartment

93,9 m<sup>2</sup>

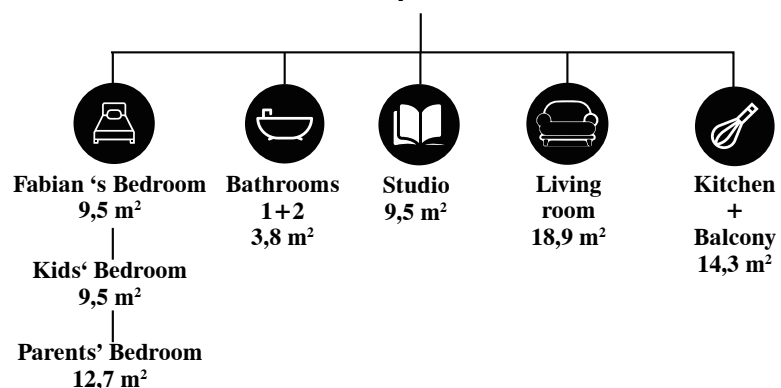



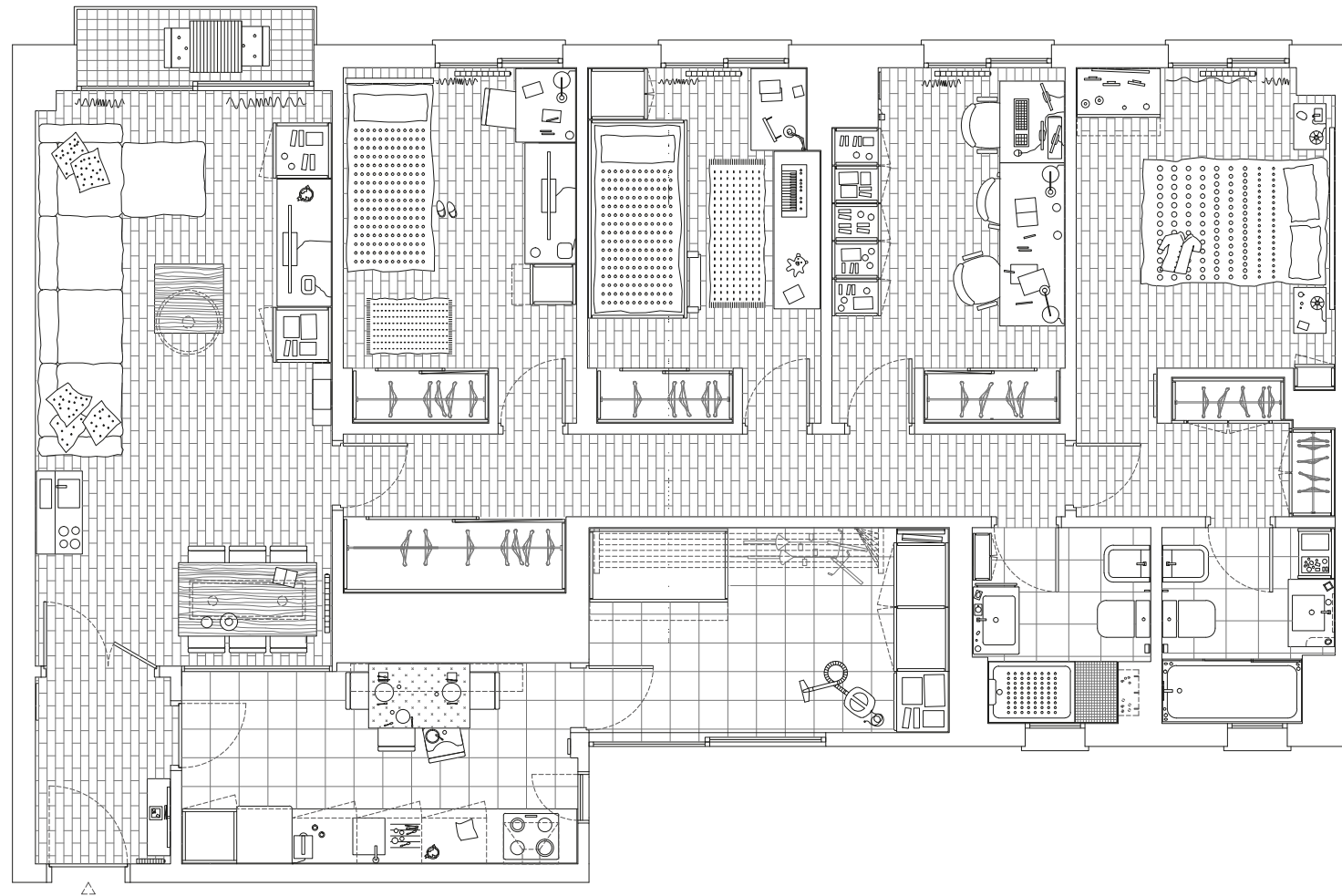
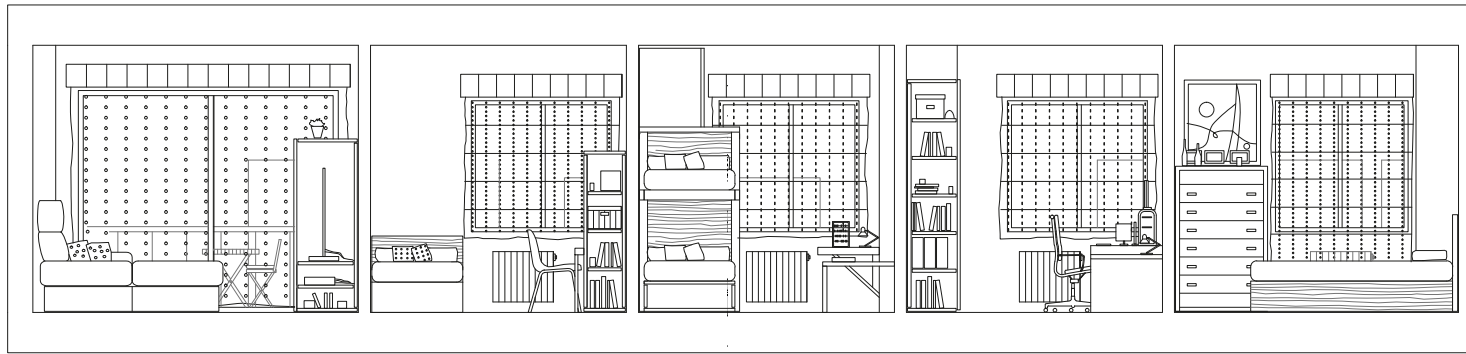

### Privacy levels

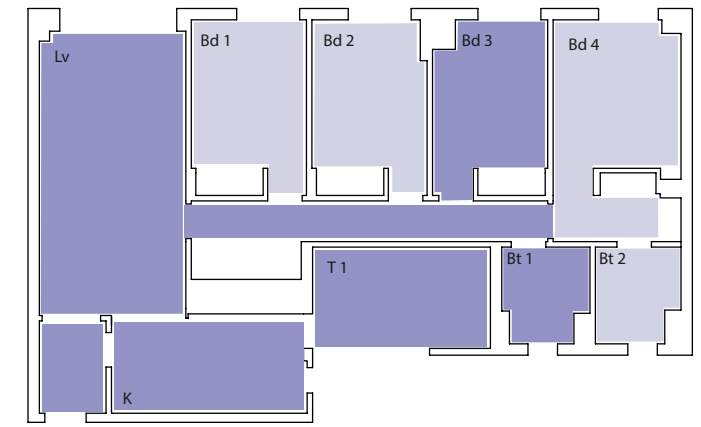

- Less Private
- More Private

### Usage of the space

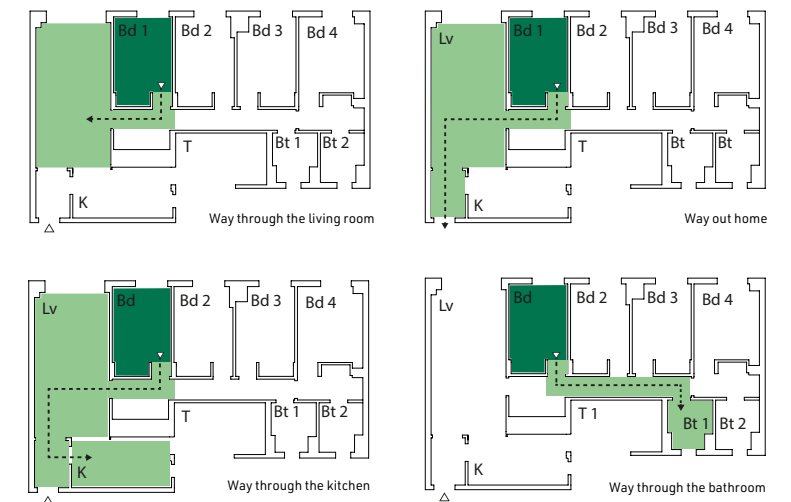

Au- pair's use of the house

- Private space
- Shared space
- Way

# MAREK, AGNIESZKA, SIX SONS & ZOFIA

Worker, worker, students, retired  
51, 48, 20, 18, 14, 11, 5, 9 months, 74 years old

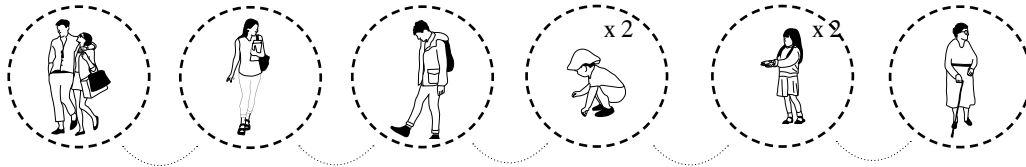

Wroklav, Poland

Zofia is Marek's mother, she is living in the ground floor and she does not spend much time with the rest of the family; sometimes she is cooking lunch when anyone can and she is taking care of the younger sons. Marek is working in an office and he is spending the most of the time there, while his wife Agnieszka, is now in maternity. The oldest daughter is studying architecture and some nights a week, she is working in a restaurant. The oldest son is Jakub a high school student. They also have Michael and Mateusz that goes to the elementary school, Maja in the kindergarten and Zurzia is still at home since she is too young. They are living in a detached house, the parents and their sons are living in the first and second floor, the second floor is a mezanine that was built in order to have more space for beds.



**3 floor house**  
**180 m<sup>2</sup>**  
**Family's floor**

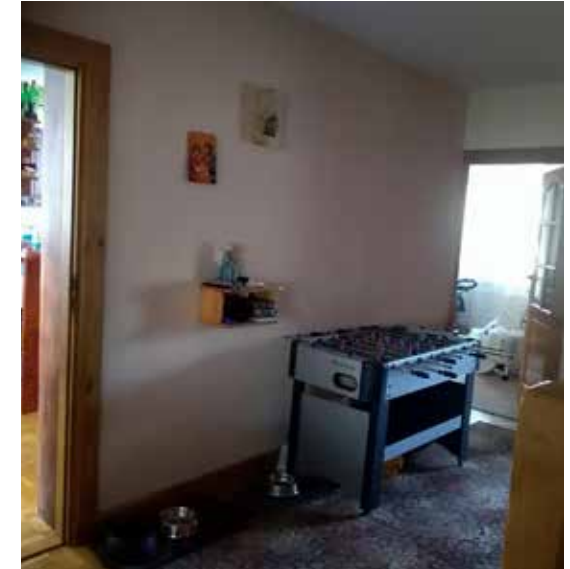
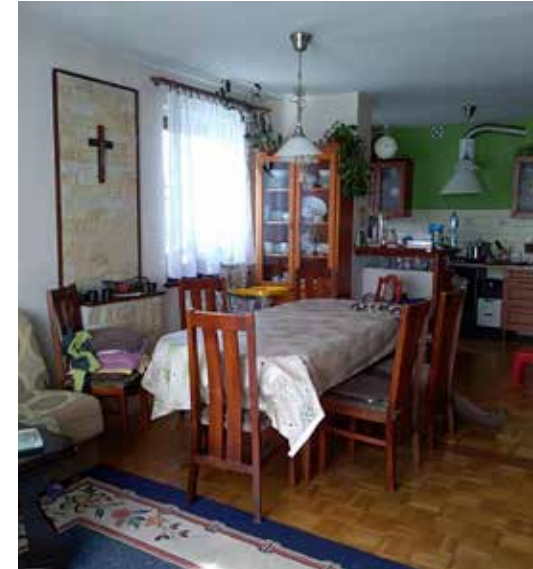
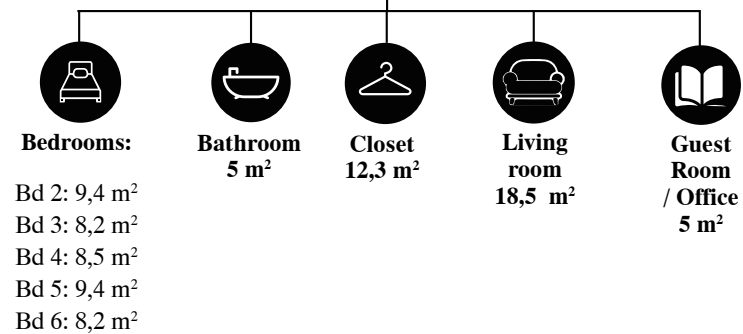

**3 floor house**  
**180 m<sup>2</sup>**  
**Zofia's floor**

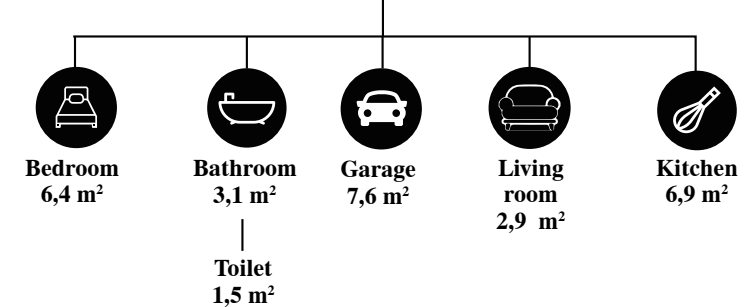

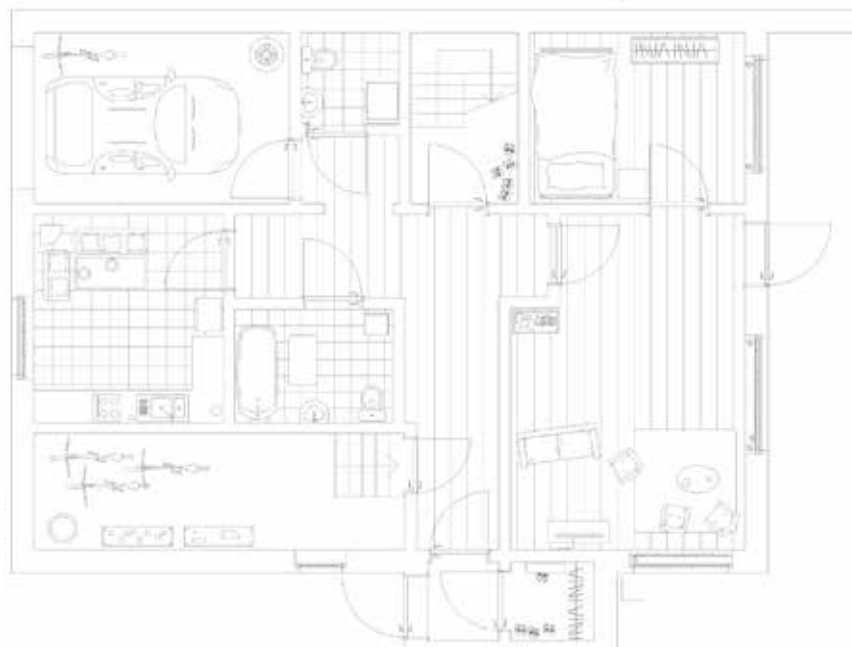

Ground Floor  
Scale 1:100

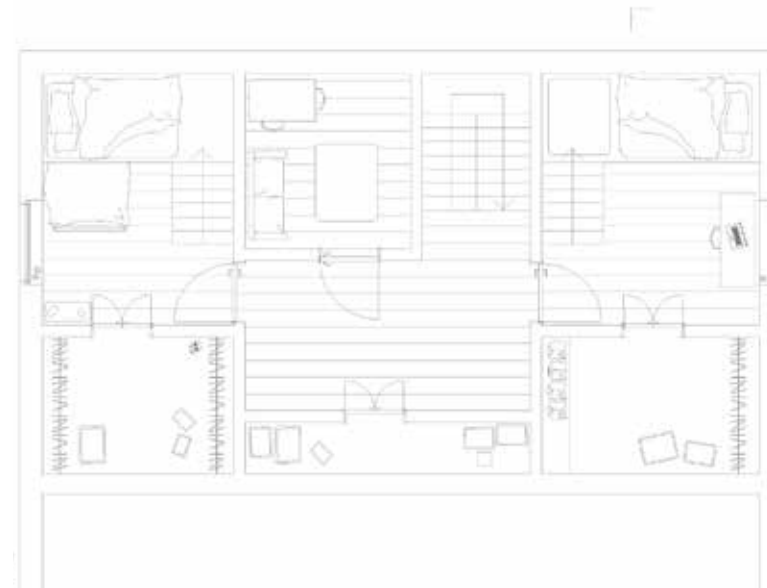

Second Floor  
Scale 1:100

### Privacy levels

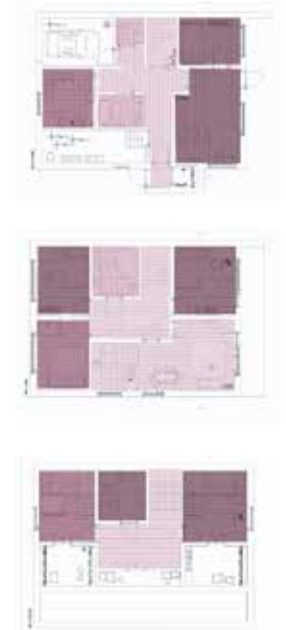

Darker for more private  
Lighter for less private



First Floor  
Scale 1:100



Scale 1:100

### Usage of the space

In this case the problem is the number of people living in same place. Usually the only place that they can be alone is bedroom. Teenagers can only meet friends there, however usually in the house is too loud and too busy to speak privately. To organize bigger party they need to get rid of at least half of the members from the house to for example use the living room on the 1st floor. In this case is also bathroom crisis in the morning and in the evenings. On the first floor is the big bathroom that is used by majority of the family. It is not enough, so when that bathroom is too busy they are using bathroom on the grandmother's floor. Younger boys also have the problem with sharing same room during night time and doing the homework

# CELAL, AYSEGUL, LODOS & CARLOS

Employed, Retired, Student, Exchange student  
54, 50, 18, 16 years old



Miami, USA

Celal and Aysegul are a married couple, they moved from Turkey to USA two years ago; they meet each other in aviation business where they worked as electronic and aeronautical engineer. Celal is working from home, so he spending a lot of times in the office room, when he is off work, he likes to relax in the living room with the wife and walk in the park. Aysegul is retired, she spends her time tidying the house and meet with friends. Their young son, Lodos is preparing himself for collage acceptance, he likes playing videogames. Carlos is an exchange student for one year from Mexico, he likes playing tennis and watching tv. The family is spending time together during dinner and lunch times and sometimes after the dinner in the living room, where they watch movies together.



4 rooms house  
340 m<sup>2</sup>

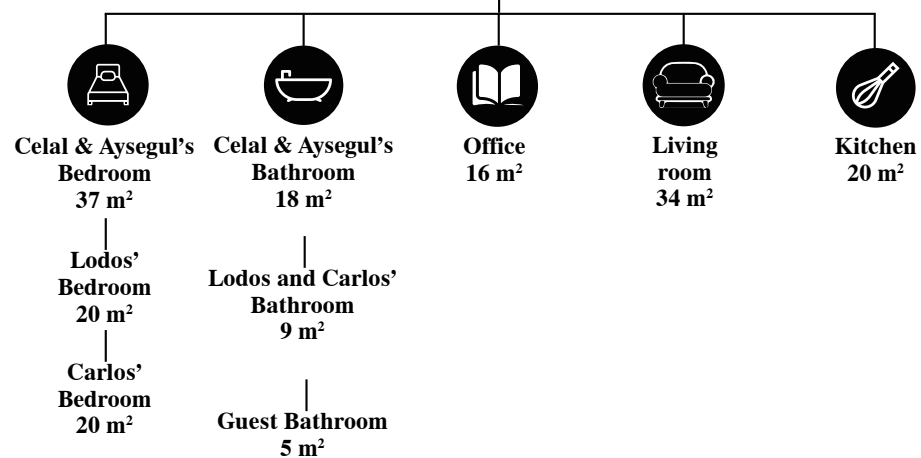

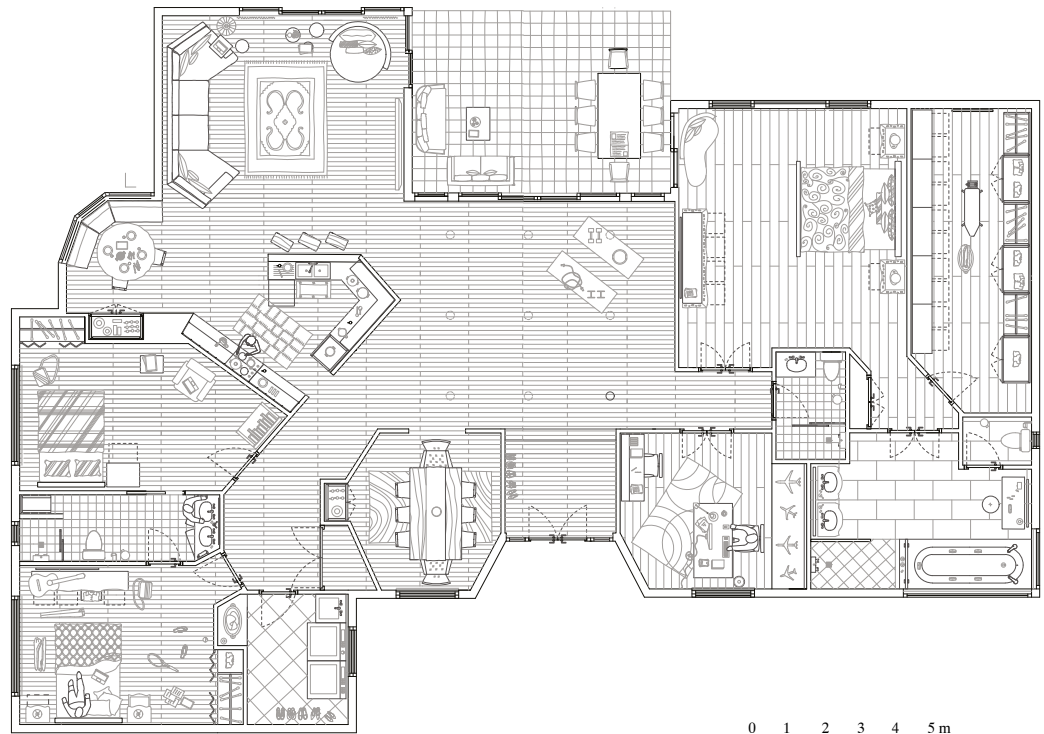

0 1 2 3 4 5 m



### Privacy levels

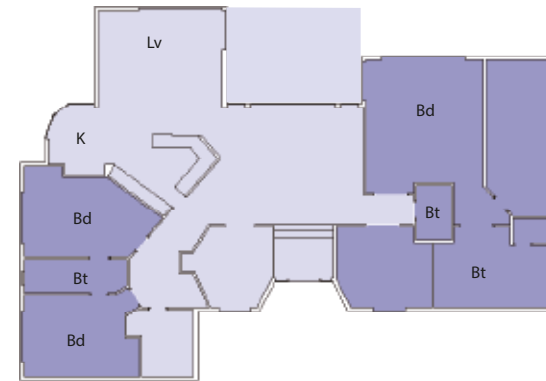

More private  
Less private

### Usage of the space

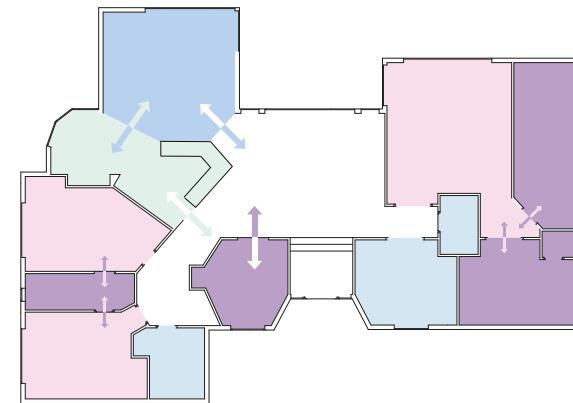

Rooms (with additions)      Free plan area with different functions  
 Additions      Service Area  
 Enclosed singular rooms

# ALICE, ANDREA, MARCO, MIRELLA & NAOMI

Student, Student, Hairstylist, Housewife & Student  
5, 7, 39, 43 & 21 years old

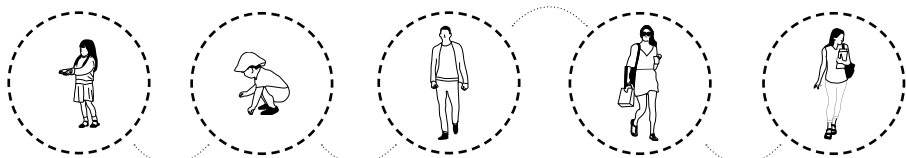

Milan, IT

The family is composed by a brazilian mom, Mirella and her daughter Naomi, Mirella's partner Marco and their sons Andrea and Alice. Mirella is an housewife and she likes paintings, while her partner is an hairdressers. Naomi is Mirella's daughter, she is half Brazilian and half Japanese and she is studying architecture in university. Mirella and Andrea have one son and one daughter together: Alice and Andrea which are studying at the elementary school; both of them are practising sports, football for Andrea and dance classic for Alice. They are living in a good harmony all together since each of them have his own privacy; the space where they are spending more time together is the living room and the kitchen.



3 rooms house  
127 m<sup>2</sup>

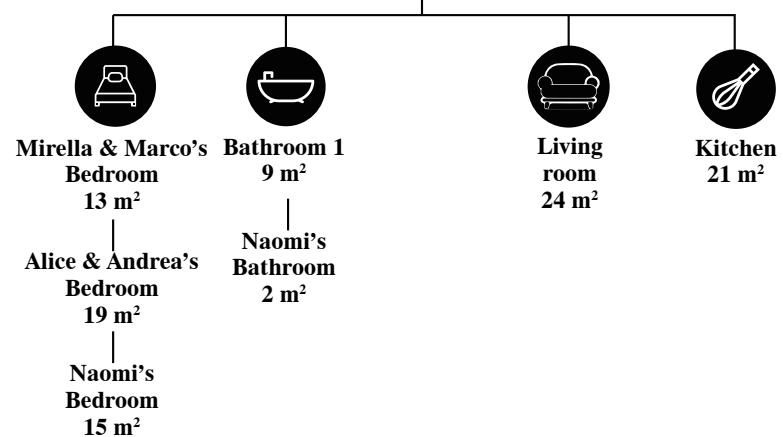

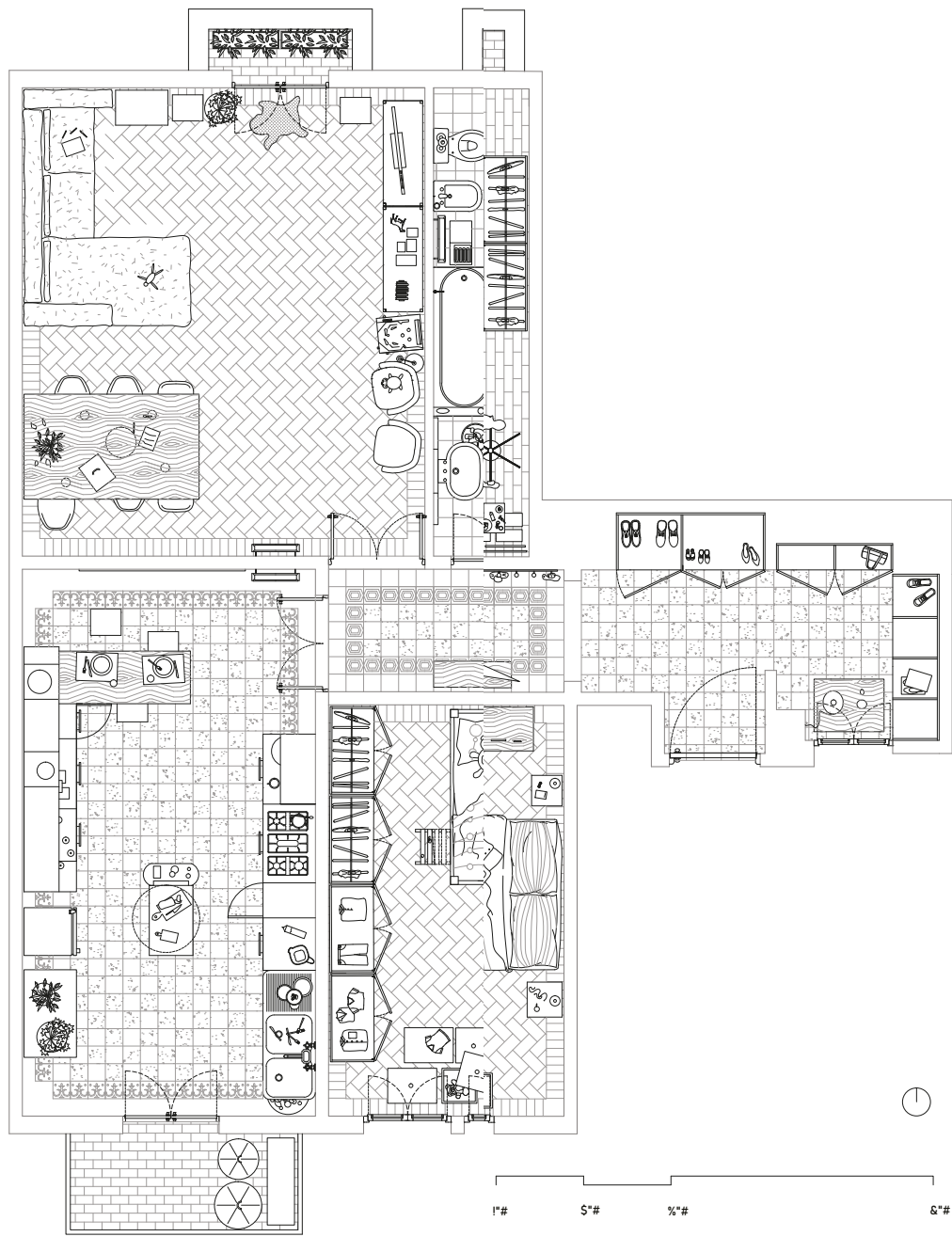
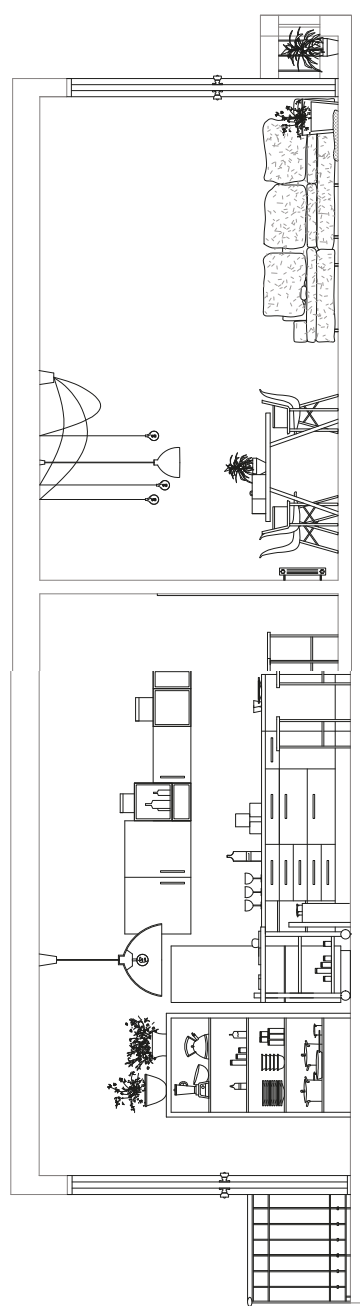

### Privacy levels

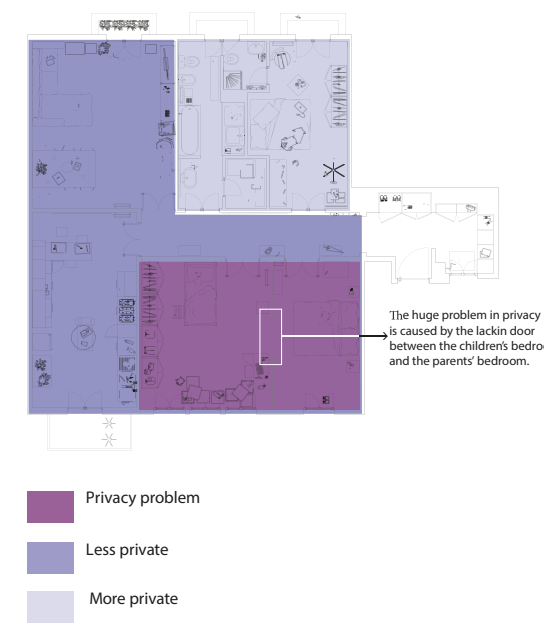

### Usage of the space

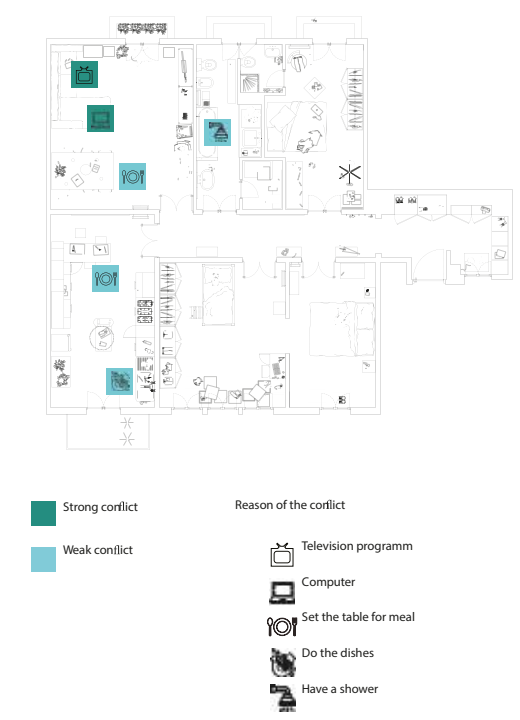

# GIOVANNA, CONCETTA, NATASHA & GIANPIETRO

Pensioner, Worker, Nurse & Student  
83, 53, 25 & 16 years old

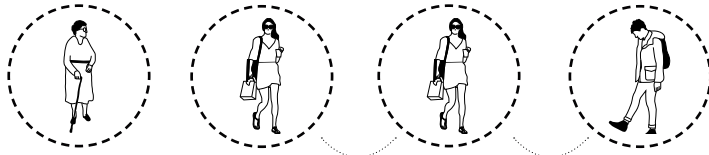

Carpi (MO), IT

The oldest member of the family is Giovanna, the mother of Concetta. She decides to leave her original city and moved with her daughter when her husband died; she stays with her during autumn and winter period, while during spring and summer she goes back to Lecce. Concetta is really happy that her mother lives with her, they can spend some time together and she can be helpful with domestic crafts. Concetta in fact, is a really busy woman: she spends the whole days of week at work and during the weekend she likes to travel with her partner (she divorced from her husband ten years ago). Her daughter Natasha is a nurse, she is the one who is living more independently from the family since she is doing different work shifts every week; she shares the room with her grandmother and sometimes during the weekend she has to take care of her brother Gianpietro. He is still in high school, he likes spending time with his animals, with friends and playing videogames.



5 rooms house

160 m<sup>2</sup>

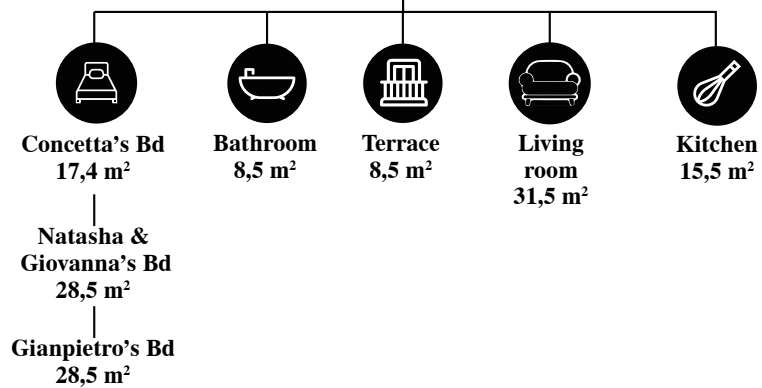





### Privacy levels

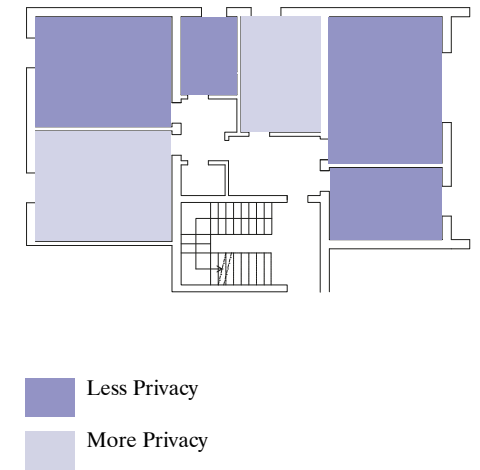

- Less Privacy
- More Privacy

### An uncomfortable situation

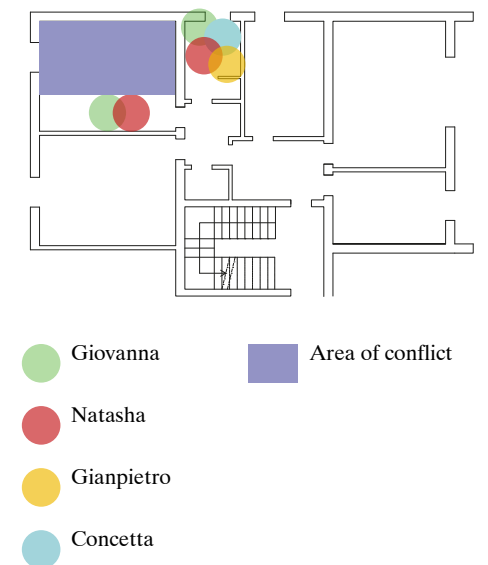

# PATRIZIA, FEDERICO, LUDOVICA & BENEDETTA

Employee, Student, Student, Employee  
56, 18, 14 & 56 years old

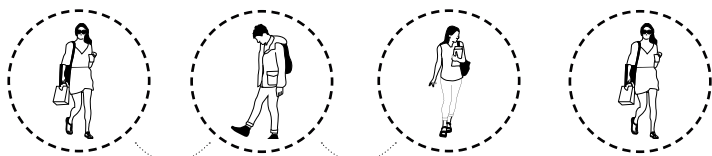

Milan, IT

The family is composed by Patrizia, her son Federico and her daughter Ludovica and a friend of her from high school Benedetta. Patrizia is working in Mediaset company, she loves sport and she transmits her passion to her children, who are forced to train as agonist in the swimming pool. They are respectively 18 and 14 years old, they are both students and swimmer agonist; however, if the first son is more into fitness and aesthetic care for himself, the girl is shyer, she has less friends and she would like to stop train that much. They love Benedetta, a friend of her mother from high school and now her colleague; she is a strong independent woman and she is single. Her role in the house is to help with house crafts and shopping food, since Patrizia is really busy.



3 rooms house

109 m<sup>2</sup>

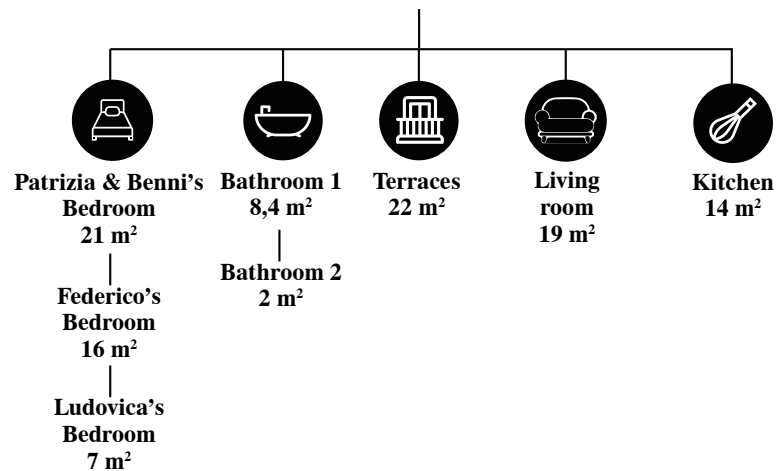

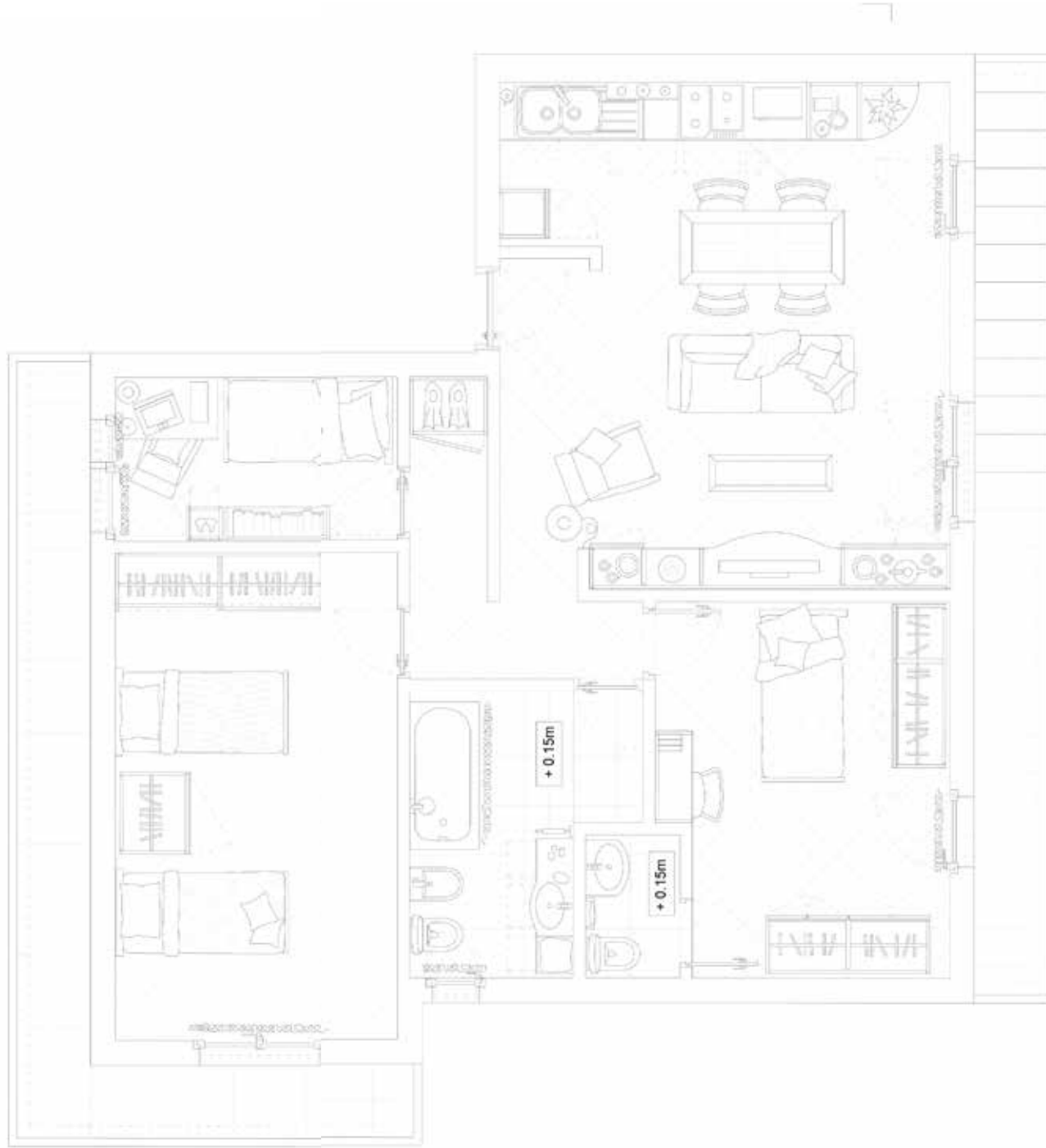
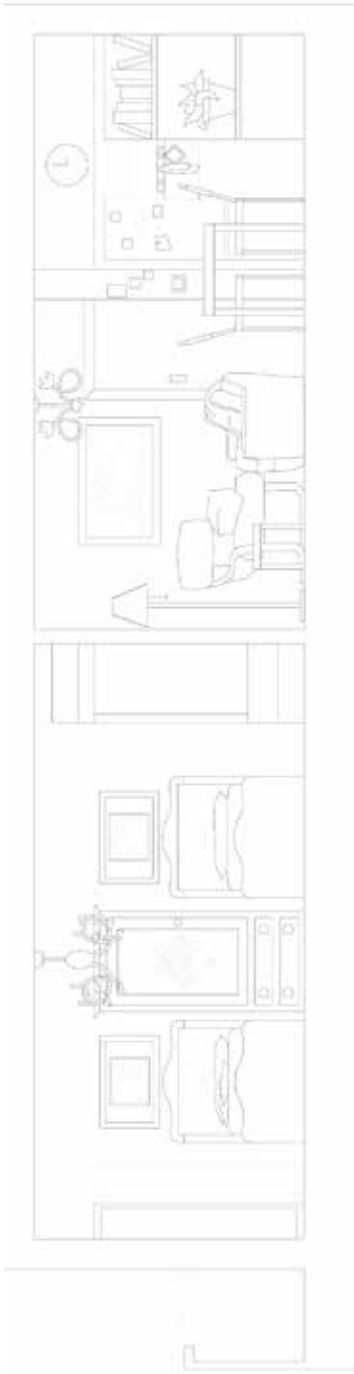

**Privacy levels**



**An uncomfortable situation**



# CLAUDIO, MILO & AIR BNB GUEST

Circus man, Employee, Tourist  
59, 25 & variable years old

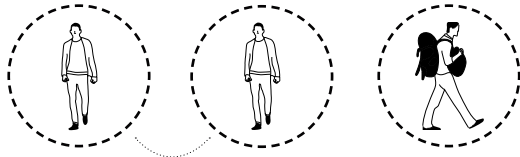

Milan, IT

The family is composed by Claudio and Milo, father and son; the father was a circus man and Milo is the owner of a craft brewery and a distributor of the brand "Itinerant Pub". They have always lived in the house with Claudio's mother and his three siblings, who left the house for different reasons. The house is too big for two people, for this reason Claudio chose to rent a room to Air' Bnb and he is having a great success. Thanks to the characterises of the house, that recall a circus, the house became really popular on the website and they are receiving guests almost every day. The main occupation of Claudio today is so taking care of the house and menaging the guests, but he is also constructing a small theatre in one room, where he can do small circus shows for children. Father and son have totally different time-table, they are not meeting often especially during dinner time.

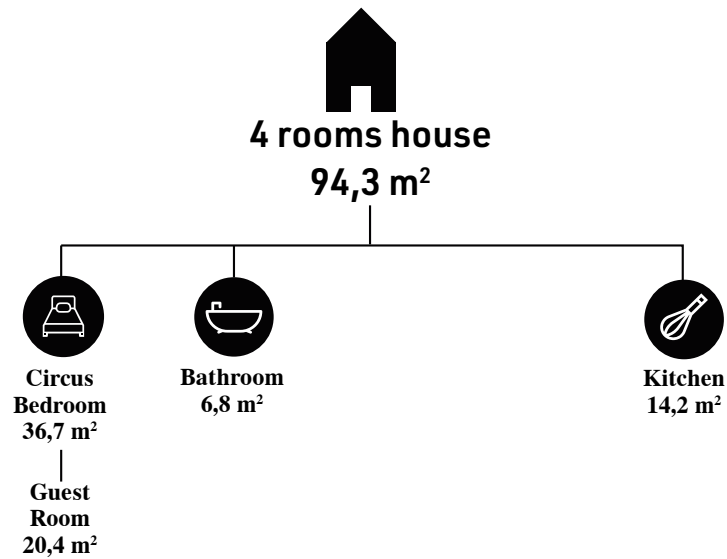

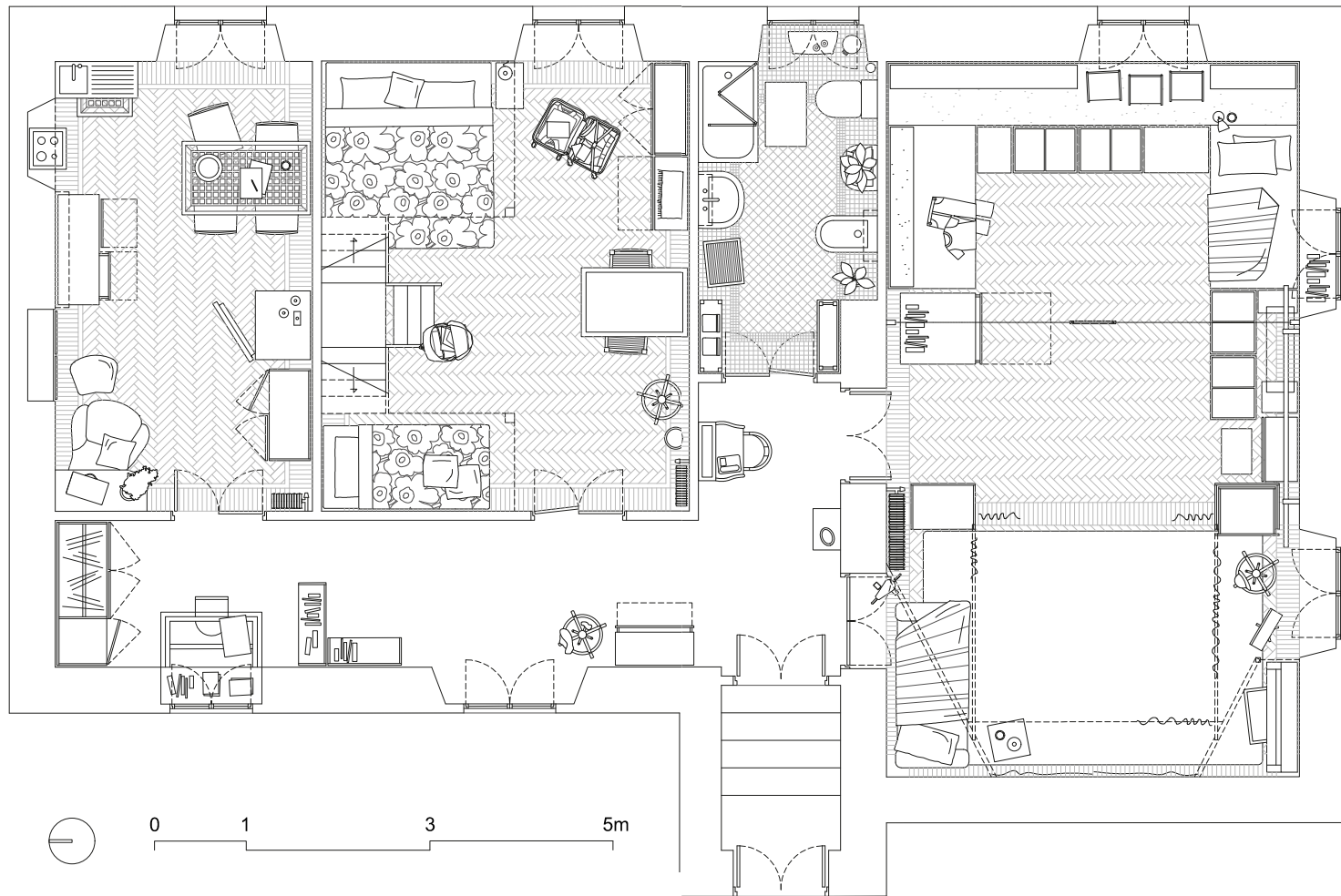
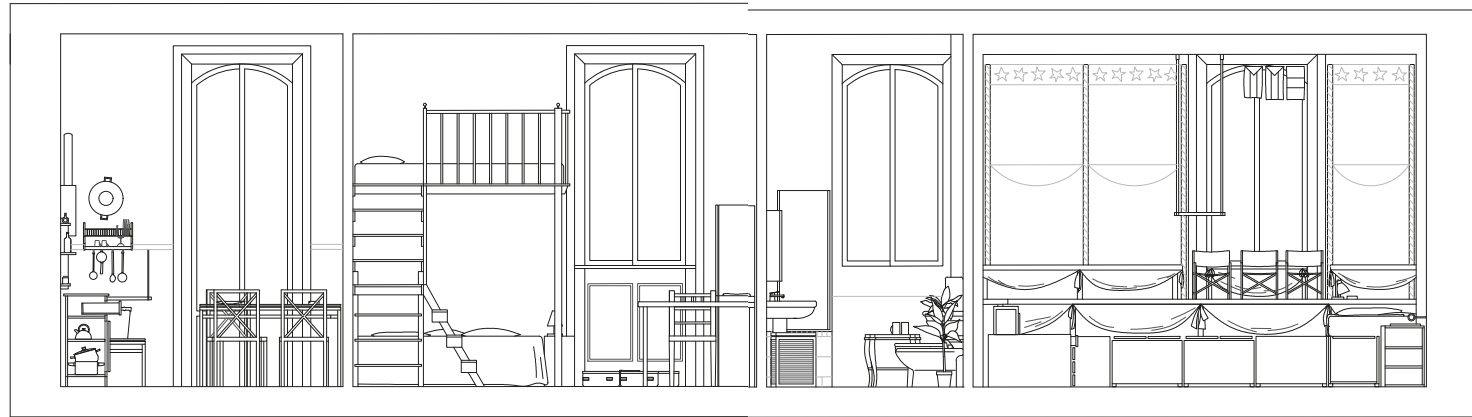

## Privacy levels

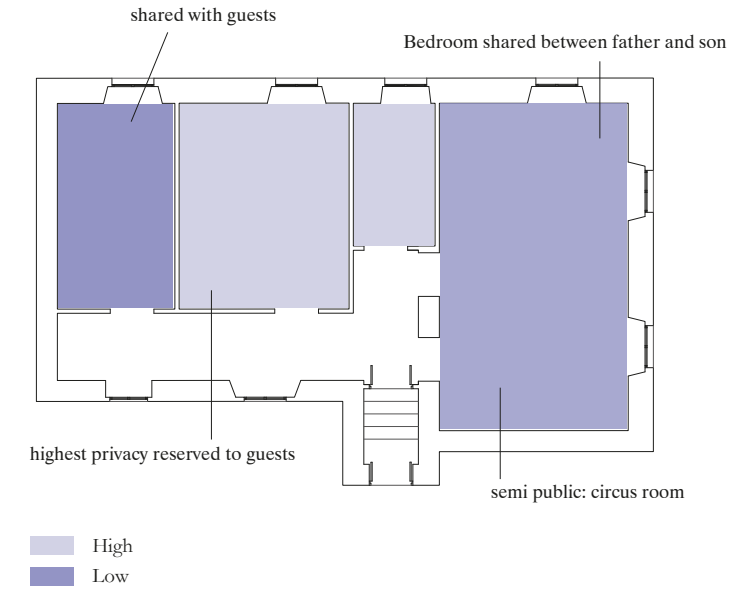

## An uncomfortable situation

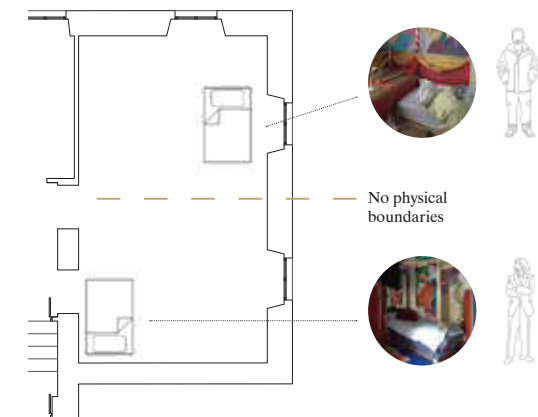

\_ Starting to rent the room on AirBnB, the privacy of the family decreased since kitchen and bathroom are shared with the guests.

\_ The circus' setting reduced the privacy level even more, since father and son started to sleep in the same bedroom

\_ Lack of individual space is causing conflicts: example they normally can't have guests staying for the night beside of the AirBnB ones

\_ Not having a living room also makes harder to find space for not being alone

# LICIA, DORA, PIETRO & ANTONIO

Student, Student, Retiree, Student  
20, 22, 70 & 16 years old

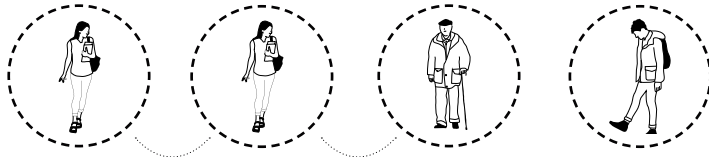

The owner of the house is Pietro, a retiree man of 70 years old who hosts in his house his nephew and two sisters, that are not blood-related to them. Antonio is living with the grand father because his parents have moved to Geneva for work, he is studying in the cooking school and as soon as he will finish his education, he will reach his parents in Geneva for work. The two sisters, Licia and Dora, moved from Viterbo for studies, they are both at university. They have a different life, Licia is more diligent and dedicated to school, while Dora spend a lot of time outside in university or to catch up with friends. They made an agreement with Pietro: they will pay a lower rent in exchange of domestic works, cooking dinner and help Antonio with homeworks. Pietro on the other way is happy to have guests in the house: he is not feeling lonely and he is increasing his monthly income.



**3 rooms house**  
**109 m<sup>2</sup>**

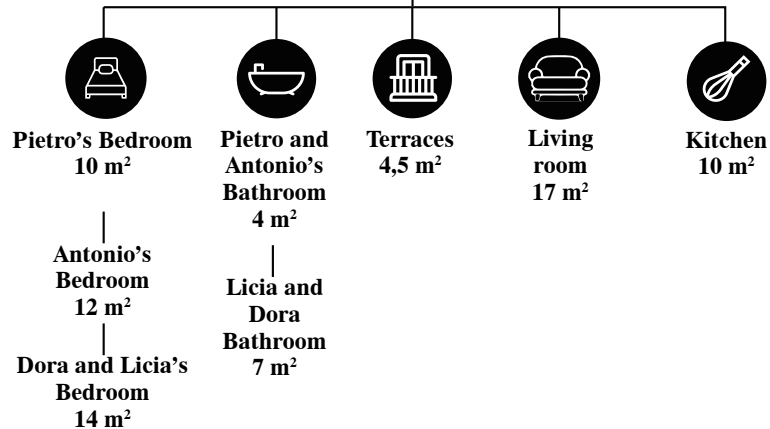

## Privacy levels

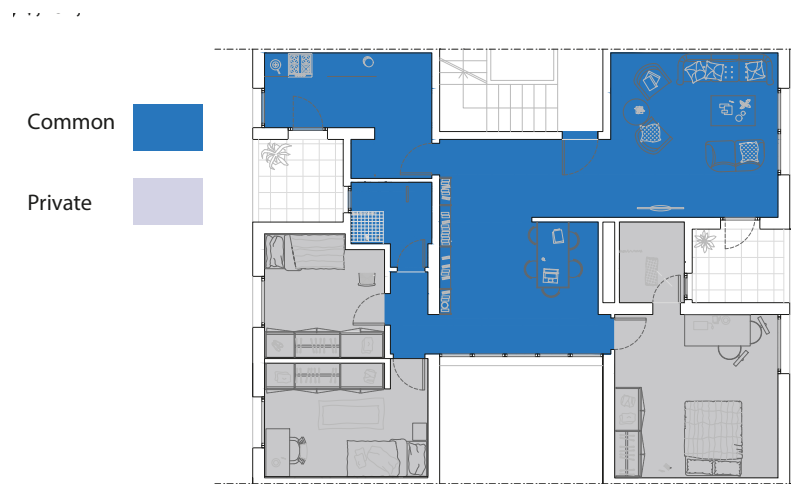

## An uncomfortable situation

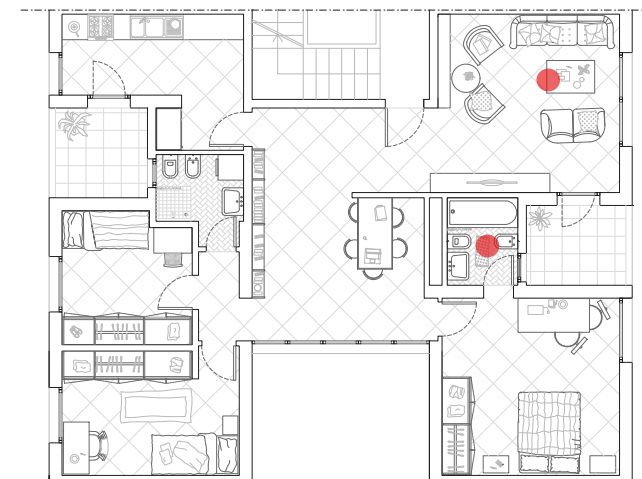

● Points of conflicts

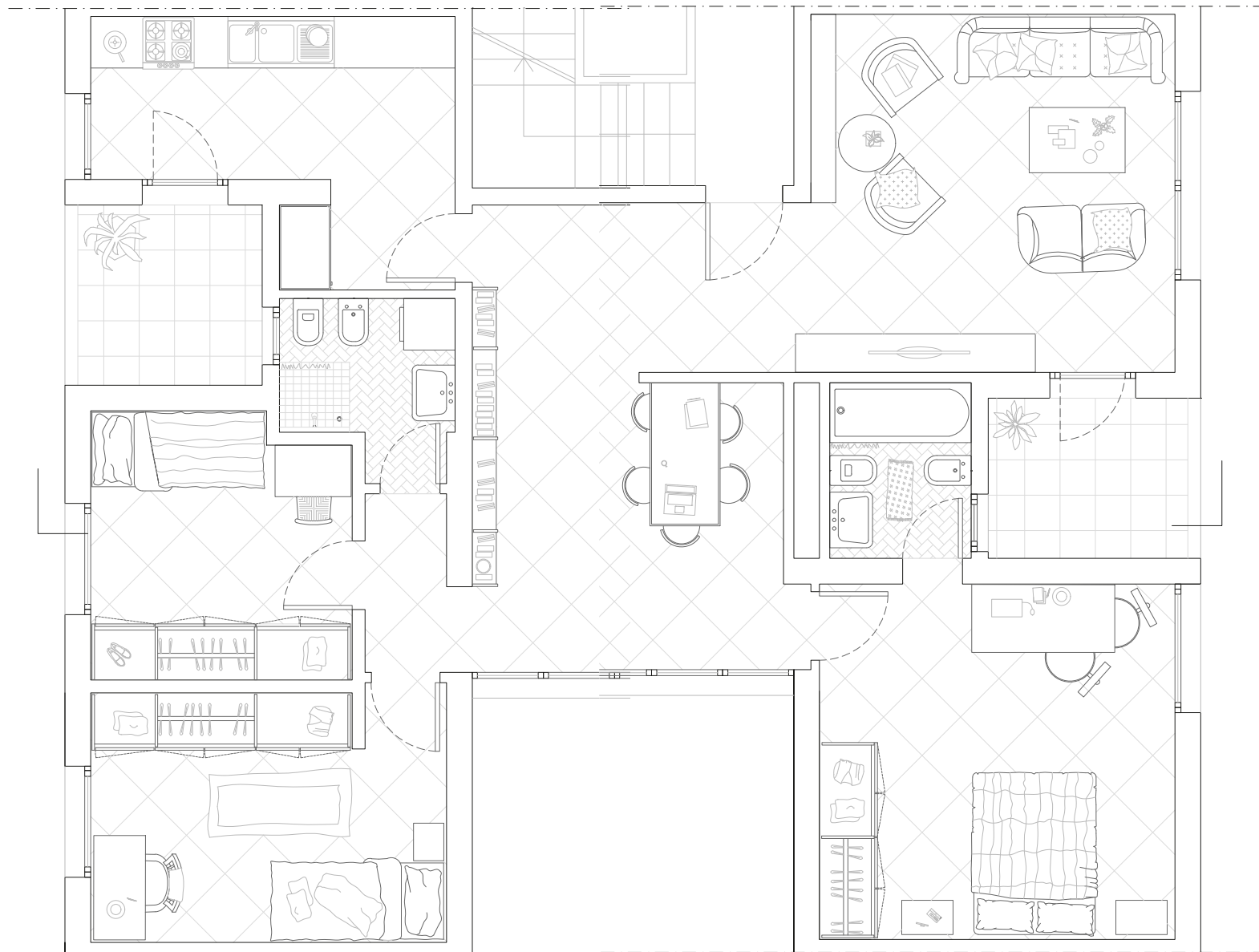
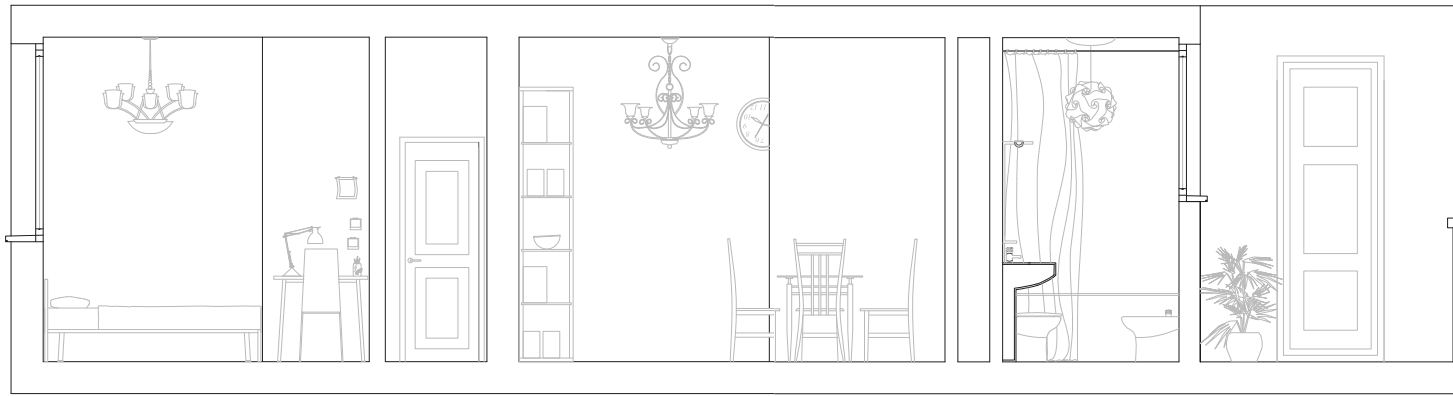

# TYPE F

FAMILY + FAMILY



X 2

The category includes households composed by different families living in the same place. In the most of the case all the families have children, even if there are some exception with families without children. The co-habitation is more complicated: in order to create a nice living environment there is the necessity of a bigger space that can include bedrooms for everyone and a common space for each family. Unfortunately, sometimes this is not respecting the reality, in case of a Kommunalka building for instance, each family is forced to live in one bedroom and sleep all together despite their age. In other cases, the original nuclear of the family have the economical and space availability of hosting an extra family. This is the category where the cohabitation is used for saving money and have the company of other people.



# PAOLA, PAOLO, LUCA & IRINA, ISABEL

Worker, Worker, Student & Worker, Student  
53, 50, 18 & 45, 16 years old



Valdengo (Biella), IT

The house is composed by two families: the first is made by Paola and Paolo, wife and husband, and their son Luca. Paolo is often far from home during the week, so he spends as much time as possible with his family during the weekend; sometimes they are going to ski or for small holidays. Since his husband is far from home, she decides to include a second family in the house, composed by Irina and Isabel. Irina came from Russia to Italy many years ago, she got married with an Italian and they have a daughter call Isabel. Irina and Paola are in good relationship, they spend a lot of time together, especially in the kitchen; also, Luca and Isabel became close friends, they are going out and watch movies together. There is a nice harmony in the house and each person has his own private space.



9 rooms house  
220 m<sup>2</sup>

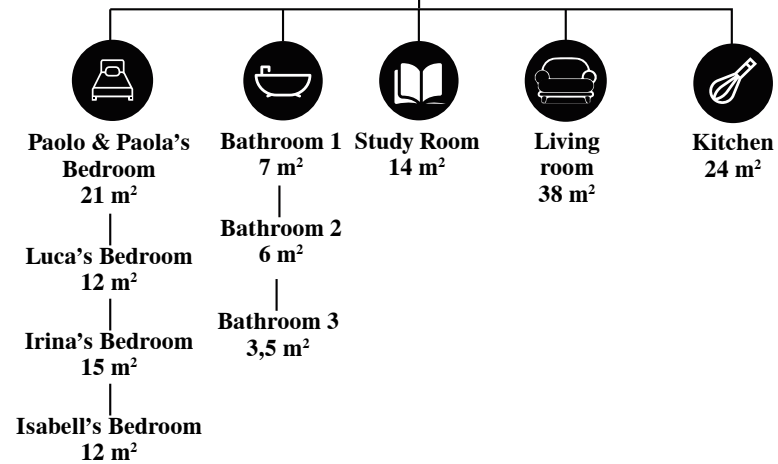

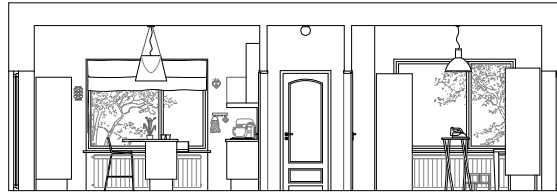
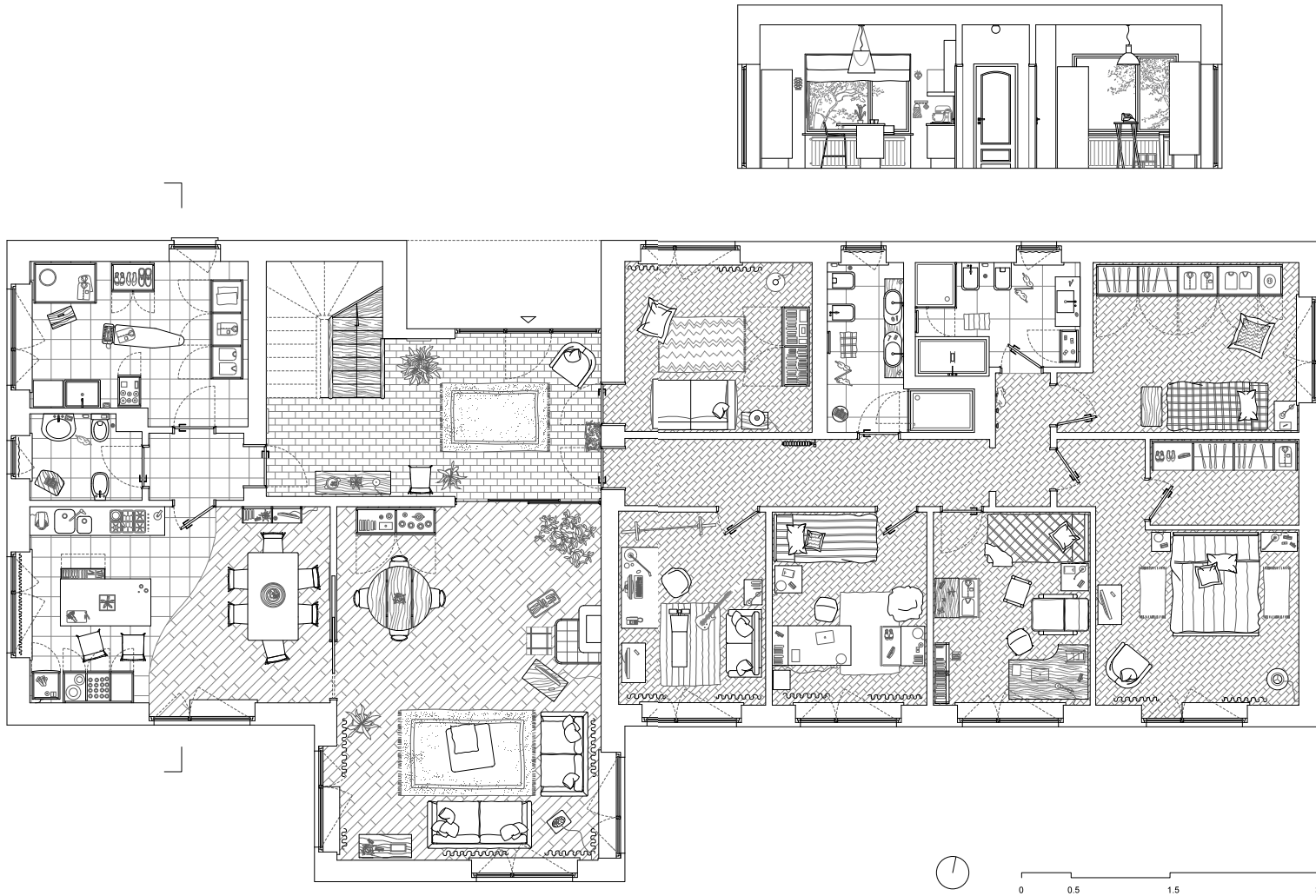

Privacy levels

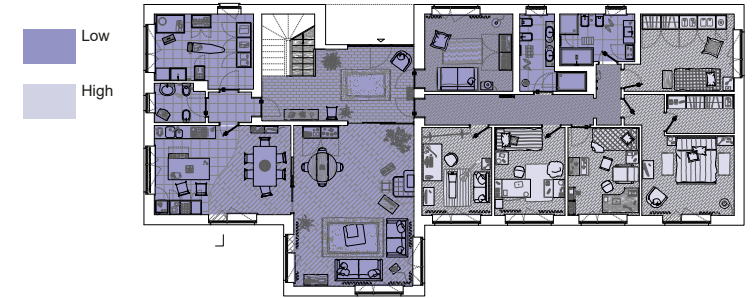

Usage of the space

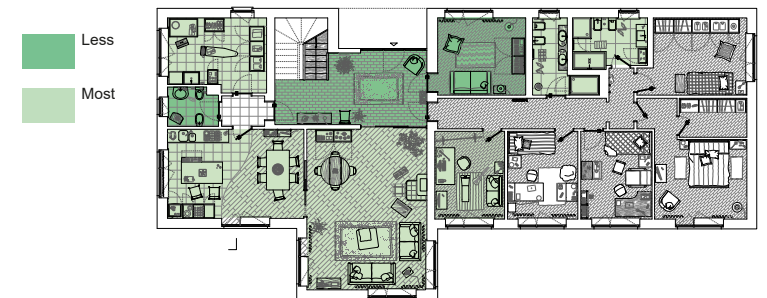

# ELENA, IGOR, VLADIMIR & SLAVA, YULIA

Worker, Student, Unemployed & Worker, Worker  
35, 10, 31 & 42, 33 years old

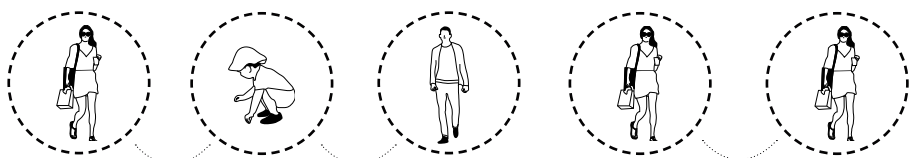

Saint Petersburg, Russia

The two families are living in St. Petersburg in a Kommunalka building. They are sharing one of the four apartment available at the third floor; while with the other people of the building they are sharing the heating system, electricity, water, internet and tv. The apartment has only two bedrooms, each family is sleeping all together in one room. The first family is composed by Elena, her husband Vladimir and their son Igor. Elena is the only one who is working, she is working in an insurance agency, while Vladimir is currently an unemployed. The other family is composed by Slava and Yulilia a couple that teach flamenco for work.



2 rooms house  
51 m<sup>2</sup>



Bedroom 1  
18 m<sup>2</sup>



Bathroom  
5 m<sup>2</sup>



Kitchen  
8 m<sup>2</sup>

Bedroom 2  
9,5 m<sup>2</sup>



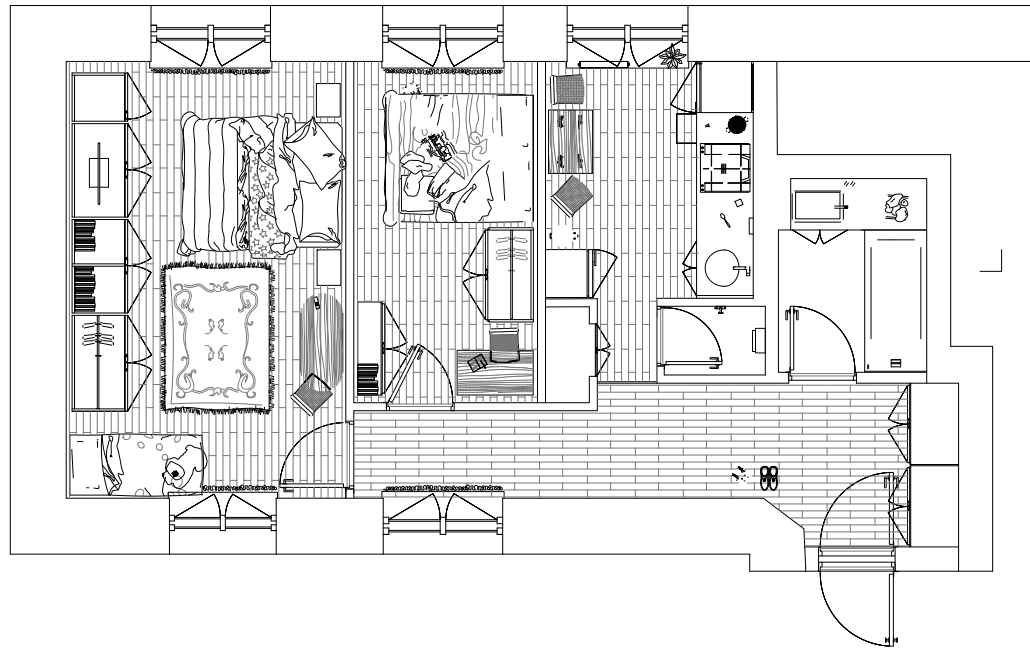
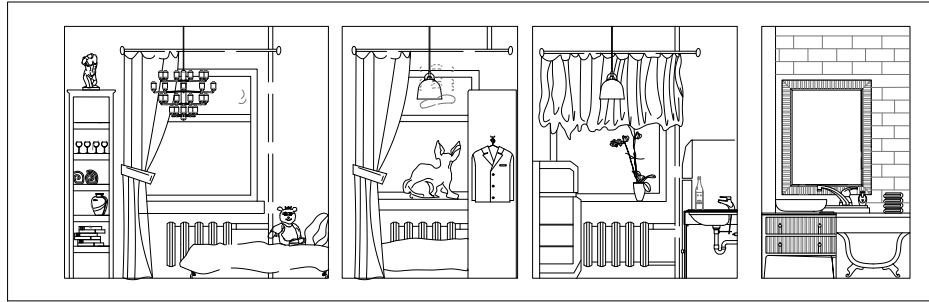

### Privacy levels



- More private
- Less private

### Flows of the residents



# THREE FAMILIES

ZHANG YILIN, WANG WEI, WANG KEXIN & CHEN LEI, WANG LEI, ZHANG CHUNHUA

Retired, Retired, Employed & Employed, Employed & Retired

61, 63, 25 & 54, 56 & 91 years old

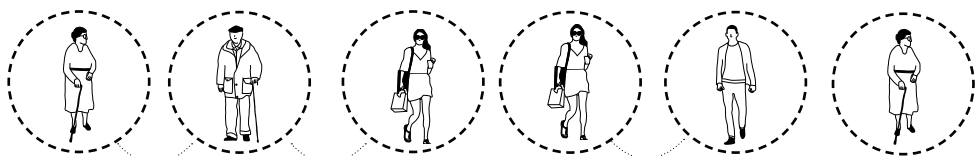

Shanghai, China

The families are living in one of the typical chinese residentials call Shi Ku Men, a cheap and easy build solution where the apartment in one floor contain several rooms for each resident, plus kitchen and bathroom shared. The first member is Zhang Chunhua who is living in this house for almost sixty years; she moved here with her husband and children, now her husband passed away and her children left the house, so she is alone and a nurse maid is taking care of her. Wang Lei and Chang Lei are living in the first floor, they are both employed, Wang is a college professor and Chang work in an educational institution. Zhang Yilin and Wang Wei are married and retired, they have a daughter Wang Kexin who is still living with them. All the families are helping Zhang Chunhua and everyone is felling strong attached to the others member of the Shi Ku Men.



9 rooms apartment

155 m<sup>2</sup>

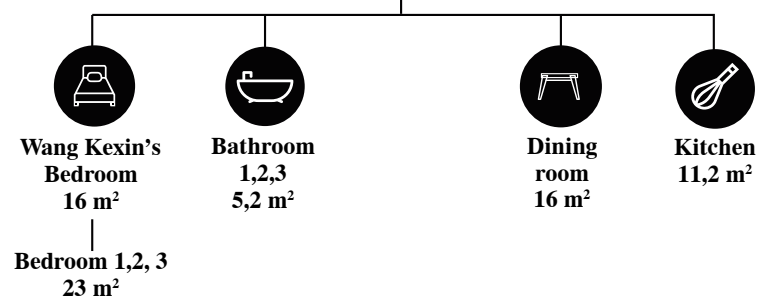



Section AA'



Ground Floor Plan



Section BB'

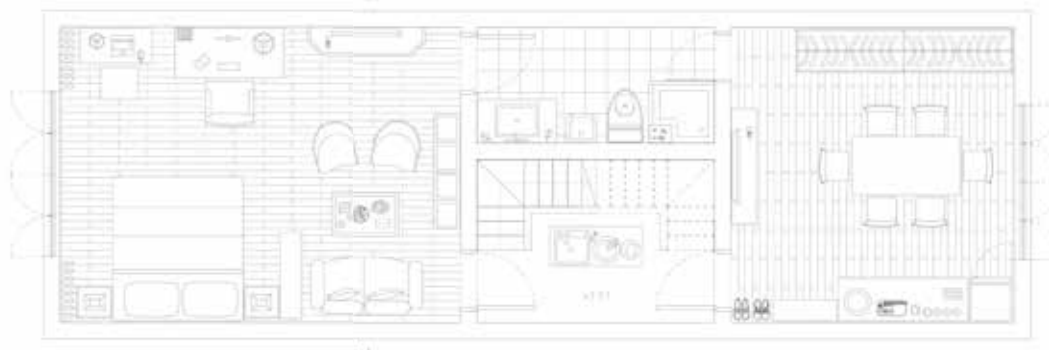

First Floor Plan

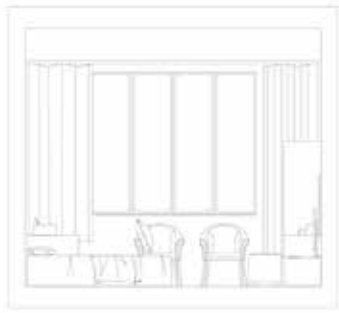

Section CC'



Second Floor Plan



**Privacy levels**

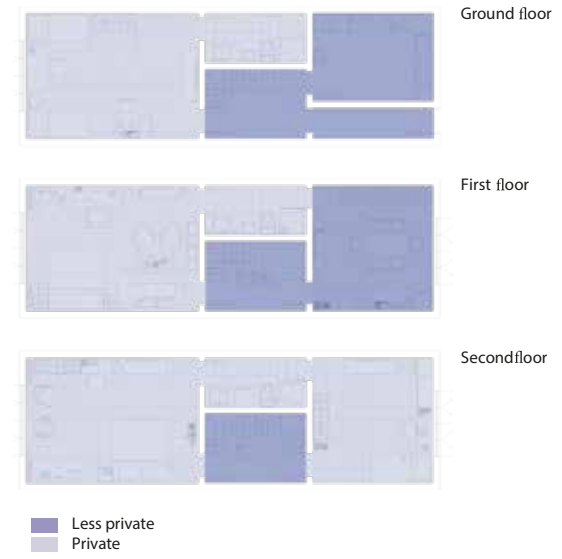

**Flows of the residents**

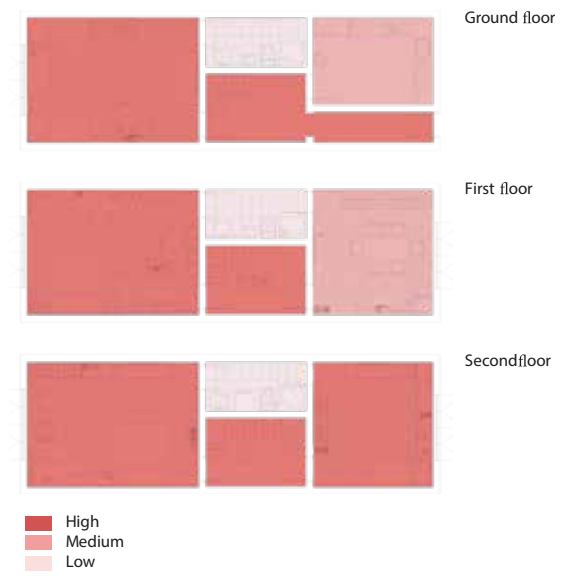

# TYPE G

## UNCONVENTIONAL HOUSING CONDITIONS

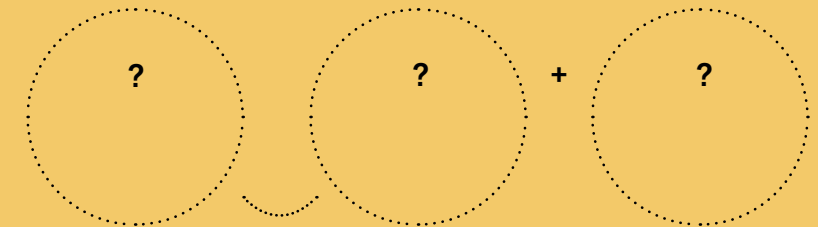

The last categories summarize families who can not be classify in a specific group, since they are a mix of the previous ones. The case that we analyse find multiple and variable situation, where is visible a deep change in what a family is in our decade. We have a family with sons that are not at home anymore, except one who is disable; there is a couple composed by worker divorced adult who had children before, there are couple in the same situation that are living all together with or not, the presence of the new children of the new couple. Then we can find families where one member of it lives in another household; cousins and uncles who are living together and then family who adopt foster children. The cohabitation in this case is mainly due to a social issues and new family formation; in this cases, is harder to define what a family is, since some members of the case analysed, had already a family before.

# MARIO, GIOVANNA, ELISA

1

Retired, Retired, Disable  
80, 76 & 48 years old



Brescia, IT

Mario and Giovanna, married from almost fifty years, are living in their villa with one of their four children, Elisa. Mario and Giovanna came from poor families, but they work hard in order to create their own construction company, which today has a great success and it is under responsibility of their sons. They are now retired but still, they help in the company every morning with some tasks that can be useful; Giovanna on the other way is more dedicated to the family issues and she spends a lot of time at home. Elisa is a disable and so she is not totally independent from her family, she likes to spend time in the company as well, when she works on little tasks that helps her to be busy and get responsibilities. They are living in a nice villa of 1000 m2 situated in the Po valley.



5 rooms villa

300 m<sup>2</sup>

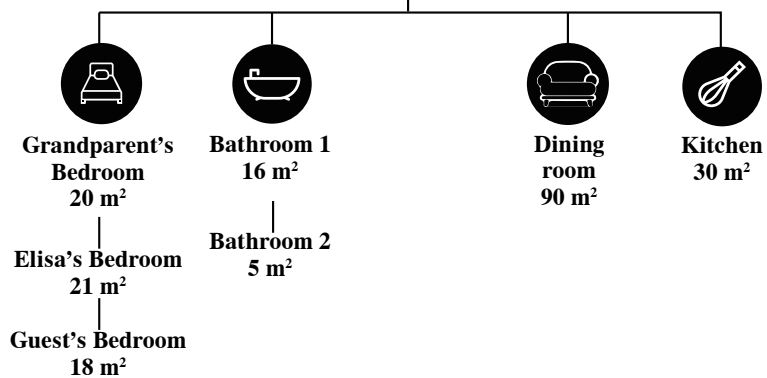



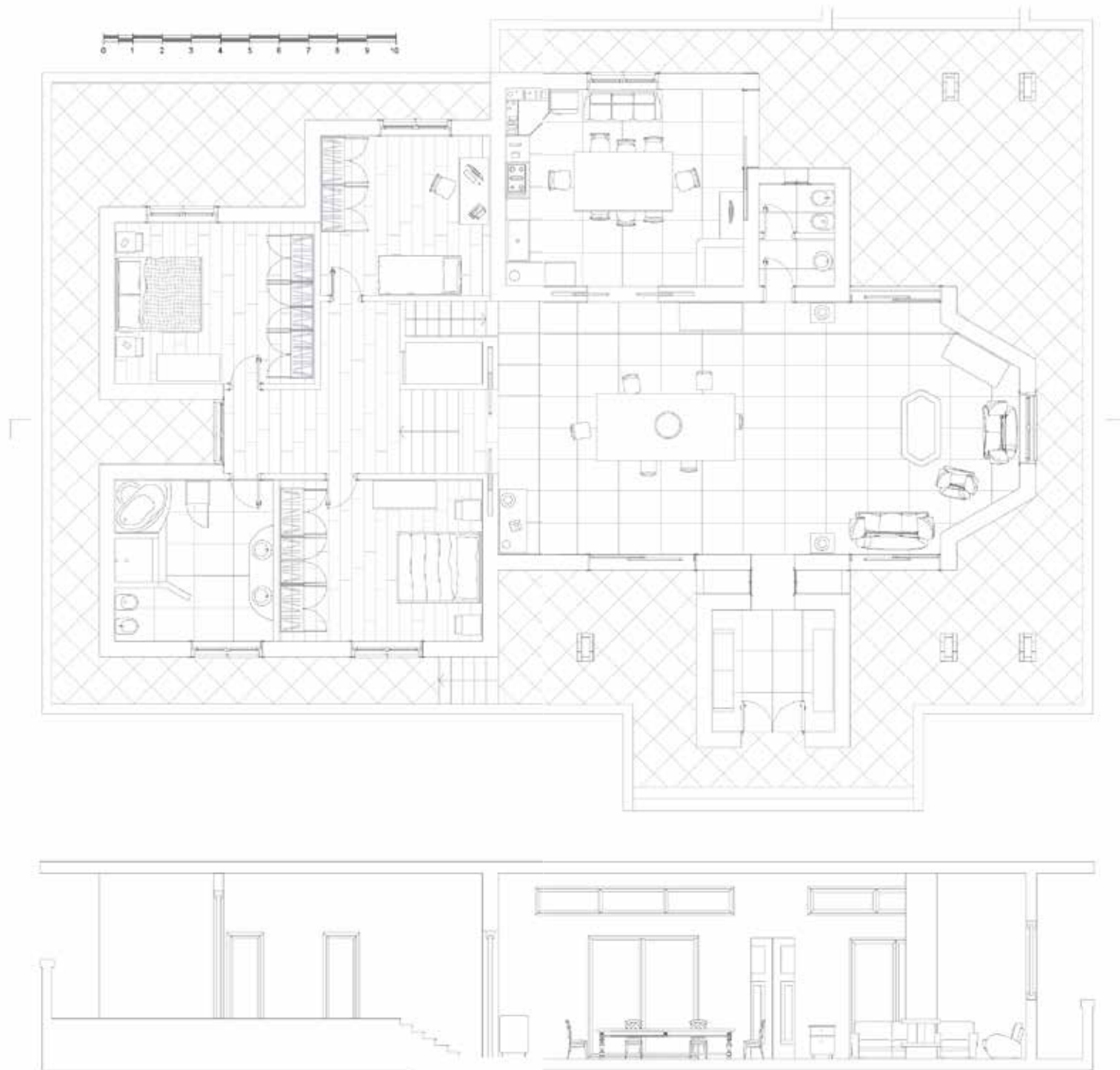

## Privacy levels

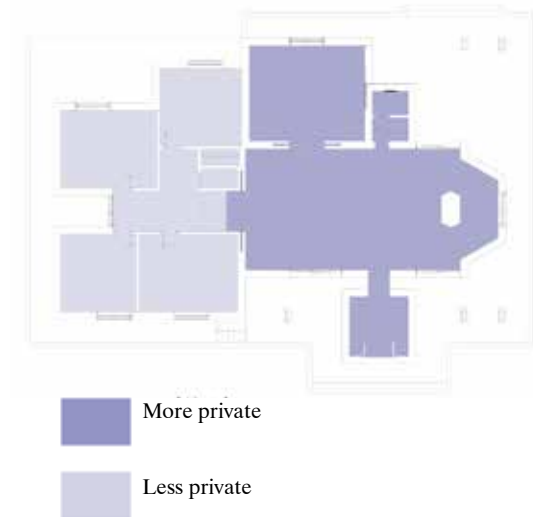

## An uncomfortable situation

In 2018 the villa is twenty years old and this start to have some effect on the tecnological aspects.

\_The roof have a breach on little side of the living room and when is raining a lot the water seep inside.

\_Also the AC is having some problem to feed all space for a lack of power.

\_The swimming pool mosaic is suffered the climate over the years such as the water filter

\_The gates of the garage are a little bit small for big cars

There are also two main critics that are not strong related with the previous, like the fact that the proprierty is far from the village so also the social relationship with other people is an aspect that affect in the first place Elisa as a mental dis-able, becuae this situation is like if she's in a fancy bubble disconnected from the rest of the world.

The other main aspect is the fact that the house divided into three floors, so the habitants struggle, for their age and fical condition, and it's clear to everyone how the simple task of do a ramp of stair is difficult for each member of the family.

# DAVIDE & PAOLA

2

Farmer, Cooker  
63, 58 years old



Bassano del Grappa (VI), IT

Paola and Davide are a couple who decide to open a unique business some years ago: a Bed & Breakfast in San Michele, between the hills of San Benedetto. They were both married, with two daughters who are now in the university, but now they are living together in their Bed & Breakfast. The place has a big garden with many plants, the house is surrounded by nature and Paola likes to explore it with her guests, organizing cycling or walks. The structure was an old farmer house now reconverted; it has a living area on the ground floor and the night parts with bedrooms on the second floor. The house of the couple is located at the second floor, at the same level of the guest 's bedrooms.



4 rooms b&b

140 m<sup>2</sup>

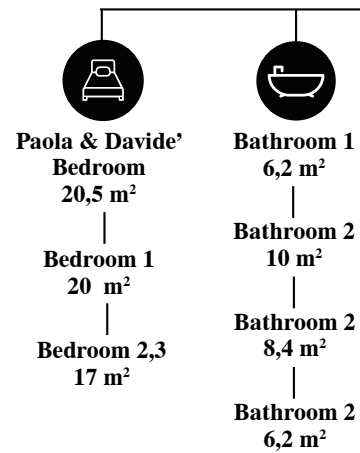

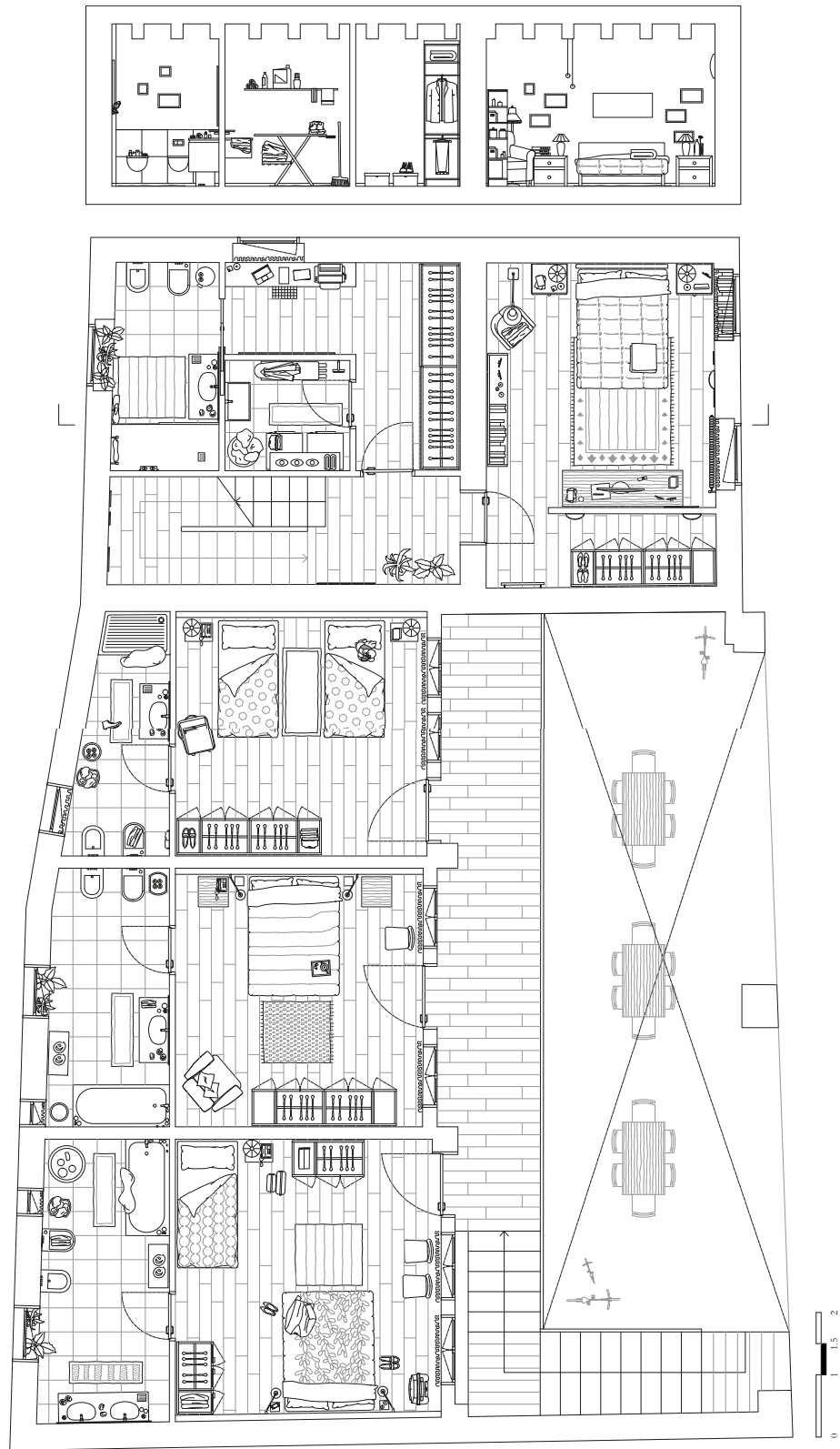

### Privacy levels



### An uncomfortable situation

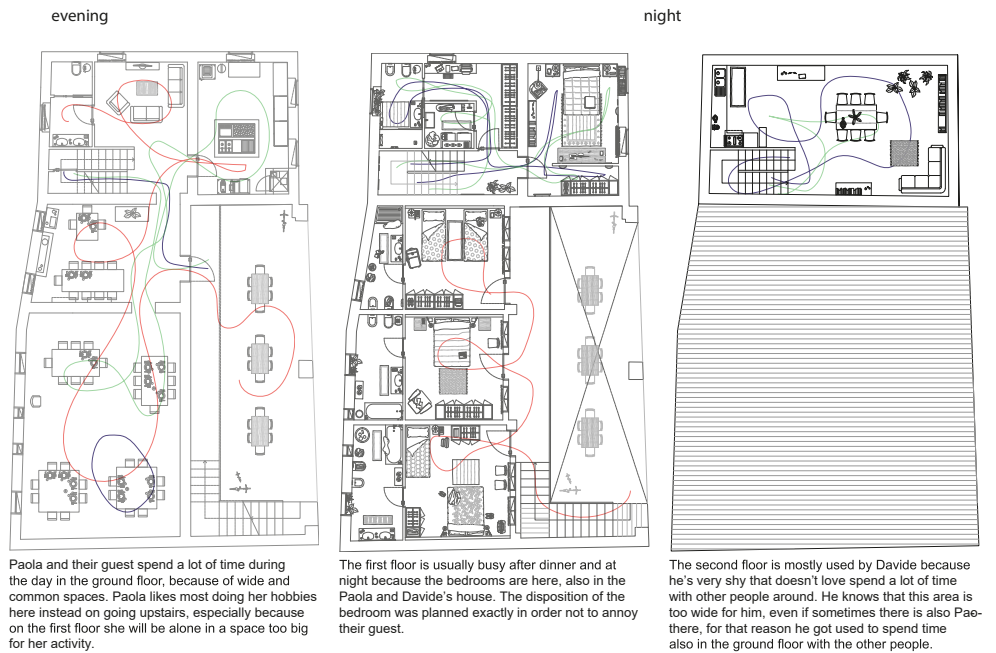

# ALESSANDRO, ELISA, RICCARDO & MARCO

Worker, worker, Student, Student  
40, 36, 7, 3 years old

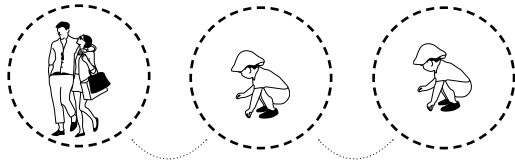

Realmonte - Modica, IT

Alessandro is an architect, he has his own office in Realmonte and consequently he lives there. Her wife and their children are living in Modica, since Elisa is working there as psychologist in a primary school. They have two children, Riccardo and Marco, who are studying in the same school where the mother works. It is hard for her to take care of the children by herself, even if as soon as he can, her husband came to visit the family in Modica during the weekend.



2 rooms apartment

60 m<sup>2</sup>

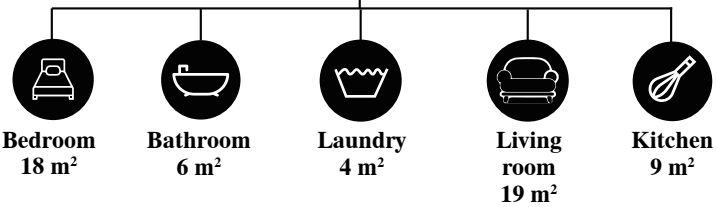

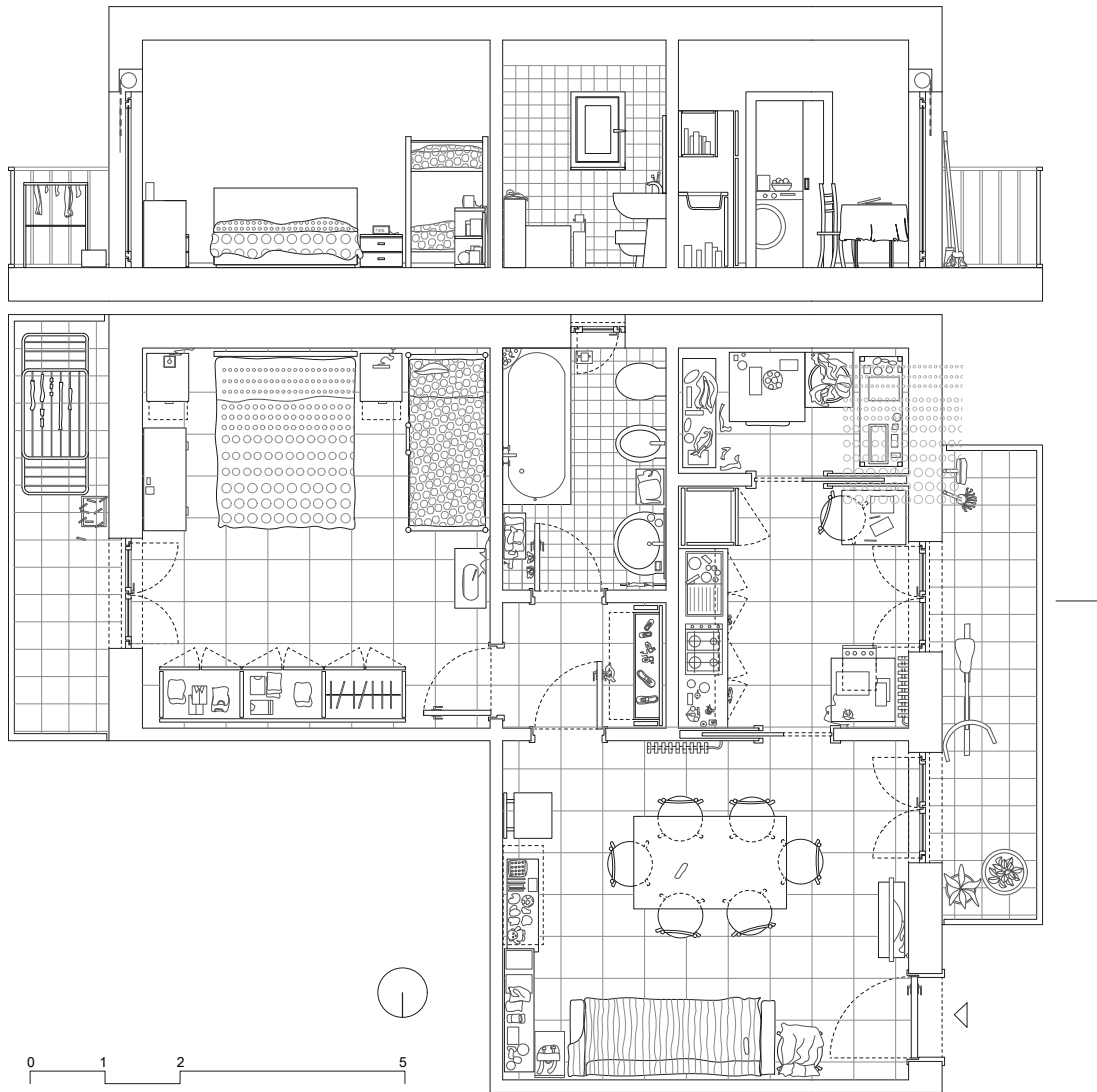

### Privacy levels

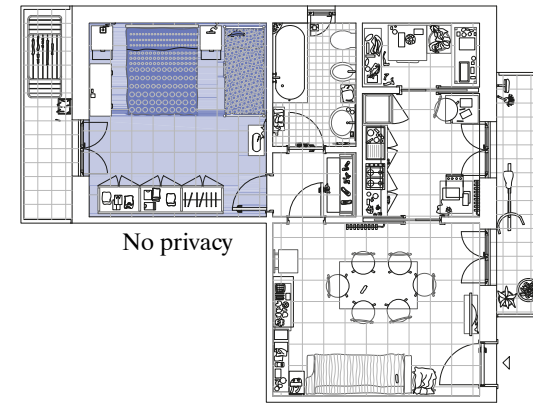

No privacy

### An uncomfortable situation

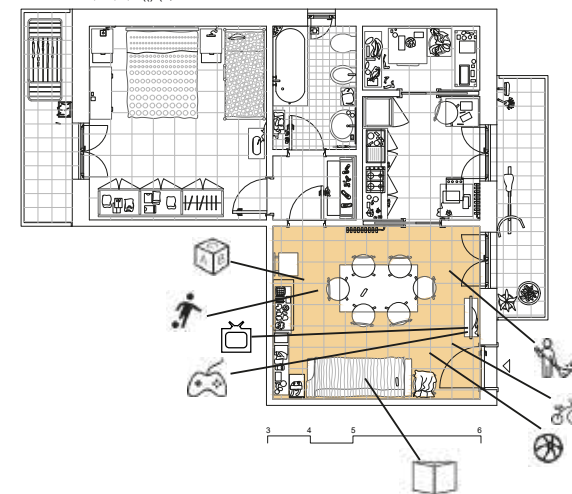

# ALESSANDRO

Worker  
40 years old



Realmonte

Alessandro is living in the old apartment of the family, which is too big for one single person, consequently many rooms are unused. He is leaving the house at 8 and he came back in in evening, the apartment is empty during the day. When he is at home he likes spend time watching tv and in the kitchen or he continue to work on his projects in the studio.



5 rooms apartment

161 m<sup>2</sup>



Master Bedroom  
21 m<sup>2</sup>  
|  
Children Bedroom  
16 m<sup>2</sup>



Bathroom  
8 m<sup>2</sup>  
|  
Bathroom  
6 m<sup>2</sup>



Studio  
15 m<sup>2</sup>



Living room  
40 m<sup>2</sup>



Kitchen  
28 m<sup>2</sup>



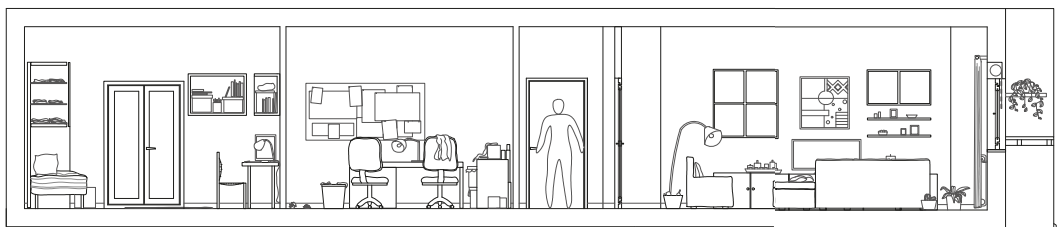
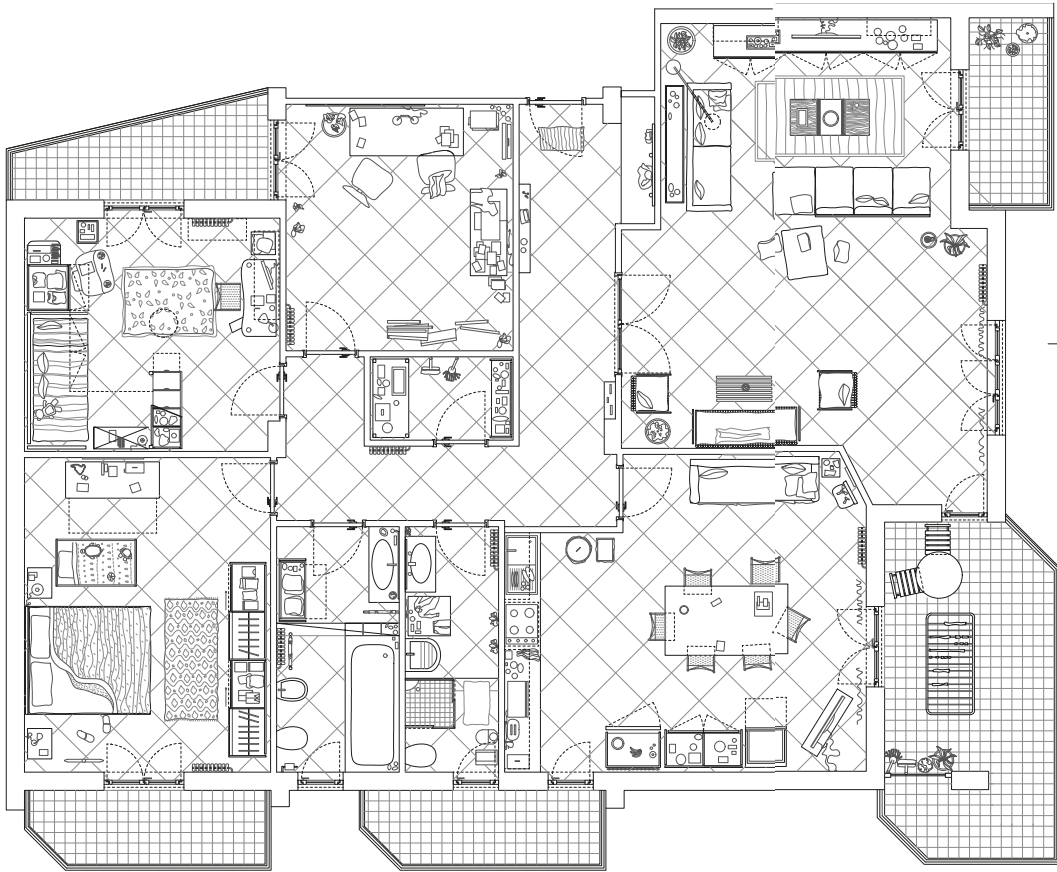

0 1 2 5



### Privacy levels

less   
 more 

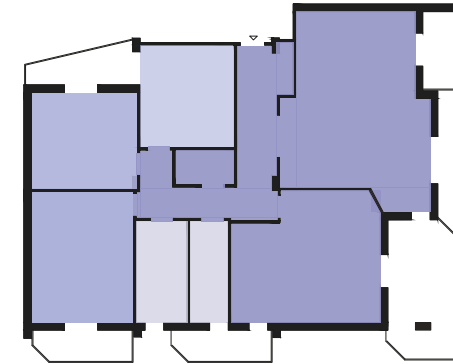

### An excess of space

less   
 more 

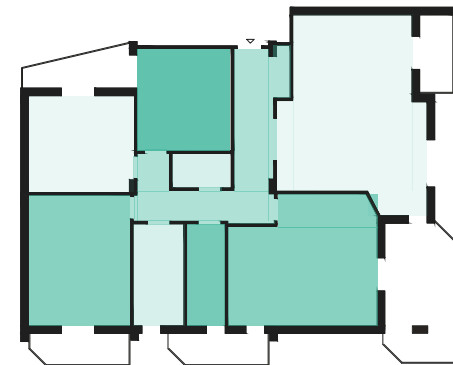

# FAMILY AND SIBLINGS

Claudio, Giovanna, Paolo, Enrico, Matteo, Chiara & Mirko, Noemi

Dr of Agriculture, Pediatrician, Student, Farmer, Student, Student & Waiter, Student

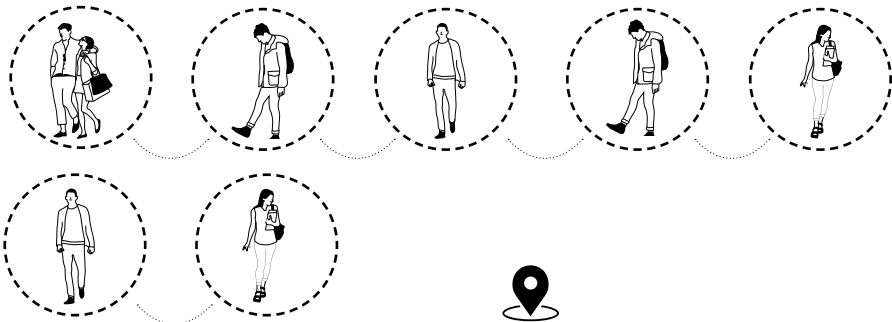

Casargo, Lecco

The family is composed by a married couple, Claudio and Giovanna, and their four blood-related sons: Paolo, Enrico, Matteo and Chiara, all of them are students except Enrico who works as a farmer. They adopt also two foster children that are brother and sister, Mirko and Noemi. Their household is set in Casargo, a town between the mountains not far from Lecco. They also have a house in Lecco where Paolo and Enrico are living, even if Enrico is not working in Lecco and Paolo is studying in Milan. The other children are going to the high school in Lecco everyday by bus.



**Casargo**  
4 rooms apartment  
72,5 m<sup>2</sup>

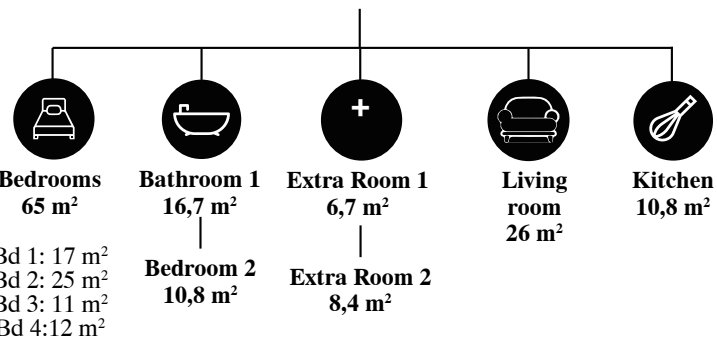



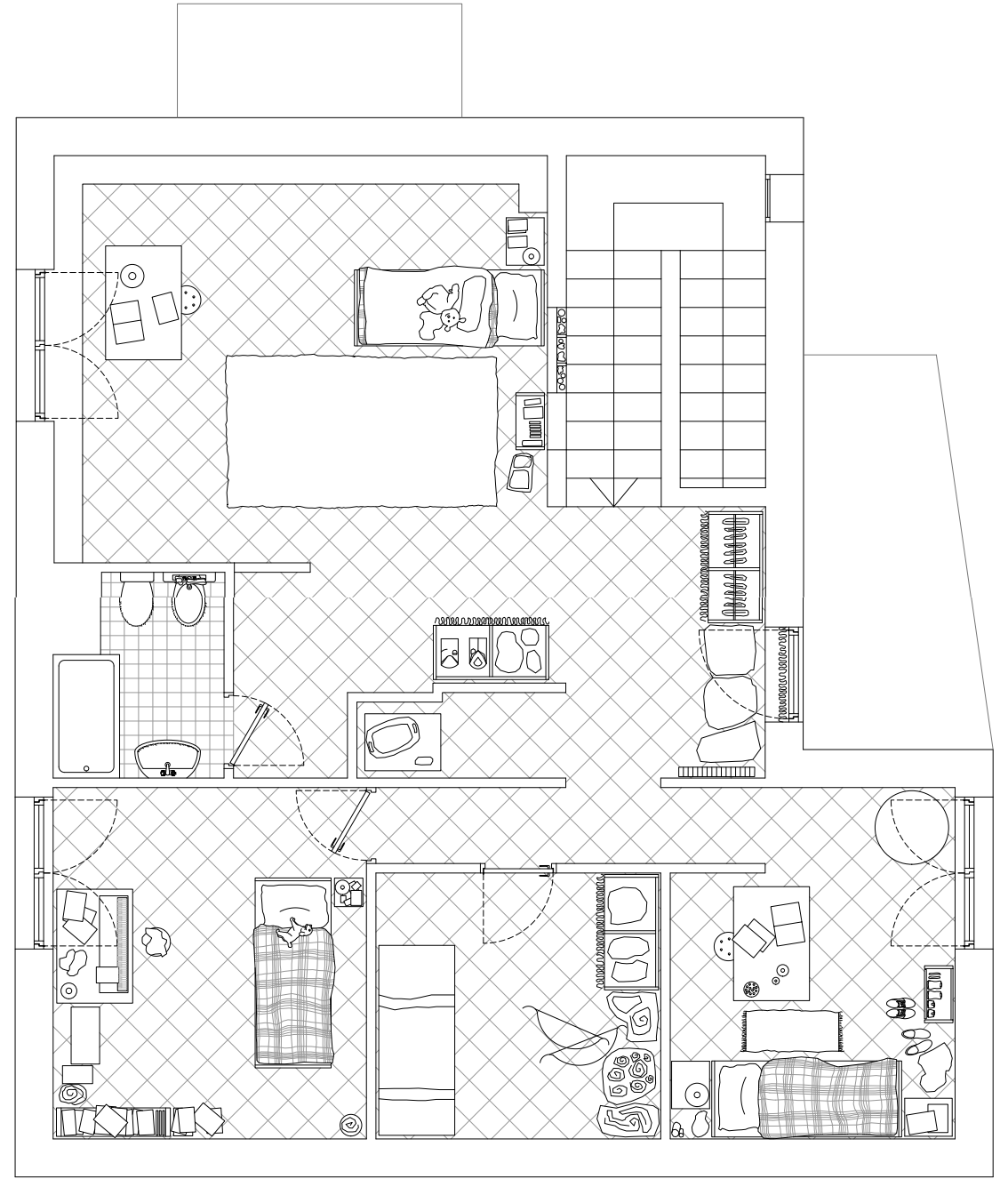
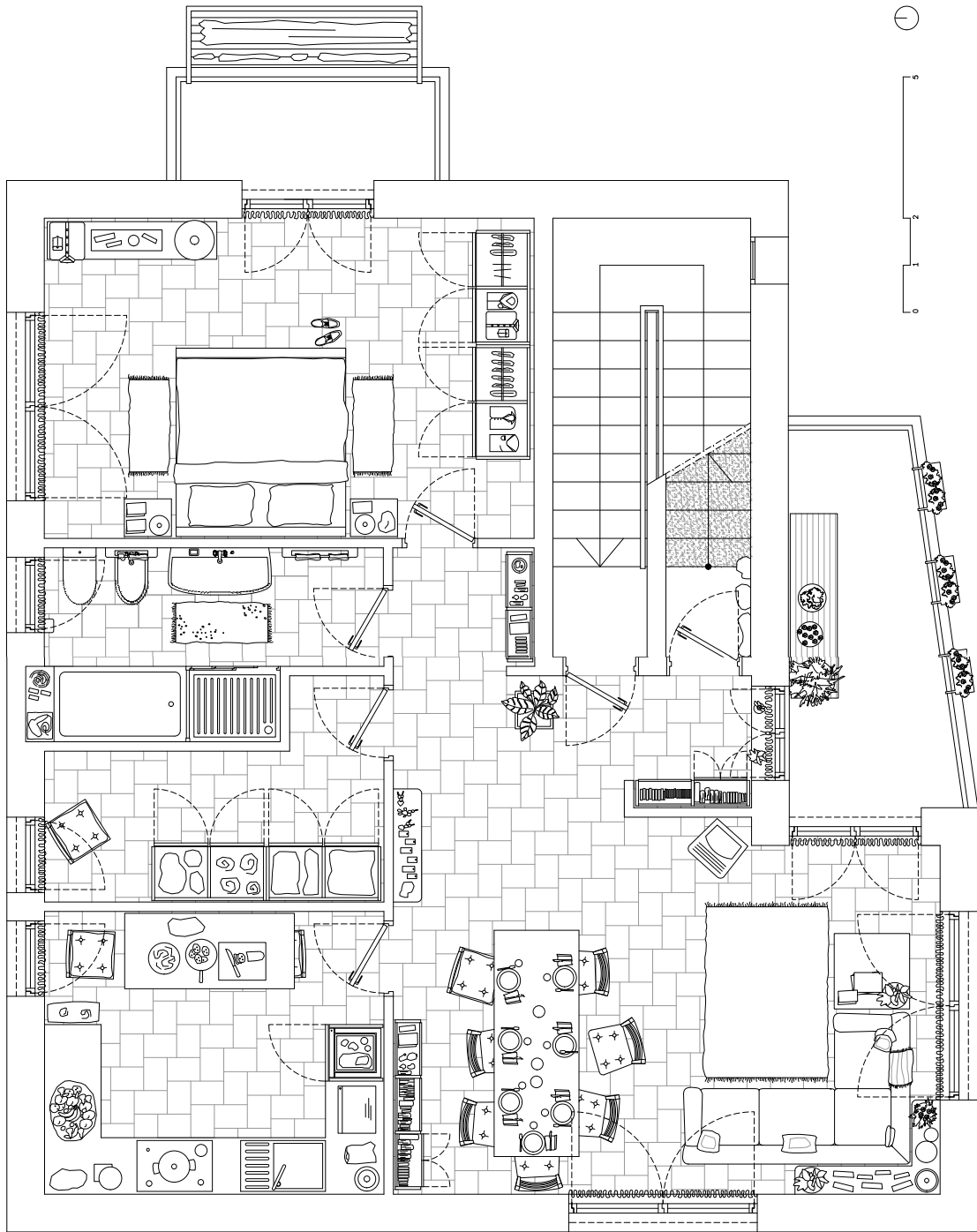

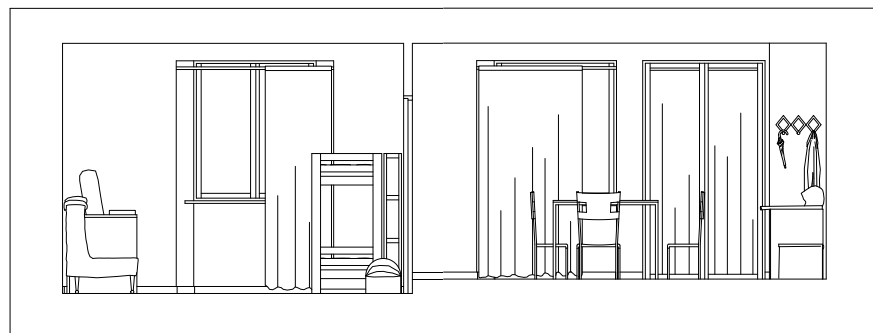
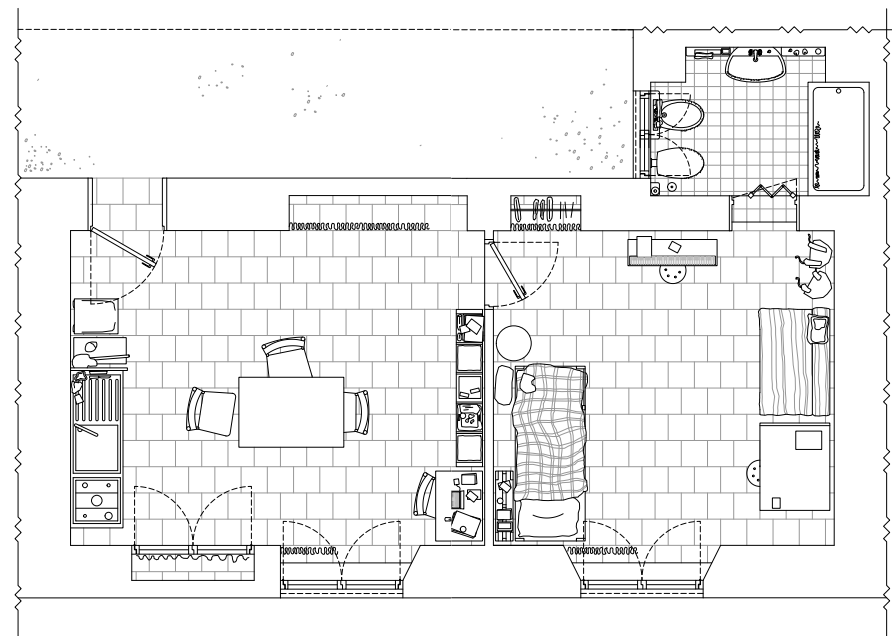

**Lecco**  
**2 rooms apartment**  
**37 m<sup>2</sup>**



**Bedroom**  
**14 m<sup>2</sup>**



**Bathroom**  
**5 m<sup>2</sup>**



**Living room + kitchen**  
**18 m<sup>2</sup>**



**Privacy levels**

- No privacy
- Yes privacy

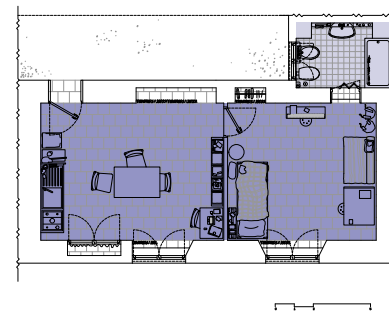

**Usage of space**

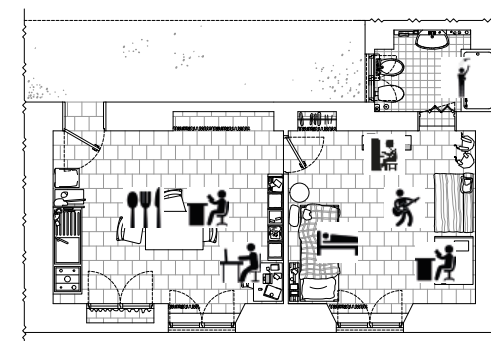

# GIOVANNI & BEATRICE

5

Student & Student  
24 & 19 years old

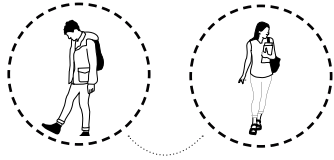

Milan, IT

Giovanni and Beatrice are off-site students, they are living in Sesto San Giovanni since they started the university. Giovanni is studying architecture, he is at his third year of bachelor, while Beatrice is in her first year of biotechnology engineer. Both of them are studying in Politecnico. They are living in a bi-local apartment and they are sharing the bedroom. Before Giovanni was living with Beatrice's sister, who took over after she finished her studies. Their cohabitation is good, Giovanni is spending most of his time in the kitchen, while Beatrice in the bedroom.



2 rooms apartment  
39,5 m<sup>2</sup>



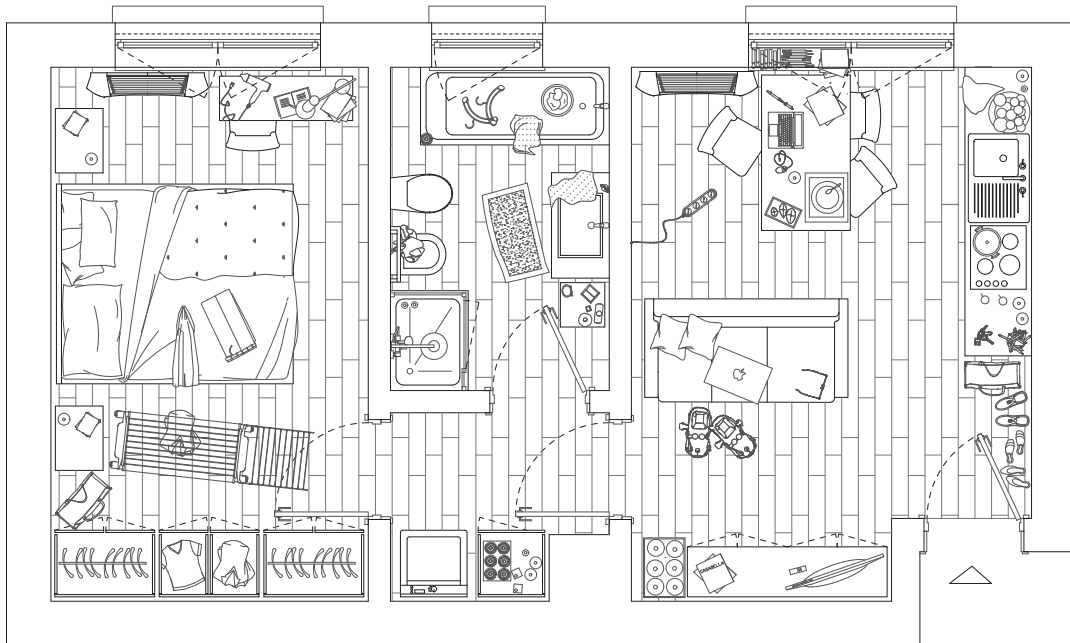

### Privacy levels



### Usage of space

#### Conflict space

Beatrice and Giovanni have created a private space in the common areas but one at the expense of the other

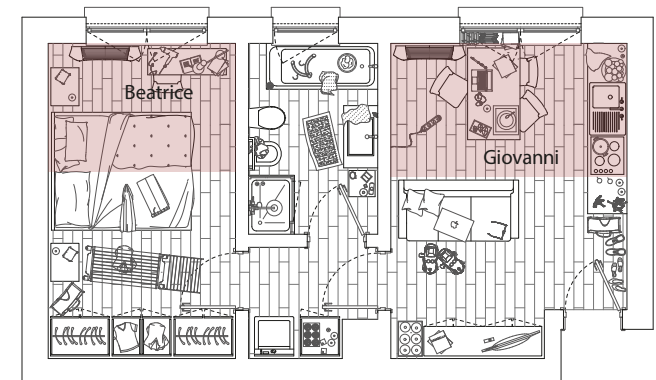

## AN UN-COMFORTABLE LIVING

The practices of “Re.Co.De 2018” offer a wide panoramic about the contemporary housing situation: most of the cases studies are examples of co-living between **intergenerational people often not blood-related**. They take place in **standard apartment** designed for traditional families, which do not help the creation of an harmonic space to live between not blood-related people.

The shared and private space are **not adequate to a co-living situation**: each inhabitant is not able to have his own private space and the shared area is not designed as a collective space to interact and share; these considerations emerged not only from the drawing but also interviewing the people themselves. The **shared space** does not provide services proportionate to the residents’ number and needs, the bathroom, the kitchen and the living room are in order the rooms who generate the stronger argument inside the house. In the **bathroom** residents may have the same time-table and there will be the necessity of using it at the same time; moreover, it is an intimate room, so sharing between strangers will not be easy for everyone. **Kitchen** is the second place in a house that can generate conflicts: the need of cooking at the same time, the cleaning, the small spaces and the presence of one cooker may affect the harmony inside the house. The **living room** may generate problems: one living room is not enough for the residents who may wants to use it for different purpose, like invite friends over, relax on the sofa or watch a movie, these are all activities that can not be done in the same space. At the same time the **private space** does not offer a sufficient level of privacy for everyone: not all the individuals are able to have a personal room, while if they have, they might not be present a personal bathroom, a small personal living space is almost impossible to find, unless in cases of new built villas with many rooms. The personal space deeply influencing the people lifestyle: if someone is working from home, it might be necessary for him working outside; if someone studies subject that requires the presence of a big table or a big space it is impossible to do it at home. Moreover, the private space is not design as it is the only personal and intimate area of the resident, but simply as a bedroom, which will not guarantee space for private activities.

In conclusion it must be highlight the **main consideration** we learn from the practices, which will be able to help the definition of a co-living project and understand the phenomenon of the co-habitation:

- 1. Defining nuclei not numbers.** It is not enough to consider the inhabitants counting their number for designing the space, but it must be counted the number of families inside, so the “nuclei”. Nuclei is the minimum family unit, it can be one person, a couple, a traditional family.. each nuclei are independent one to another and they consequently need a proportionate private space for their member and a collective one for them.
- 2. Bedroom is not only the bed.** Each resident has his personal activi-

ties to do and in a situation of co-habitation, not all the activities can be done in the shared space. For this reason, the bedroom can not be conceived as a room with only the bed, the bedroom is the only private space for the resident so it must become a bedroom, a living room and a study room.

**3. A room for the guests.** Guests or people staying half of the week need their privacy as well, each of them should have an extra room that can guarantee their privacy from the rest of the family or the residents of the house.

**4. Bathroom should be private.** The bathroom is the room that generate most of the conflicts, for this reason each nucleo should have their own bathroom; inside the same nucleo, there will be the necessity of having an extra bathroom, for instance in case of an adult son or two adult blood related living together.

**5. Shared area as space of interaction, not conflicts.** Kitchen and living area are also spaces that can generate conflicts, for this reason they should be proportional to the number of people living inside, in terms of number of furniture and size of the space. There should be also more than a single living room since the living area is composed by the space that connect all the rooms and that give the possibility of doing different activities.



