

# TAVOLA 3 - IL PROGETTO: L'APPROFONDIMENTO CULTURALE



TEMATICA COMUNE:  
"SCARTO O RISORSA?"

ENERGIE SOSTENIBILI



CASCINA PALLAVICINA

TECNOLOGIE IN AGRICOLTURA



CASCINA DOTTI

AMBIENTE



CASCINA MONACHE

ABITUDINI ALIMENTARI



CASCINA SOMASCA

## LE MOSTRE FOTOGRAFICHE DEI FOTOGRAFI PROFESSIONISTI

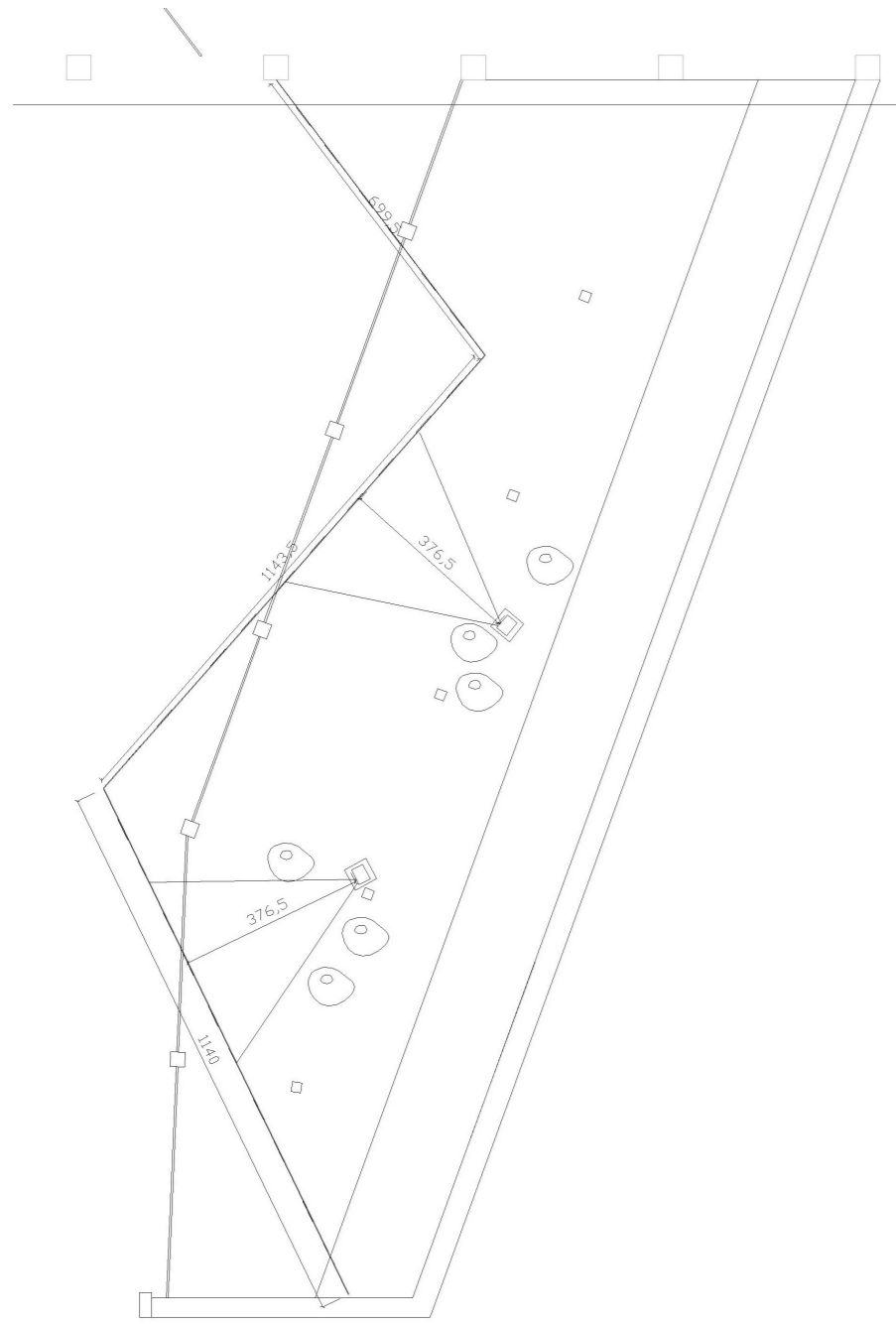

scala 1 : 100

Lato dell'esposizione delle opere dei fotografi professionisti

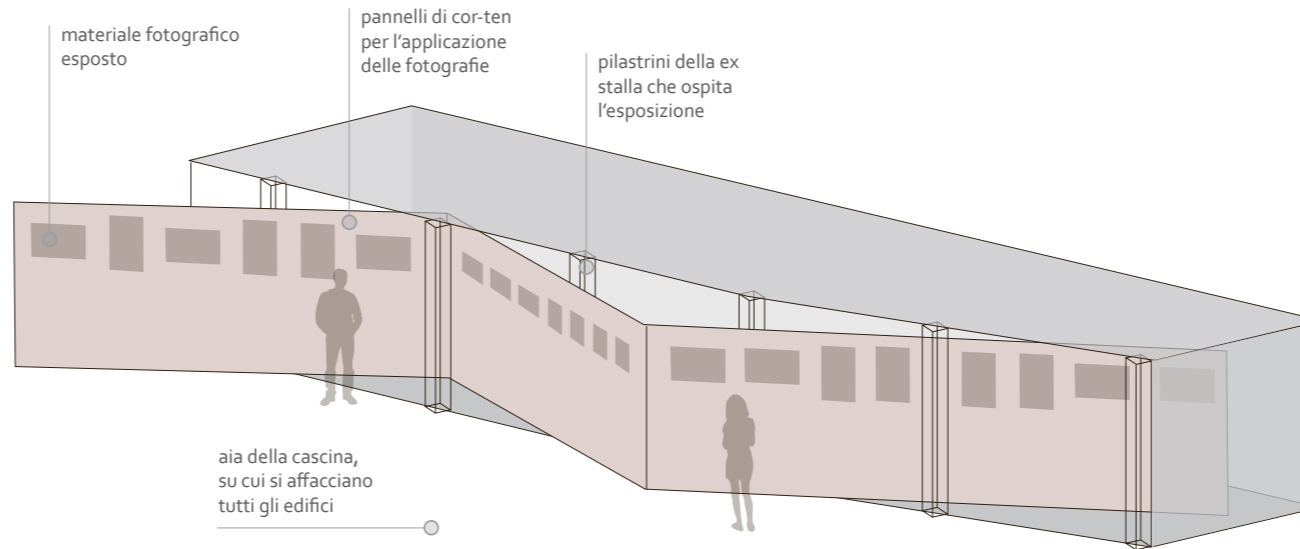

Lato delle proiezioni sul fotografo protagonista dell'esposizione

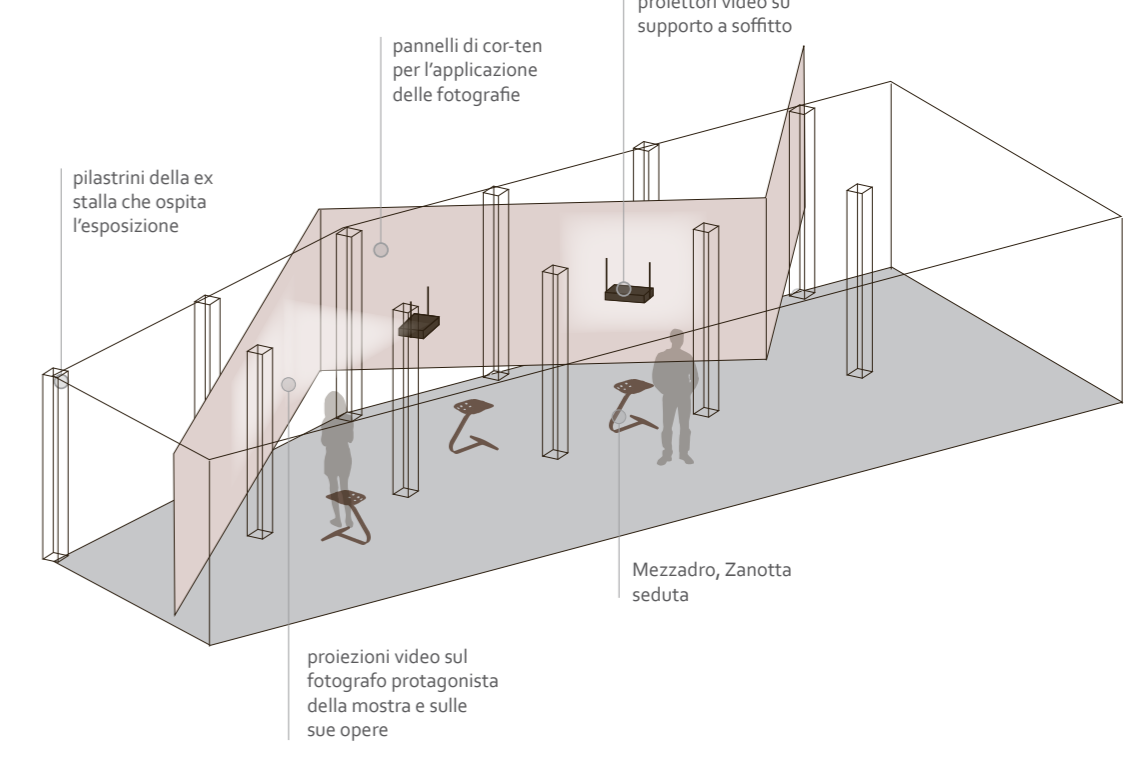

## LA SALA DEL CONCORSO FOTOGRAFICO APERTO AL PUBBLICO

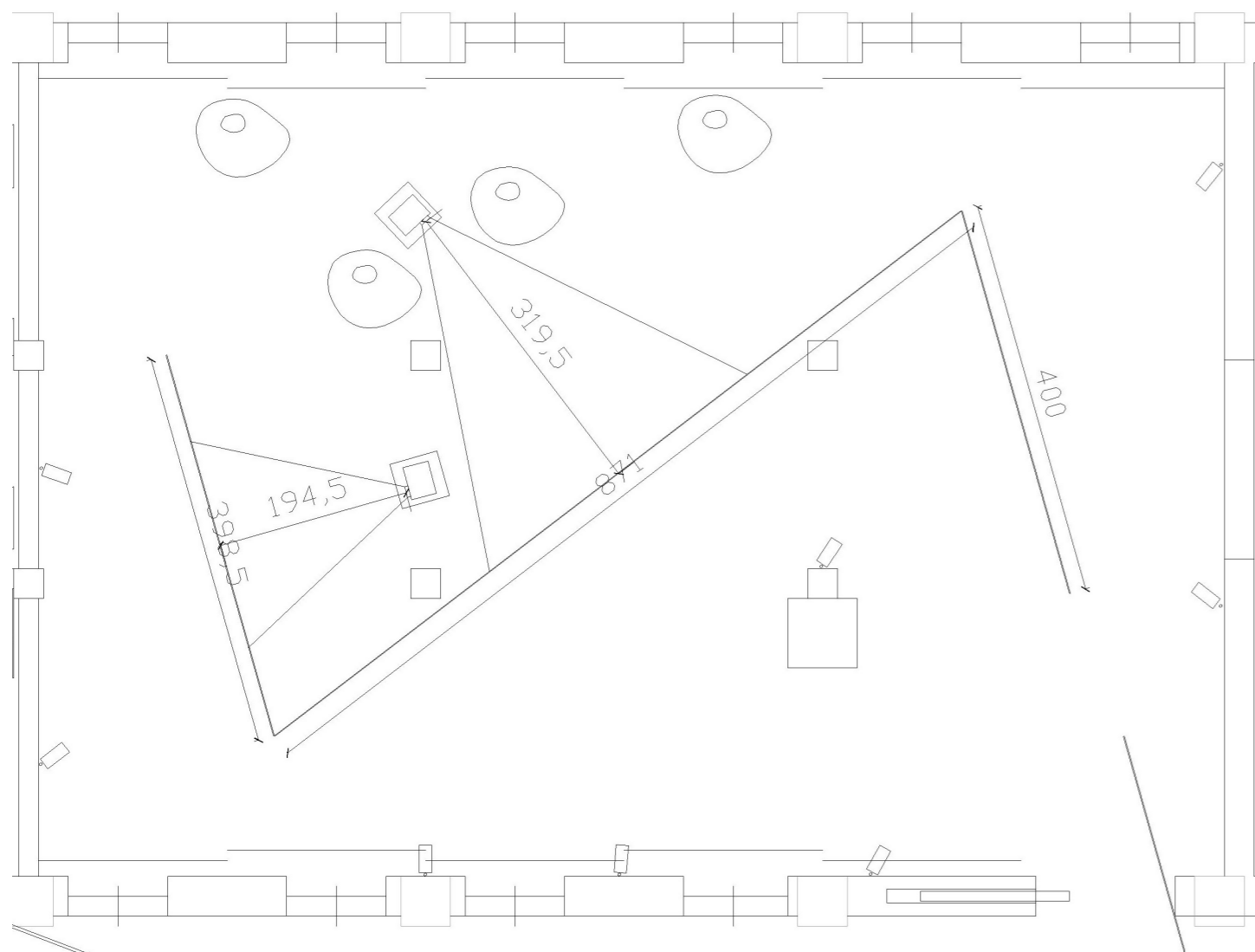

scala 1 : 100

Lato dell'esposizione fotografica della sala del concorso

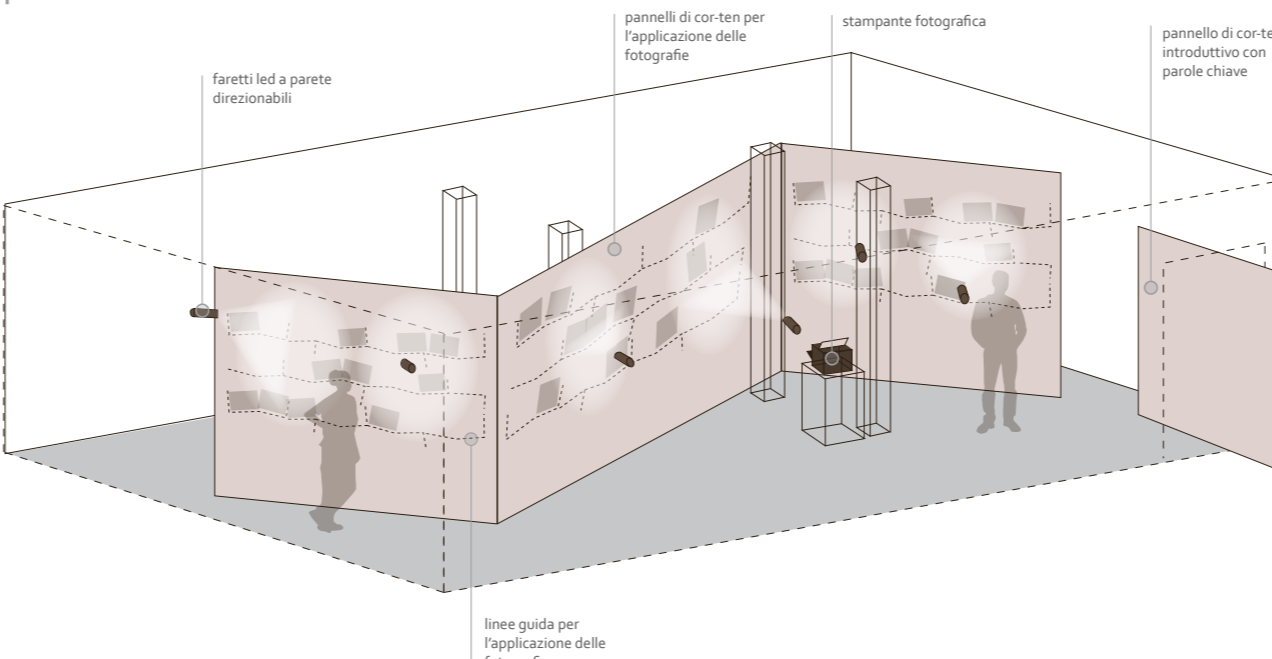

Lato delle proiezioni della sala del concorso

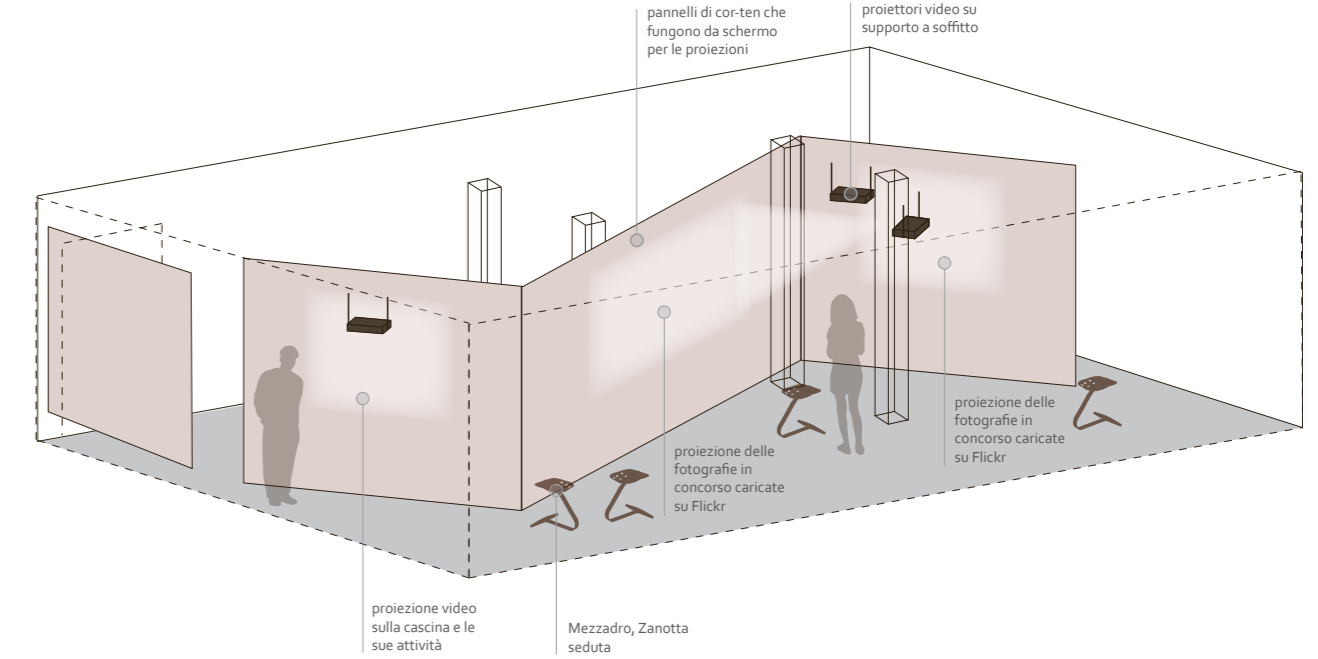

## LA COMUNICAZIONE - VIATERRA

Pannello di introduzione alla cascina

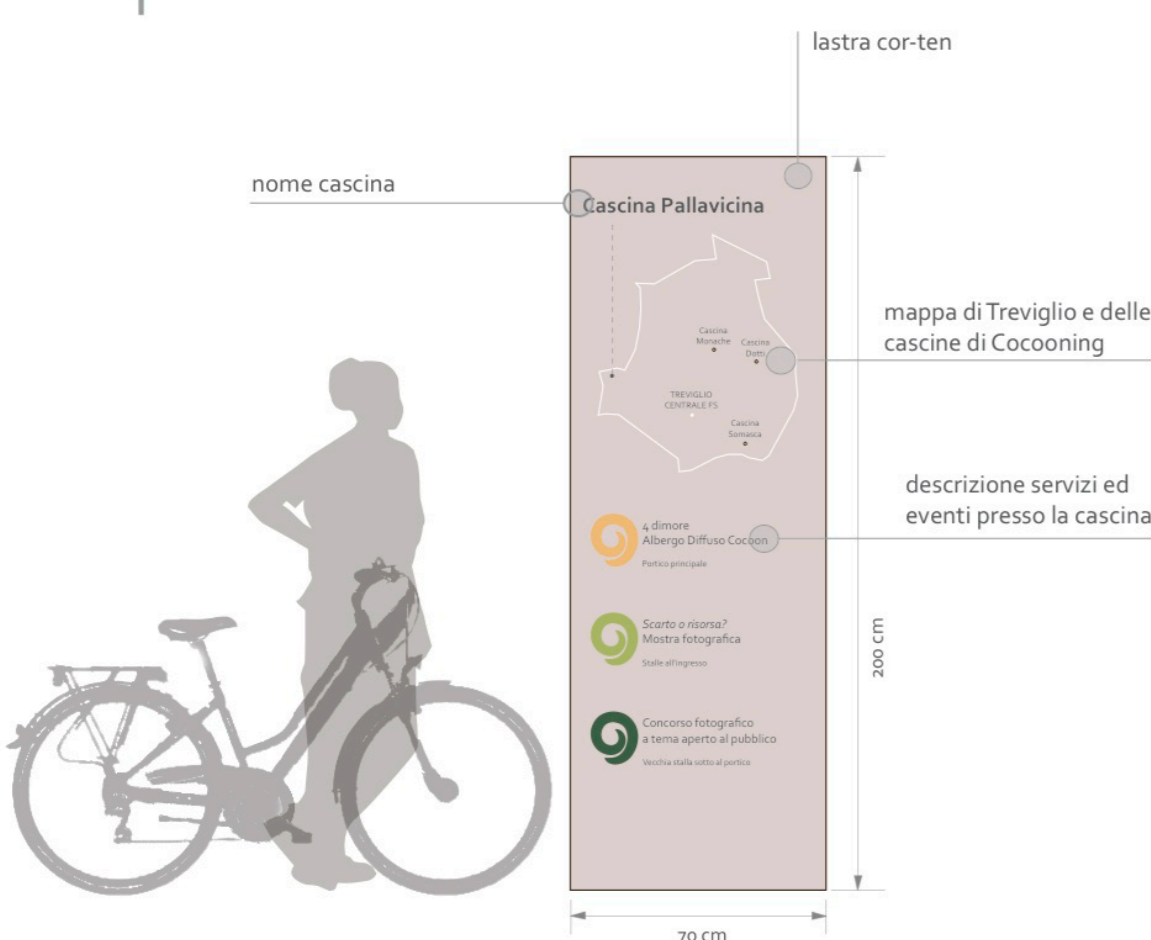

Pannello di presentazione di Cocooning a Rho

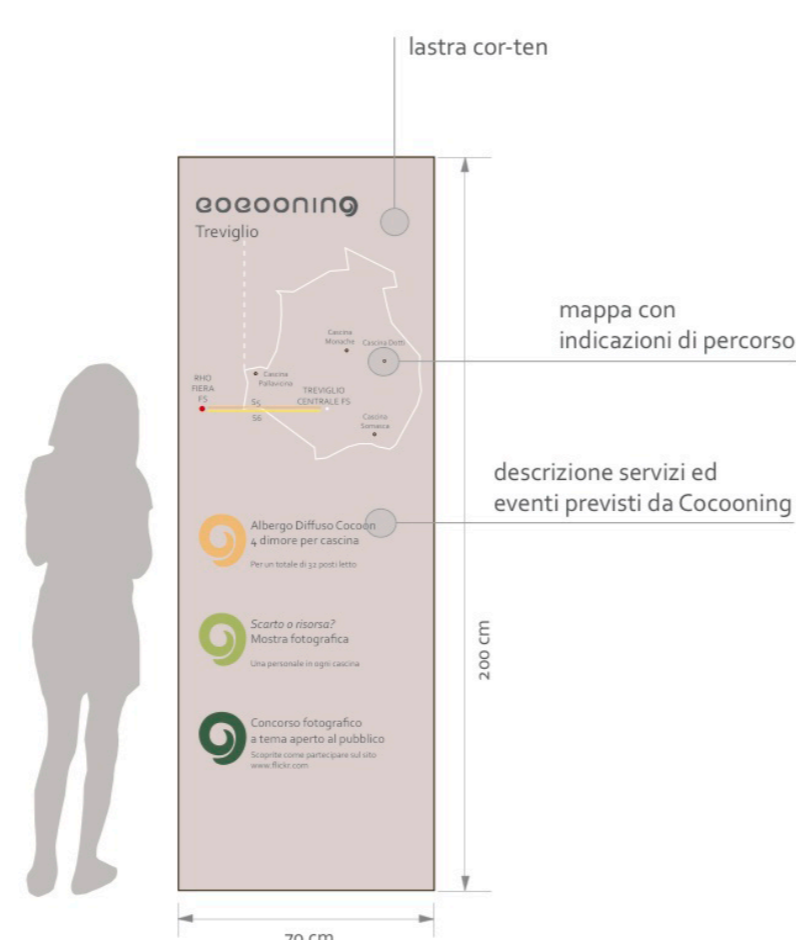

Pannello da applicare nelle stazioni delle linee S5 e S6

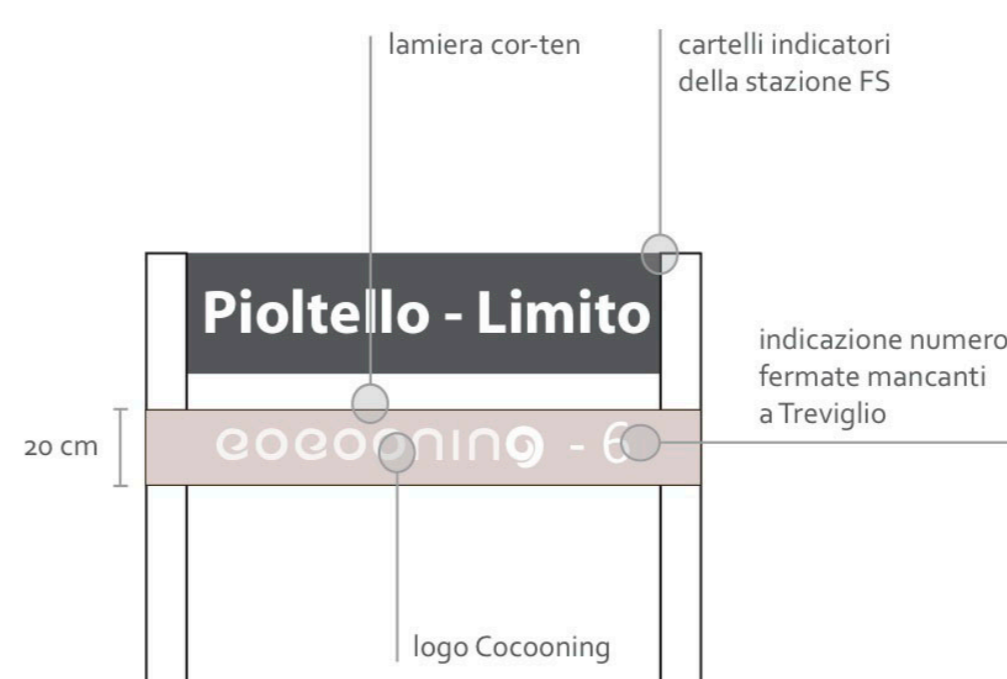

VIA WEB

