

SCHEMA MONTAGGIO

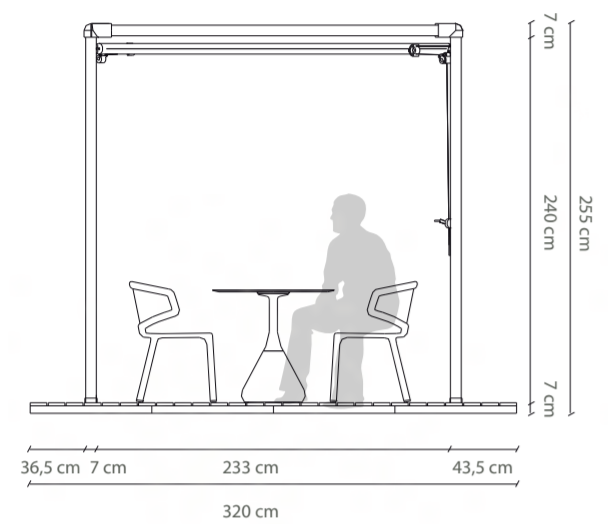

MODULO
scala 1:50

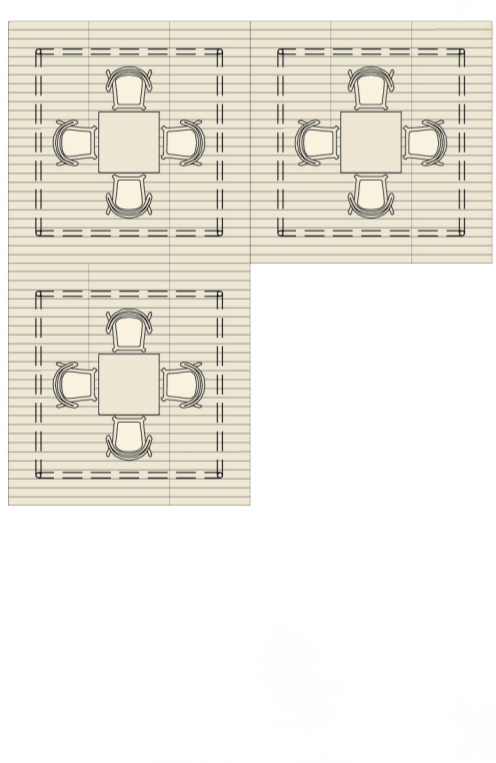

PIANTA AREA BAR
scala 1:100

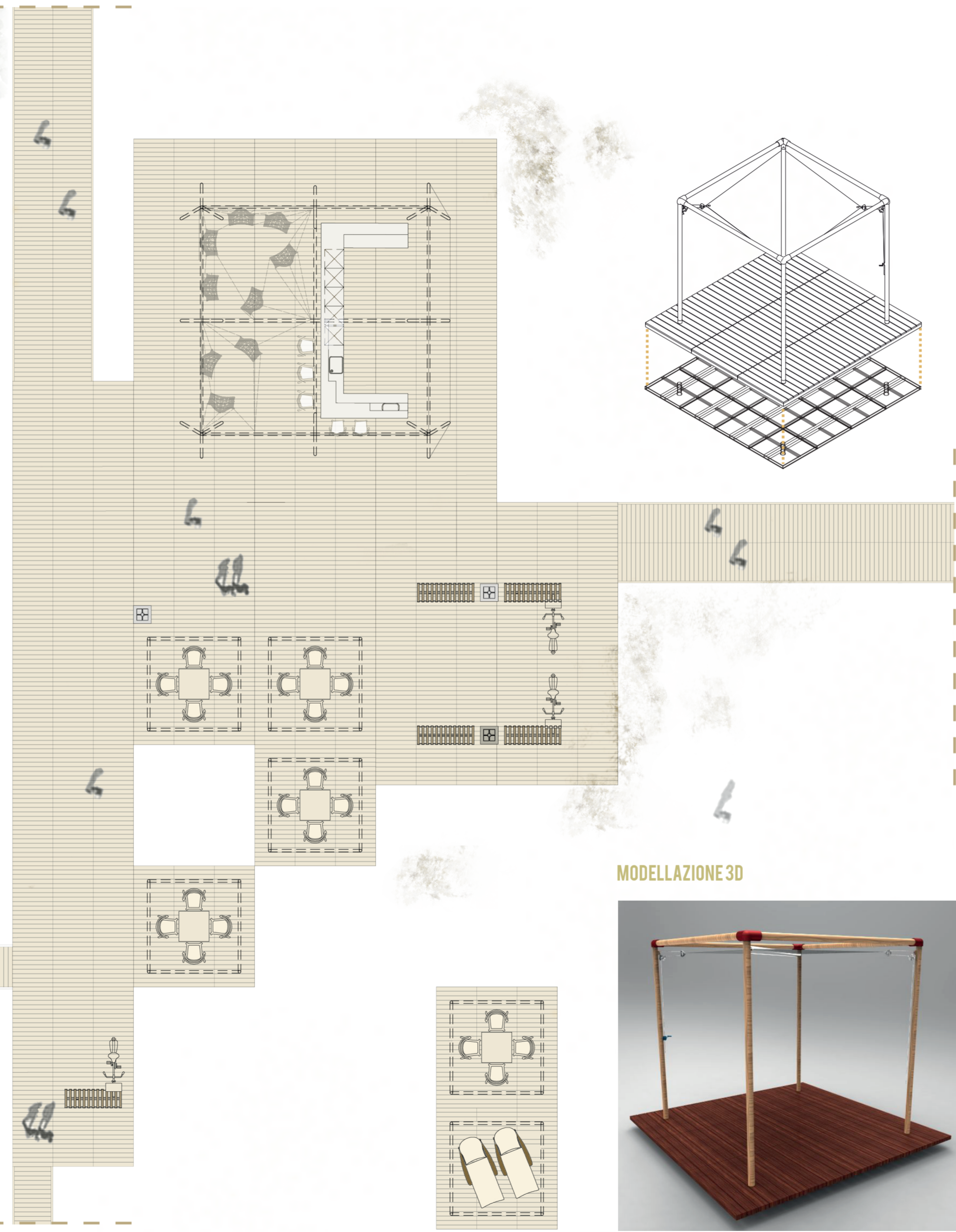
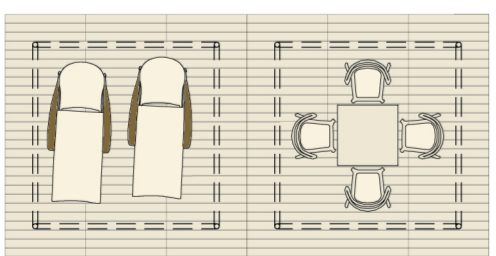

MODELLAZIONE 3D

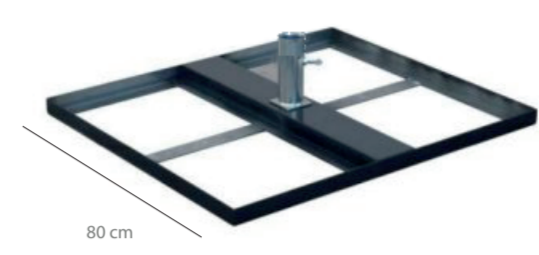
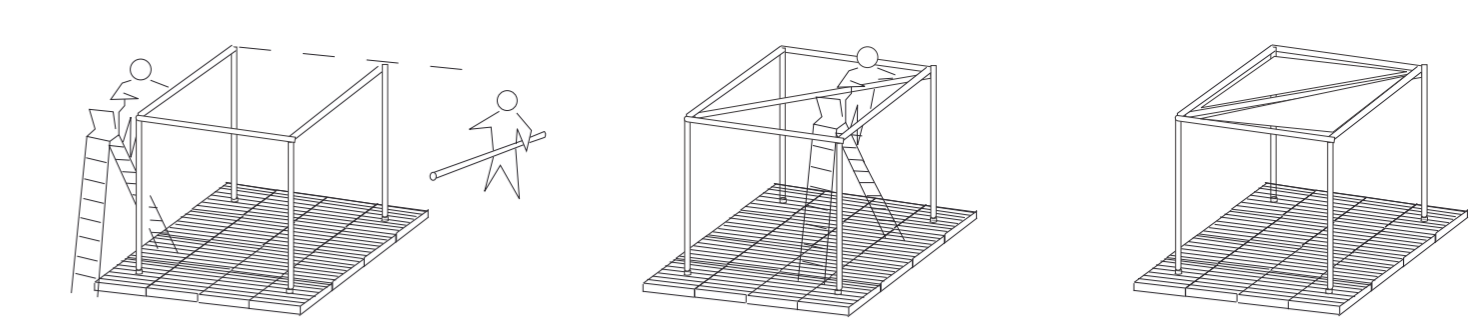

BASE DI SUPPORTO

Matrice di supporto inferiore in acciaio zincato _ c.a 14 Kg (alloggio pali e sostegno pedana)



MODULO PEDANA

Pannelli composti da doghe antisdrucolo traversi in alluminio per collegamento maschio-femmina dim. 1065 x 1065 mm

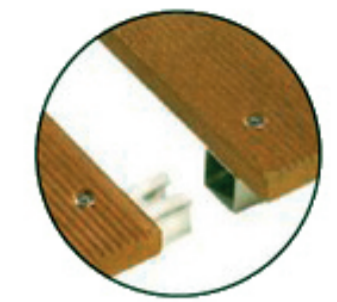

SISTEMA DI OMBREGGIAMENTO

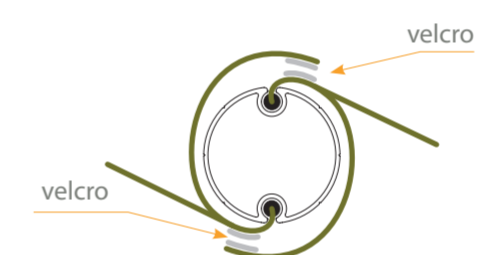
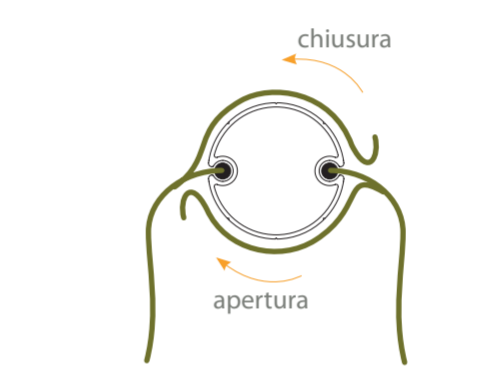

2 vele avvolgibili su un profilo in Alluminio anodizzato Ø 6,5 cm

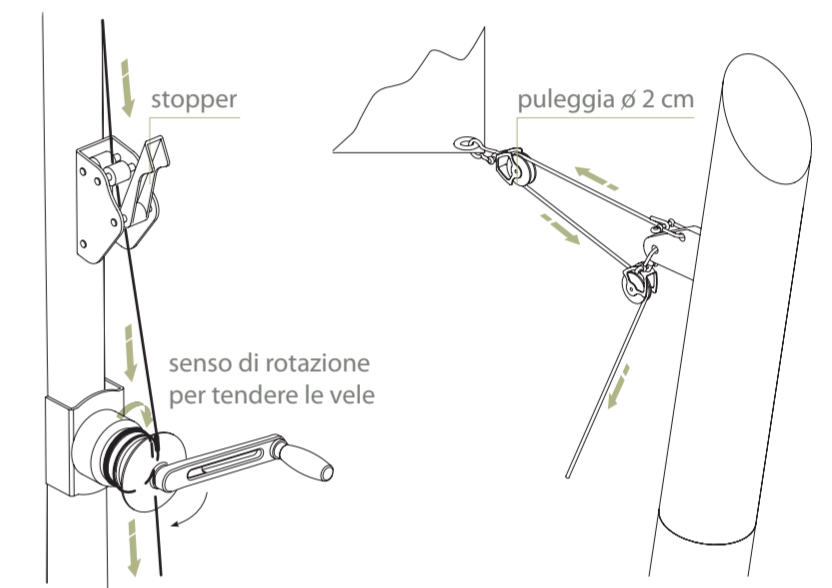
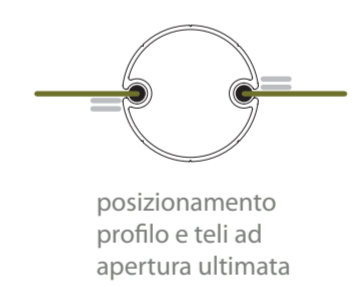

FOTOINSERIMENTO LUNGO L'ARENILE

