

Specimen 1 - n°: 9

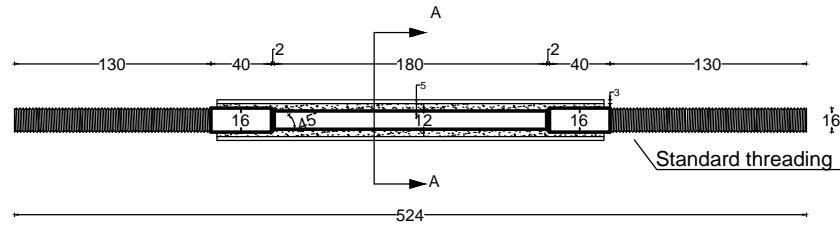

Section A-A



Specimen 2 - n°: 9

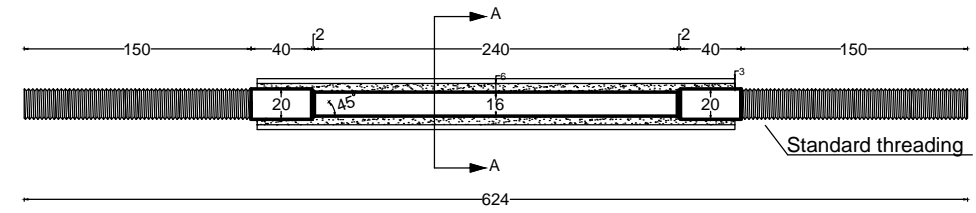

Section A-A



Specimen 3 - n°: 9

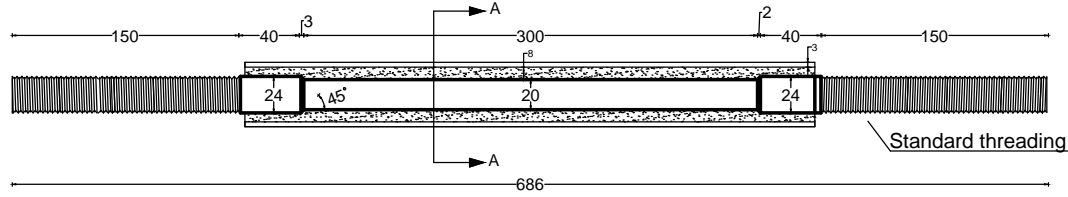

Section A-A



Specimen 4 - n°: 9

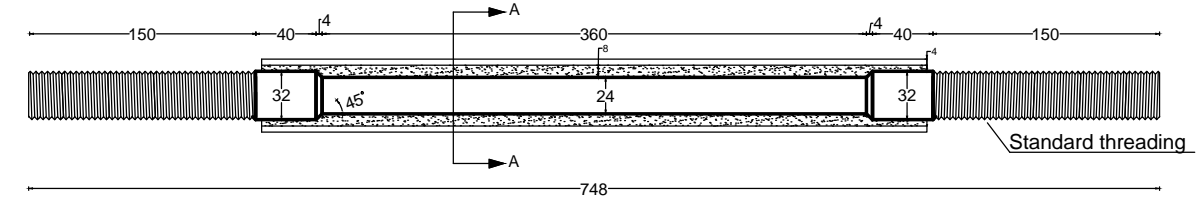

Section A-A



Specimen 5 - n°: 9

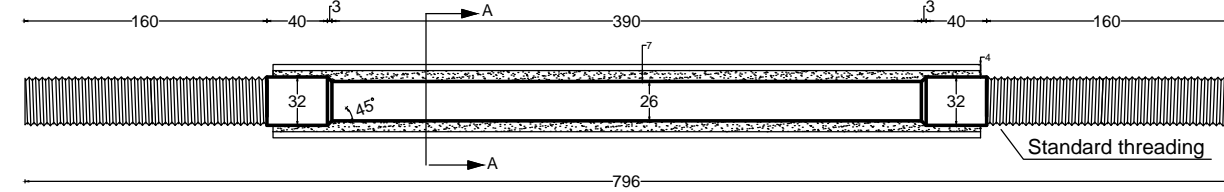

Section A-A



Specimen 6 - n°: 3

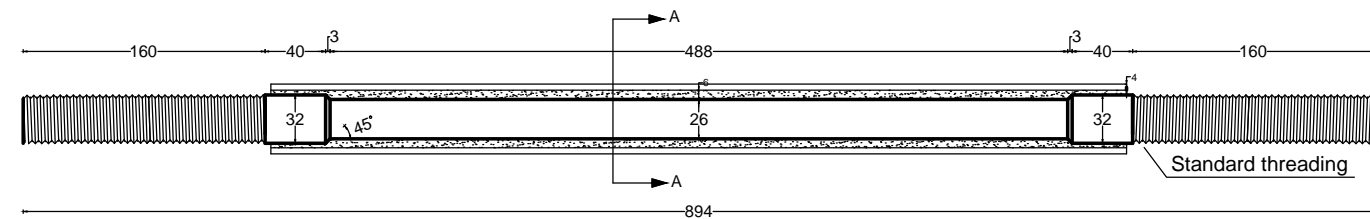

Section A-A



Specimen 7 - n°: 3

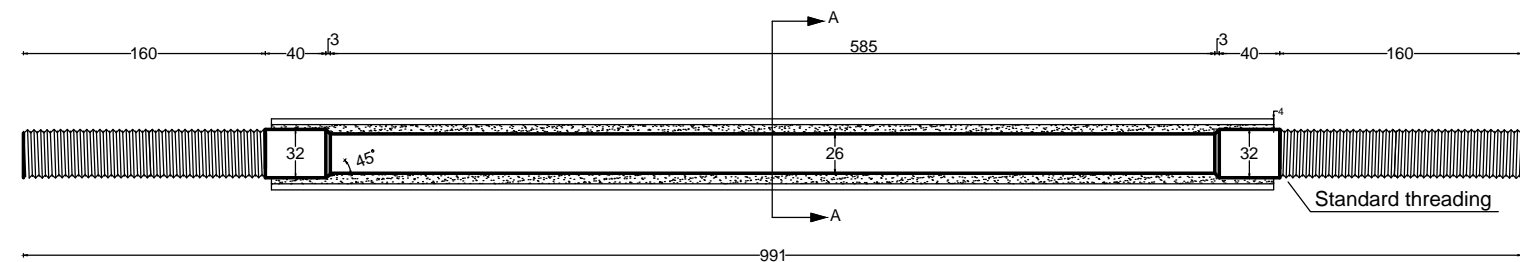

Section A-A

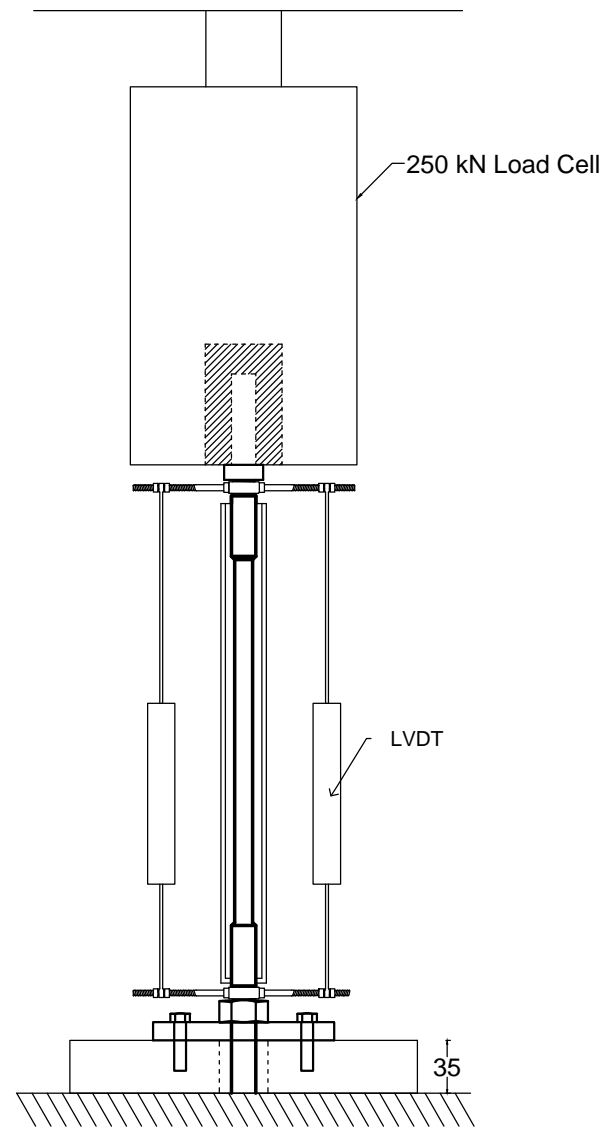

Tav. 2: Test Set up and Details of External Dissipator Devices to be Tested

Scale: 1:10