

Vision System FH-Series

Easier to Embed in Machine, Shorter Machine Cycle Times

- Calculations are easy to set for the results from four parallel tasks.
- Synchronous control of devices connected via EtherCAT is possible.
- The new Shape Search III processing item enables fast, precise, and stable measurements.
- Microsoft® .NET is supported to share machine interface with PC.
- User interface customization is supported.



System configuration

EtherCAT connections for FH series

Example of the FH Sensor Controllers (4-camera type)

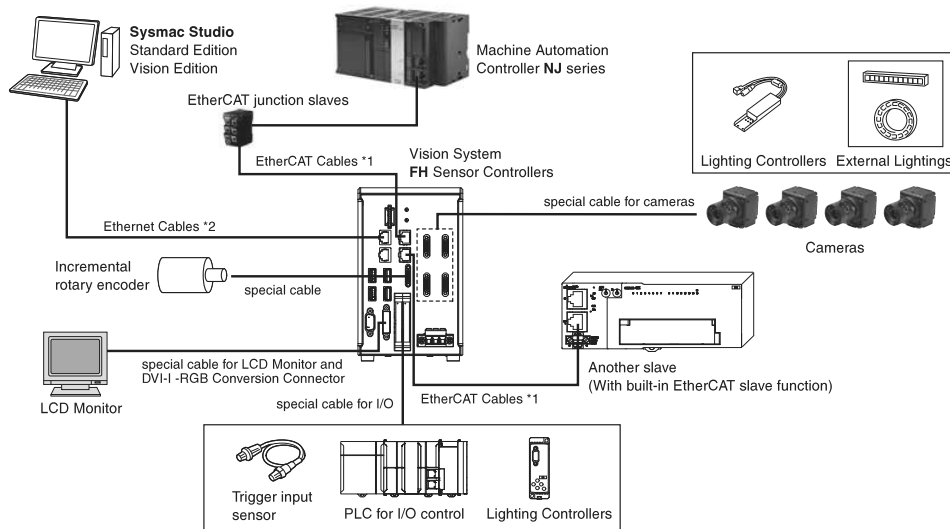

*1. To use STP (shielded twisted-pair) cable of category 5 or higher with double shielding (braiding and aluminum foil tape) for EtherCAT and RJ45 connector.
*2. To use STP (shielded twisted-pair) cable of category 5 or higher for Ethernet and RJ45 connector.

EtherNet/IP, No-protocol Ethernet and PLC Link Connections for FZ5 series

Example of the FZ5 Sensor Controllers (4-camera type)

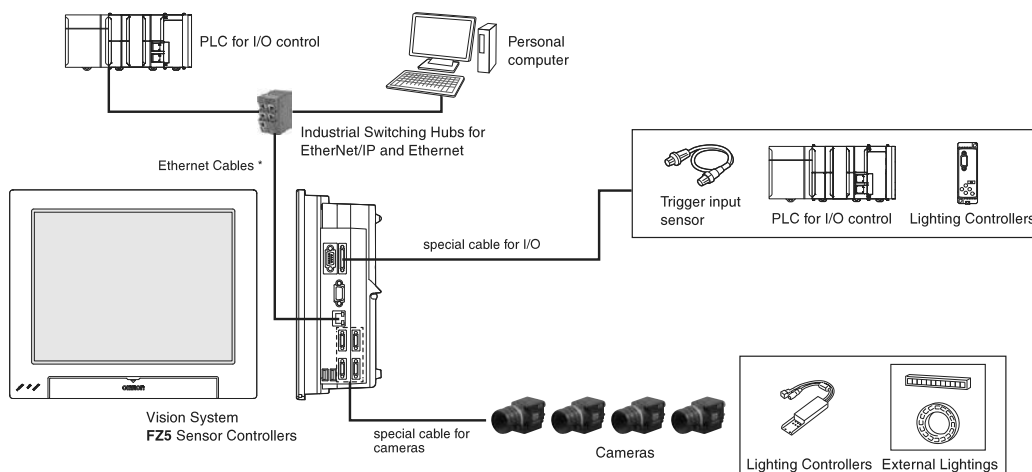



* To use Straight or cross STP (shielded twisted-pair) cable of category 5 or higher for Ethernet and RJ45 connector.

Ordering Information









FH Series Sensor Controllers

Item	CPU	No. of cameras	Output	Model
 Box-type controllers	High-speed Controllers (4 core)	2	NPN/PNP	FH-3050
		4	NPN/PNP	FH-3050-10
		8	NPN/PNP	FH-3050-20
	Standard Controllers (2 core)	2	NPN/PNP	FH-1050
		4	NPN/PNP	FH-1050-10
		8	NPN/PNP	FH-1050-20

FZ5 Series Sensor Controllers

Item	CPU	No. of cameras	Output	Model
 Controllers integrated with LCD	High-speed Controllers	2	NPN	FZ5-1100
			PNP	FZ5-1105
		4	NPN	FZ5-1100-10
			PNP	FZ5-1105-10
	Standard Controllers	2	NPN	FZ5-600
			PNP	FZ5-605
4		NPN	FZ5-600-10	
		PNP	FZ5-605-10	
 Box-type controllers	Lite Controllers	2	NPN	FZ5-L350
			PNP	FZ5-L355
		4	NPN	FZ5-L350-10
			PNP	FZ5-L355-10

Cameras

Item	Descriptions	Color / Monochrome	Image read time	Model
 High-speed CMOS Cameras (Lens required) For FH Sensor Controllers only	12 million pixels (Up to four cameras can be connected to one Controller. Up to eight cameras other than 12 million-pixel cameras can be connected to a FH-3050-20 or a FH-1050-20.)	Color	25.7 ms *	FH-SC12
		Monochrome		FH-SM12
 High-speed CMOS Cameras (Lens required) For FH Sensor Controllers only	4 million pixels	Color	8.5 ms *	FH-SC04
		Monochrome		FH-SM04
	2 million pixels	Color	4.6 ms *	FH-SC02
		Monochrome		FH-SM02
 High-speed CMOS Cameras (Lens required) For FH Sensor Controllers only	300,000 pixels	Color	3.3 ms *	FH-SC
		Monochrome		FH-SM
 Digital CCD Cameras (Lens required)	5 million pixels (When connecting FZ5-6□ or FZ5-L35□, up to two cameras can be connected.)	Color	62.5 ms	FZ-SC5M2
		Monochrome		FZ-S5M2
 Digital CCD Cameras (Lens required)	2 million pixels	Color	33.3 ms	FZ-SC2M
		Monochrome		FZ-S2M
	300,000 pixels	Color	12.5 ms	FZ-SC
		Monochrome		FZ-S
 High-speed CCD Cameras (Lens required)	300,000 pixels	Color	4.9 ms	FZ-SHC
		Monochrome		FZ-SH
 Small Digital CCD Cameras (Lenses for small camera required)	300,000-pixel flat type	Color	12.5 ms	FZ-SFC
		Monochrome		FZ-SF
	300,000-pixel pen type	Color	12.5 ms	FZ-SPC
		Monochrome		FZ-SP
 Intelligent Compact CMOS Cameras (Camera + Manual Focus Lens + High power Lighting)	Narrow view	Color	16.7 ms	FZ-SQ010F
	Standard view	Color		FZ-SQ050F
	Wide View (long-distance)	Color		FZ-SQ100F
	Wide View (short-distance)	Color		FZ-SQ100N

* When connected using two camera cables.

Camera Accessories

Item	Descriptions		Model
—	External Lighting		FLV Series *
—			FL Series *
	Lighting Controller (Required to control external lighting from a Controller)	For FLV-Series	Camera Mount Lighting Controller (One channel)
			Camera Mount Lighting Controller (Four channels)
			Analog Lighting Controller
		For FL-Series	Camera Mount Lighting Controller
	For Intelligent Compact Camera		Mounting Bracket
			Mounting Brackets
			Polarizing Filter Attachment
—	Mounting Bracket for FZ-S□		FZ-S-XLC
—	Mounting Bracket for FZ-S□2M		FZ-S2M-XLC
—	Mounting Bracket for FZ-S5M□2		FZ-S5M-XLC
—	Mounting Bracket for FZ-SH□		FZ-SH-XLC
—	Mounting Bracket for FH-S□12		FH-SM12-XLC

* Refer to the Vision Accessory Catalog (Cat. No. Q198) for details.





Cables

Item	Descriptions	Model
	Camera Cable Cable length: 2 m, 5 m, or 10 m *2	FZ-VS
	Bend resistant Camera Cable Cable length: 2 m, 5 m, or 10 m *2	FZ-VSB
	Right-angle Camera Cable *1 Cable length: 2 m, 5 m, or 10 m *2	FZ-VSL
	Long-distance Camera Cable Cable length: 15 m *2	FZ-VS2
	Long-distance Right-angle Camera Cable Cable length: 15 m *2	FZ-VSL2
	Cable Extension Unit Up to two Extension Units and three Cables can be connected. (Maximum cable length: 45 m *2)	FZ-VSJ
	Monitor Cable Cable length: 2 m or 5 m (When you connect a LCD Monitor FZ-M08 to FH sensor controller, please use it in combination with a DVI-I -RGB Conversion Connector FH-VMRGB.)	FZ-VM
	DVI-I -RGB Conversion Connector For FH Sensor Controllers only	FH-VMRGB
	Parallel I/O Cable Cable length: 2 m or 5 m, For FZ Sensor Controllers only	FZ-VP
	Parallel I/O Cable for Connector-terminal Conversion Unit Cable length: 2 m or 5 m, For FZ Sensor Controllers only Connector-Terminal Block Conversion Units can be connected (Terminal Blocks Recommended Products: OMRON XW2R-J50G-T, XW2R-E50G-T, XW2R-P50G-T)	FZ-VPX

*1 This Cable has an L-shaped connector on the Camera end.

*2 The maximum cable length depends on the Camera being connected, and the model and length of the Cable being used. For further information, please refer to the "Cameras / Cables" table.





When a high-speed CMOS camera FH-S□02/-S□04/-S□12 is used in the high speed mode of transmission speed, two camera cables are required.

Item	Descriptions	Model
	Parallel I/O Cable *3 Cable length: 2 m or 5 m, For FH Sensor Controllers only	XW2Z-S013-□ *4
	Parallel I/O Cable for Connector-terminal Conversion Unit *3 Cable length: 0.5 m, 1 m, 1.5 m, 2 m, 3 m, 5 m, For FH Sensor Controllers only Connector-Terminal Block Conversion Units can be connected (Terminal Blocks Recommended Products: OMRON XW2R-□34G-T)	XW2Z-□□□EE *5
	Connector-Terminal Block Conversion Units, General-purpose devices	XW2R-□34G-T *6
	Encoder Cable for line-driver Cable length: 1.5 m, For FH Sensor Controllers only	FH-VR

- *3 2 Cables are required for all I/O signals.
- *4 Insert the cables length into □ in the model number as follows. 2 m = 2, 5 m = 5
- *5 Insert the cables length into □□□ in the model number as follows. 0.5 m = 050, 1 m = 100, 1.5 m = 150, 2 m = 200, 3 m = 300, 5 m = 500
- *6 Insert the wiring method into □ in the model number as follows. Phillips screw = J, Slotted screw (rise up) = E, Push-in spring = P
Refer to the XW2R Series catalog (Cat. No. G077) for details.

Recommended EtherCAT and EtherNet/IP Communications Cables









Use Straight STP (shielded twisted-pair) cable of category 5 or higher with double shielding (braiding and aluminum foil tape) for EtherCAT.
Use Straight or cross STP (shielded twisted-pair) cable of category 5 or higher for EtherNet/IP.

Item	Descriptions			Model
	For EtherCAT *1	Standard type Cable with Connectors on Both Ends (RJ45/RJ45) Wire Gauge and Number of Pairs: AWG27, 4-pair Cable, Cable Sheath material: LSZH *2, Cable color: Blue, Yellow, or Green, Cables length: 0.2m, 0.3m, 0.5m, 1m, 1.5m, 2m, 3m, 5m, 7.5m, 10m, 15m, 20m		XS6W-6LSZH8SS□CM-Y *3
		Rugged type Cable with Connectors on Both Ends (RJ45/RJ45) Wire Gauge and Number of Pairs: AWG22, 2-pair Cable Cables length: 0.3m, 0.5m, 1m, 2m, 3m, 5m, 10m, 15m		XS5W-T421-□MD-K *3
		Rugged type Cable with Connectors on Both Ends (M12/RJ45) Wire Gauge and Number of Pairs: AWG22, 2-pair Cable Cables length: 0.3m, 0.5m, 1m, 2m, 3m, 5m, 10m, 15m		XS5W-T421-□MC-K *3
		Rugged type Cable with Connectors on Both Ends (M12 L/RJ45) Wire Gauge and Number of Pairs: AWG22, 2-pair Cable Cables length: 0.3m, 0.5m, 1m, 2m, 3m, 5m, 10m, 15m		XS5W-T422-□MC-K *3
--	For EtherCAT *1 and EtherNet/IP	Wire Gauge and Number of Pairs: AWG24, 4-pair Cable	Cables	Hitachi Cable, Ltd. NETSTAR-C5E SAB 0.5 × 4P *4
--			Cables	Kuramo Electric Co. KETH-SB *4
--			Cables	SWCC Showa Cable Systems Co. FAE-5004 *4
--		RJ45 Connectors	Panduit Corporation MPS588-C *4	
--		Wire Gauge and Number of Pairs: AWG22, 2-pair Cable	Cables	Kuramo Electric Co. KETH-PSB-OMR *5
--			Cables	Nihon Electric Wire&Cable Co.,Ltd. PNET/B *5
		RJ45 Assembly Connector	OMRON XS6G-T421-1 *5	
--	For EtherNet/IP	Wire Gauge and Number of Pairs: 0.5 mm, 4-pair Cable	Cables	Fujikura Ltd. F-LINK-E 0.5mm × 4P *6
--			RJ45 Connectors	Panduit Corporation MPS588 *6

Note: Please be careful while cable processing, for EtherCAT, connectors on both ends should be shield connected and for EtherNet/IP, connectors on only one end should be shield connected.

- *1 The FH series supports the EtherCAT communication. It cannot be used in FZ series.
- *2 The lineup features Low Smoke Zero Halogen cables for in-cabinet use and PUR cables for out-of-cabinet use.
- *3 For details, refer to Cat.No.G019.
- *4 We recommend you to use above cable for EtherCAT and EtherNet/IP, and RJ45 Connector together.
- *5 We recommend you to use above cable for EtherCAT and EtherNet/IP, and RJ45 Assembly Connector together.
- *6 We recommend you to use above cable For EtherNet/IP and RJ45 Connectors together.

Accessories

Item	Descriptions			Model	
	LCD Monitor For Box-type Controllers			FZ-M08	
	USB Memory	2 GB		FZ-MEM2G	
		8 GB		FZ-MEM8G	
	SD Card For FH Sensor Controllers only	2 GB		HMC-SD291	
		4 GB		HMC-SD491	
	VESA Attachment For installing the LCD integrated-type controller			FZ-VESA	
	Desktop Controller Stand For installing the LCD integrated-type controller			FZ-DS	
	Display/USB Switcher			FZ-DU	
--	Mouse Recommended Products Driverless wired mouse (A mouse that requires the mouse driver to be installed is not supported.)			—	
	EtherCAT junction slaves For FH Sensor Controllers only	3 port	Power supply voltage: 20.4 to 28.8 VDC (24 VDC -15 to 20%)	Current consumption: 0.08 A	GX-JC03
		6 port		Current consumption: 0.17 A	GX-JC06
	Industrial Switching Hubs for EtherNet/IP and Ethernet	3 port	Failure detection: None	Current consumption: 0.08 A	W4S1-03B
		5 port	Failure detection: None	Current consumption: 0.12 A	W4S1-05B
		5 port	Failure detection: Supported		W4S1-05C

Automation Software Sysmac Studio

Please purchase a DVD and licenses the first time you purchase the Sysmac Studio. DVDs and licenses are available individually. The license does not include the DVD.

Product	Specifications	Number of Model Standards licenses		Media	Model
Sysmac Studio Standard Edition Ver.1.□□	The Sysmac Studio provides an integrated development environment to set up, program, debug, and maintain NJ-series Controllers and other Machine Automation Controllers, as well as EtherCAT slaves. Sysmac Studio runs on the following OS. Windows XP (Service Pack 3 or higher, 32-bit version) / Vista (32-bit version) / 7 (32-bit/64-bit version) / 8 (32-bit/64-bit version)	-- (Media only)		DVD *1	SYSMAC-SE200D
		1 license		—	SYSMAC-SE201L
		3 license		—	SYSMAC-SE203L
		10 license		—	SYSMAC-SE210L
		30 license		—	SYSMAC-SE230L
		50 license		—	SYSMAC-SE250L
Sysmac Studio Vision Edition Ver.1.□□ *2	Sysmac Studio Vision Edition is a limited license that provides selected functions required for FH-series/ FQ-M-series Vision Sensor settings.	1 license		—	SYSMAC-VE001L

Note: 1. Site licenses are available for users who will run Sysmac Studio on multiple computers. Ask your OMRON sales representative for details.
2. Sysmac Studio version 1.07 or higher supports the FH Series. Sysmac Studio does not support the FZ5 Series.

*1 The same media is used for both the Standard Edition and the Vision Edition.

*2 With the Vision Edition, you can use only the setup functions for FH-series/FQ-M-series Vision Sensors.









Development Environment

Please purchase a CD-ROM and licenses the first time you purchase the Application Producer. CD-ROMs and licenses are available individually. The license does not include the CD-ROM.

Product	Specifications	Number of Model Standards licenses		Media	Model
Application Producer	Software components that provide a development environment to further customize the standard controller features of the FH Series. System requirements: • CPU: Intel Pentium Processor (SSE2 or higher) • OS: Windows 7 (32-bit/64-bit version) / 8 (32-bit/64-bit version) • .NET Framework: .NET Framework 3.5 or higher • Memory: At least 2 GB RAM Available disk space: At least 2 GB • Browser: Microsoft® Internet Explorer 6.0 or later • Display: XGA (1024 × 768), True Color (32-bit) or higher • Optical drive: CD/DVD drive The following software is required to customize the software: Microsoft® Visual Studio® 2010 Professional or Microsoft® Visual Studio® 2008 Professional or Microsoft® Visual Studio® 2012 Professional	-- (Media only)		CD-ROM	FH-AP1
		1 license		—	FH-AP1L

Lenses







C-mount Lens for 1/3-inch image sensor (Recommend: FZ-S□/FZ-SH□/FH-S□)

Model	3Z4S-LE SV-0614V	3Z4S-LE SV-0813V	3Z4S-LE SV-1214V	3Z4S-LE SV-1614V	3Z4S-LE SV-2514V	3Z4S-LE SV-3518V	3Z4S-LE SV-5018V	3Z4S-LE SV-7527V	3Z4S-LE SV-10035V
Appearance/Dimensions (mm)									
Focal length	6 mm	8 mm	12 mm	16 mm	25 mm	35 mm	50 mm	75 mm	100 mm
Brightness	F1.4	F1.3	F1.4	F1.4	F1.4	F1.8	F1.8	F2.7	F3.5
Filter size	M27.0 P0.5	M25.5 P0.5	M27.0 P0.5	M27.0 P0.5	M27.0 P0.5	M27.0 P0.5	M30.5 P0.5	M30.5 P0.5	M30.5 P0.5
Maximum sensor size	1/3 inch	1/3 inch	1/3 inch	1/3 inch	1/3 inch	1/3 inch	1/3 inch	1/3 inch	1/3 inch
Mount	C mount								







C-mount Lens for 2/3-inch image sensor (Recommend: FZ-S□2M/FZ-S□5M2) (3Z4S-LE SV-7525H and 3Z4S-LE SV-10028H can also be used for FH-S□02 and FH-S□04)

Model	3Z4S-LE SV-0614H	3Z4S-LE SV-0814H	3Z4S-LE SV-1214H	3Z4S-LE SV-1614H	3Z4S-LE SV-2514H	3Z4S-LE SV-3514H	3Z4S-LE SV-5014H	3Z4S-LE SV-7525H	3Z4S-LE SV-10028H
Appearance/Dimensions (mm)									
Focal length	6 mm	8 mm	12 mm	16 mm	25 mm	35 mm	50 mm	75 mm	100 mm
Brightness	F1.4	F1.4	F1.4	F1.4	F1.4	F1.4	F1.4	F2.5	F2.8
Filter size	M40.5 P0.5	M35.5 P0.5	M27.0 P0.5	M27.0 P0.5	M27.0 P0.5	M35.5 P0.5	M40.5 P0.5	M34.0 P0.5	M37.5 P0.5
Maximum sensor size	2/3 inch	2/3 inch	2/3 inch	2/3 inch	2/3 inch	2/3 inch	2/3 inch	1 inch	1 inch
Mount	C mount								

C-mount Lens for 1-inch image sensor (Recommend: FH-S□02/FH-S□04) (3Z4S-LE SV-7525H with focal length of 75 mm and 3Z4S-LE SV-10028H with focal length of 100 mm are also available.)

Model	3Z4S-LE VS-0618H1	3Z4S-LE VS-0814H1	3Z4S-LE VS-1214H1	3Z4S-LE VS-1614H1	3Z4S-LE VS-2514H1	3Z4S-LE VS-3514H1	3Z4S-LE VS-5018H1
Appearance/Dimensions (mm)							
Focal length	6 mm	8 mm	12 mm	16 mm	25 mm	35 mm	50 mm
Brightness	F1.8	F1.4	F1.4	F1.4	F1.4	F1.4	F1.8
Filter size	Can not be used a filter	M55.0 P0.75	M35.5 P0.5	M30.5 P0.5	M30.5 P0.5	M30.5 P0.5	M40.5 P0.5
Maximum sensor size	1 inch	1 inch	1 inch	1 inch	1 inch	1 inch	1 inch
Mount	C mount						

M42-mount Lens for large image sensor (Recommend: FH-S□12)

Model	3Z4S-LE VS-L1828/M42-10	3Z4S-LE VS-L2526/M42-10	3Z4S-LE VS-L3528/M42-10	3Z4S-LE VS-L5028/M42-10	3Z4S-LE VS-L8540/M42-10	3Z4S-LE VS-L10028/M42-10
Appearance/Dimensions (mm)						
Focal length	18 mm	25 mm	35 mm	50 mm	85 mm	100 mm
Brightness	F2.8	F2.6	F2.8	F2.8	F4.0	F2.8
Filter size	M55.0 P0.75	M55.0 P0.75	M62.0 P0.75	M62.0 P0.75	M52.0 P0.75	M52.0 P0.75
Maximum sensor size	1.8 inch					
Mount	M42 mount					



Lenses for small camera



Model	FZ-LES3	FZ-LES6	FZ-LES16	FZ-LES30
Appearance/Dimensions (mm)				
Focal length	3 mm	6 mm	16 mm	30 mm
Brightness	F2.0	F2.0	F3.4	F3.4



FH-Series

Vibrations and Shocks Resistant C-mount Lens for 2/3-inch image sensor (Recommend: FZ-S□/FZ-S□M/FZ-S□M2/FZ-SH□/FH-S□)

(Vibrations and Shocks Resistant Lenses for 1-inch image sensors and for large image sensors are also available. Ask your OMRON representative for details.)

Model	3Z4S-LE VS-MC15-□□□□□ *1									3Z4S-LE VS-MC20-□□□□□ *1								
Appearance/ Dimensions (mm)																		
Focal length	15 mm									20 mm								
Filter size	M27.0 P0.5									M27.0 P0.5								
Optical magnification	0.03 ×			0.2 ×			0.3 ×			0.04 ×			0.25 ×			0.4 ×		
Iris Range *2	Maximum aperture	F5.6	F8	Maximum aperture	F5.6	F8	Maximum aperture	F5.6	F8	Maximum aperture	F5.6	F8	Maximum aperture	F5.6	F8	Maximum aperture	F5.6	F8
Depth of field (mm) *3	183.1	512.7	732.4	4.8	13.4	19.2	2.3	6.5	9.2	110.8	291.2	416.0	3.4	9.0	12.8	1.5	3.9	5.6
Maximum sensor size	2/3 inch																	
Mount	C Mount																	

Model	3Z4S-LE VS-MC25N-□□□□□ *1									3Z4S-LE VS-MC30-□□□□□ *1								
Appearance/ Dimensions (mm)																		
Focal length	25 mm									30 mm								
Filter size	M27.0 P0.5									M27.0 P0.5								
Optical magnification	0.05 ×			0.25 ×			0.5 ×			0.06 ×			0.15 ×			0.45 ×		
Iris Range *2	Maximum aperture	F5.6	F8	Maximum aperture	F5.6	F8	Maximum aperture	F5.6	F8	Maximum aperture	F5.6	F8	Maximum aperture	F5.6	F8	Maximum aperture	F5.6	F8
Depth of field (mm) *3	67.2	188.2	268.8	3.2	9.0	12.8	1.0	2.7	3.8	47.1	131.9	188.4	8.2	22.9	32.7	1.1	3.2	4.6
Maximum sensor size	2/3 inch																	
Mount	C Mount																	

Model	3Z4S-LE VS-MC35-□□□□□ *1									3Z4S-LE VS-MC50-□□□□□ *1								
Appearance/ Dimensions (mm)																		
Focal length	35 mm									50 mm								
Filter size	M27.0 P0.5									M27.0 P0.5								
Optical magnification	0.26 ×			0.3 ×			0.65 ×			0.08 ×			0.2 ×			0.48 ×		
Iris Range *2	Maximum aperture	F5.6	F8	Maximum aperture	F5.6	F8	Maximum aperture	F5.6	F8	Maximum aperture	F5.6	F8	Maximum aperture	F5.6	F8	Maximum aperture	F5.6	F8
Depth of field (mm) *3	2.8	8.4	11.9	2.2	6.5	9.2	0.6	1.7	2.5	33.8	75.6	108.0	6.0	13.4	19.2	1.3	2.9	4.1
Maximum sensor size	2/3 inch																	
Mount	C Mount																	

Model	3Z4S-LE VS-MC75-□□□□□ *1								
Appearance/ Dimensions (mm)									
Focal length	75 mm								
Filter size	M27.0 P0.5								
Optical magnification	0.14 ×			0.2 ×			0.62 ×		
Iris Range *2	Maximum aperture	F5.6	F8	Maximum aperture	F5.6	F8	Maximum aperture	F5.6	F8
Depth of field (mm) *3	17.7	26.1	37.2	9.1	13.4	19.2	1.3	1.9	2.7
Maximum sensor size	2/3 inch								
Mount	C Mount								

*1 Insert the iris range into □□□□□ in the model number as follows.

F=Maximum aperture: blank
F=5.6: FN056
F=8: FN080

*2 F-number can be selected from maximum aperture, 5.6, and 8.0.

*3 When circle of least confusion is 40 μm.

Extension Tubes

Lenses	For M42 mount Lenses *	For C mount Lenses *	For Small Digital CCD Cameras
Model	3Z4S-LE VS-EXR/M42	3Z4S-LE SV-EXR	FZ-LESR
Contents	Set of 5 tubes (20 mm, 10 mm, 8 mm, 2 mm, and 1 mm) Maximum outer diameter: 47.5 mm dia.	Set of 7 tubes (40 mm, 20 mm, 10 mm, 5 mm, 2.0 mm, 1.0 mm, and 0.5 mm) Maximum outer diameter: 30 mm dia.	Set of 3 tubes (15 mm, 10 mm, 5 mm) Maximum outer diameter: 12 mm dia.

* Do not use the 0.5-mm, 1.0-mm, and 2.0-mm Extension Tubes attached to each other. Since these Extension Tubes are placed over the threaded section of the Lens or other Extension Tube, the connection may loosen when more than one 0.5-mm, 1.0-mm or 2.0-mm Extension Tube are used together. Reinforcement is required to protect against vibration when Extension Tubes exceeding 30 mm are used. When using the Extension Tube, check it on the actual device before using it.

Ratings and Specifications (Sensor Controllers)

FH Sensor Controllers

Type		High-speed Controllers (4 core)			Standard Controllers (2 core)					
Model	NPN		FH-3050	FH-3050-10	FH-3050-20	FH-1050	FH-1050-10	FH-1050-20		
	PNP									
Main functions	Controller type		Box-type controllers							
	No. of Cameras		2	4	8	2	4	8		
	Connected Camera		Can be connected to all cameras. (FZ-S series/FH-S series)			Can be connected to all cameras. (FZ-S series/FH-S series) (Can be connected to up to four 12 million-pixel cameras or up to eight cameras other than 12 million-pixel cameras.)	Can be connected to all cameras. (FZ-S series/FH-S series)		Can be connected to all cameras. (FZ-S series/FH-S series) (Can be connected to up to four 12 million-pixel cameras or up to eight cameras other than 12 million-pixel cameras.)	
	Processing resolution (FZ-S)	When connected to an intelligent compact camera		752 (H) × 480 (V)						
		When connected to a 300,000-pixel camera		640 (H) × 480 (V)						
		When connected to a 2 million-pixel camera		1600 (H) × 1200 (V)						
	Processing resolution (FH-S)	When connected to a 5 million-pixel camera		2448 (H) × 2044 (V)						
		When connected to a 300,000-pixel camera		640 (H) × 480 (V)						
		When connected to a 2 million-pixel camera		2040 (H) × 1088 (V)						
	When connected to a 4 million-pixel camera		2040 (H) × 2048 (V)							
	When connected to a 12 million-pixel camera		4084 (H) × 3072 (V)							
	No. of scenes		128							
	Number of logged images *1	When connected to an intelligent compact camera		Connected to 1 camera(Color): 232, Connected to 2 camera(Color): 116 Connected to 3 camera(Color): 77, Connected to 4 camera(Color): 58 Connected to 5 camera(Color): 46, Connected to 6 camera(Color): 38 Connected to 7 camera(Color): 33, Connected to 8 camera(Color): 29						
		When connected to a 300,000-pixel camera (FZ-S/FH-S)		Connected to 1 camera(Color): 270, Connected to 1 camera(Monochrome): 272 Connected to 2 camera(Color): 135, Connected to 2 camera(Monochrome): 136 Connected to 3 camera(Color/Monochrome): 90 Connected to 4 camera(Color): 67, Connected to 4 camera(Monochrome): 68 Connected to 5 camera(Color/Monochrome): 54 Connected to 6 camera(Color/Monochrome): 45 Connected to 7 camera(Color/Monochrome): 38 Connected to 8 camera(Color): 33, Connected to 8 camera(Monochrome): 34						
		When connected to a 2 million-pixel camera (FH-S)		Connected to 1 camera(Color/Monochrome): 37, Connected to 2 camera(Color/Monochrome): 18 Connected to 3 camera(Color/Monochrome): 12, Connected to 4 camera(Color/Monochrome): 9 Connected to 5 camera(Color/Monochrome): 7, Connected to 6 camera(Color/Monochrome): 6 Connected to 7 camera(Color/Monochrome): 5, Connected to 8 camera(Color/Monochrome): 4						
When connected to a 2 million-pixel camera (FZ-S)		Connected to 1 camera(Color/Monochrome): 43, Connected to 2 camera(Color/Monochrome): 21 Connected to 3 camera(Color/Monochrome): 14, Connected to 4 camera(Color/Monochrome): 10 Connected to 5 camera(Color/Monochrome): 8, Connected to 6 camera(Color/Monochrome): 7 Connected to 7 camera(Color/Monochrome): 6, Connected to 8 camera(Color/Monochrome): 5								
When connected to a 4 million-pixel camera (FH-S)		Connected to 1 camera(Color/Monochrome): 20, Connected to 2 camera(Color/Monochrome): 10 Connected to 3 camera(Color/Monochrome): 6, Connected to 4 camera(Color/Monochrome): 5 Connected to 5 camera(Color/Monochrome): 4, Connected to 6 camera(Color/Monochrome): 3 Connected to 7 camera(Color/Monochrome): 2, Connected to 8 camera(Color/Monochrome): 2								
When connected to a 5 million-pixel camera (FZ-S)		Connected to 1 camera(Color/Monochrome): 16, Connected to 2 camera(Color/Monochrome): 8 Connected to 3 camera(Color/Monochrome): 5, Connected to 4 camera(Color/Monochrome): 4 Connected to 5 camera(Color/Monochrome): 3, Connected to 6 camera(Color/Monochrome): 2 Connected to 7 camera(Color/Monochrome): 2, Connected to 8 camera(Color/Monochrome): 2								
When connected to a 12 million-pixel camera (FH-S)		Connected to 1 camera(Color/Monochrome): 6, Connected to 2 camera(Color/Monochrome): 3 Connected to 3 camera(Color/Monochrome): 2, Connected to 4 camera(Color/Monochrome): 2								
Operation		Mouse or similar device								
Settings		Create series of processing steps by editing the flowchart (Help messages provided).								
External interface	Serial communications		RS-232C: 1 CH							
	EtherNet communications		No-protocol (TCP/UDP) 1000BASE-T							
			1 port	2 port	2 port	1 port	2port	2port		
	EtherNet/IP communications		Ethernet port baud rate: 1 Gbps (1000 BASE-T)							
	EtherCAT communications		EtherCAT protocol (100BASE-TX)							
	Parallel I/O		(In the 2-line random trigger mode) 17 inputs (STEP0/ENCTRIG_Z0, STEP1/ENCTRIG_Z1, ENCTRIG_A0 to 1, ENCTRIG_B0 to 1, DSA0 to 1, DI0 to 7, DL_LINE0) 37 outputs (RUN0 to 1, READY0 to 1, BUSY0 to 1, OR0 to 1, ERROR0 to 1, GATE0 to 1, STGOUT0/SHTOUT0, STGOUT1/SHTOUT1, STGOUT2 to 7, DO0 to 15, ACK) (In the 5-line to 8-line random trigger mode) 19 inputs, STEP0 to 7, DL_LINE0 to 2, DI0 to 7) 34 outputs (READY0 to 7, BUSY0 to 7, OR0 to 7, ACK, ERROR, STGOUT/SHTOUT0 to 7)							
	Encoder interface		RS422-A line driver level. Phase A/B: single-phase 4MHz (multiplying phase difference of 1MHz by 4 times), Phase Z: 1MHz							
	Monitor interface		DVI-I output IF × 1ch							
	USB interface		4 channels (supports USB 1.1 and 2.0)							
	SD card interface		SDHC card of Class4 or higher rating is recommended.							
Ratings	Power supply voltage		20.4 to 26.4 VDC							
	Current consumption (at 24.0 VDC) *2	When connected to an intelligent compact camera	Connected to 2 cameras	5.0 A max.	5.4 A max.	6.4 A max.	4.7 A max.	5.0 A max.	5.9 A max.	
			Connected to 4 cameras	—	7.0 A max.	8.1 A max.	—	6.5 A max.	7.5 A max.	
		When connected to a 300,000-pixel camera, 2 million-pixel camera, 4 million-pixel camera, 5 million-pixel camera or 12 million-pixel camera	Connected to 8 cameras	—	—	11.5 A max.	—	—	—	10.9 A max.
			Connected to 2 cameras	4.1 A max.	4.2 A max.	5.2 A max.	3.6 A max.	3.7 A max.	4.5 A max.	
Connected to 4 cameras	—	4.8 A max.	5.6 A max.	—	4.3 A max.	5.0 A max.				
Connected to 8 cameras	—	—	6.8 A max.	—	—	6.2 A max.				
Insulation resistance		Between DC power supply and controller FG: 20 MΩ or higher (rated voltage 250 V)								
Operation Environment	Noise Immunity	Fast transient burst	DC Power Supply		Direct infusion: 2 KV Pulse rising: 5 ns Pulse width: 50 ns Burst continuation time: 15 ms/0.75 ms Period: 300 ms Application time: 1 min Cramp: 1 KV Pulse rising: 5 ns Pulse width: 50 ns Burst continuation time: 15 ms/0.75 ms Period: 300 ms Application time: 1 min					
			I/O line							
	Ambient temperature range		Operating: 0 to 50 °C Storage: -20 to 65 °C (with no icing or condensation)							
	Ambient humidity range		Operating and storage: 35% to 85% (with no condensation)							
	Ambient atmosphere		No corrosive gases							
Grounding		Type D grounding (100Ω or less grounding resistance) Conventional type 3 grounding								
Degree of protection		IEC60529 IP20								
Dimensions	Dimensions		190 × 115 × 182.5 mm							
	Weight		Approx. 3.2 kg	Approx. 3.4 kg	Approx. 3.4 kg	Approx. 3.2 kg	Approx. 3.4 kg	Approx. 3.4 kg		
	Case materials		Cover: zinc-plated steel plate, side plate: aluminum (A6063)							
Accessories		Controller (1) / user manual (one Japanese and one English versions) / Instruction Installation Manual (1) / Power supply terminal block connector (1) / Ferrite core (2, FH-3050 and FH-1050), 4 (FH-3050-10 and FH-1050-10), and 8 (FH-3050-20 and FH-1050-20)								

*1 The image logging capacity changes when multiple cameras of different types are connected at the same time.

*2 The current consumption when the maximum number of cameras supported by each controller are connected.

If a lighting controller model is connected to a lamp, the current consumption is as high as when an intelligent compact camera is connected.

FZ5 Sensor Controllers

Type		High-speed Controllers		Standard Controllers		Lite Controllers	
Model	NPN	FZ5-1100	FZ5-1100-10	FZ5-600	FZ5-600-10	FZ5-L350	FZ5-L350-10
Controller type	PNP	FZ5-1105	FZ5-1105-10	FZ5-605	FZ5-605-10	FZ5-L355	FZ5-L355-10
No. of Cameras		Controllers integrated with LCD				Box-type controllers	
Connected Camera		Can be connected to FZ-S series. (Can not be connected to FH-S series.)		Can be connected to FZ-S series. (Can not be connected to FH-S series. When connecting 5 million-pixel cameras, up to two cameras can be connected.)			
Processing resolution	When connected to an intelligent compact camera	752 (H) × 480 (V)					
	When connected to a 300,000-pixel camera	640 (H) × 480 (V)					
	When connected to a 2 million-pixel camera	1600 (H) × 1200 (V)					
	When connected to a 5 million-pixel camera	2448 (H) × 2044 (V)					
No. of scenes		128					
Number of logged images *1	When connected to an intelligent compact camera	Connected to 1 camera	232	214			
		Connected to 2 cameras	116	107			
		Connected to 3 cameras	77	71			
		Connected to 4 cameras	58	53			
	When connected to a 300,000-pixel camera	Connected to 1 camera	Color camera: 270, Monochrome Camera: 272		Color camera: 250, Monochrome Camera: 252		
		Connected to 2 cameras	Color camera: 135, Monochrome Camera: 136		Color camera: 125, Monochrome Camera: 126		
		Connected to 3 cameras	Color camera: 90, Monochrome Camera: 90		Color camera: 83, Monochrome Camera: 84		
		Connected to 4 cameras	Color camera: 67, Monochrome Camera: 68		Color camera: 62, Monochrome Camera: 63		
	When connected to a 2 million-pixel camera	Connected to 1 camera	Color camera: 43, Monochrome Camera: 43		Color camera: 40, Monochrome Camera: 40		
		Connected to 2 cameras	Color camera: 21, Monochrome Camera: 21		Color camera: 20, Monochrome Camera: 20		
		Connected to 3 cameras	Color camera: 14, Monochrome Camera: 14		Color camera: 13, Monochrome Camera: 13		
		Connected to 4 cameras	Color camera: 10, Monochrome Camera: 10		Color camera: 10, Monochrome Camera: 10		
	When connected to a 5 million-pixel camera	Connected to 1 camera	Color camera: 16, Monochrome Camera: 16		Color camera: 11, Monochrome Camera: 11		
		Connected to 2 cameras	Color camera: 8, Monochrome Camera: 8		Color camera: 5, Monochrome Camera: 5		
		Connected to 3 cameras	Color camera: 5, Monochrome Camera: 5		-		
		Connected to 4 cameras	Color camera: 4, Monochrome Camera: 4		-		
Operation		Touch pen, mouse, etc.				Mouse or similar device	
Settings		Create series of processing steps by editing the flowchart (Help messages provided).					
Serial communications		RS-232C/422A : 1 CH				RS-232: 1CH	
EtherNet communications		Ethernet 100BASE-TX/10BASE-T				Ethernet 1000BASE-T/100BASE-TX/10BASE-T	
EtherNet/IP communications		Ethernet port baud rate: 100 Mbps (100Base-TX)					
Parallel I/O		(When used in Multi-line random-trigger mode) 17 inputs (RESET, STEP0/ENCTRIG_Z0, STEP1/ENCTRIG_Z1, DSA0 to 1, ENCTRIG_A0 to 1, ENCTRIG_B0 to 1, DI0 to 7), 29 outputs (RUN/BUSY1, BUSY0, GATE0 to 1, OR0 to 1, READY0 to 1, ERROR, STGOUT0 to 3, DO0 to 15) (When used in other mode) 13 inputs (RESET, STEP0/ENCTRIG_Z0, DSA0, ENCTRIG_A0, ENCTRIG_B0, DI0 to 7), 26 outputs (RUN, BUSY0, GATE0, OR0, READY0, ERROR, STGOUT0 to 3, DO0 to 15) * STGOUT 2 to 3 only for camera 4 ch type		13 inputs (RESET, STEP0/ENCTRIG_Z0, DSA0, ENCTRIG_A0, ENCTRIG_B0, DI0 to 7), 26 outputs (RUN, BUSY0, GATE0, OR0, READY0, ERROR, STGOUT0 to 3, DO0 to 15) * STGOUT 2 to 3 only for camera 4 ch type		11 inputs (RESET, STEP, DSA, and DI 0 to 7), 26 outputs (RUN, BUSY, GATE, OR, READY, ERROR, STGOUT 0 to 3, and DO 0 to 15) * STGOUT 2 to 3 only for camera 4 ch type	
Monitor interface		Integrated Controller and LCD 12.1 inch TFT color LCD (Resolution: XGA 1,024 × 768 dots)				Analog RGB video output, 1 channel (Resolution: XGA 1,024 × 768 dots)	
USB interface		4 channels (supports USB 1.1 and 2.0)				2CH (supports USB1.1/2.0)	
Power supply voltage *2		20.4 to 26.4 VDC					
Current consumption (at 24.0 VDC) *3	When connected to an intelligent compact camera	5.0 A max.	7.5 A max.	5.0 A max.	7.5 A max.	4.0 A max.	5.5 A max.
	When connected to a 300,000-pixel camera						
	When connected to a 2 million-pixel camera	3.7 A max.	4.9 A max.	3.7 A max.	4.9 A max.	2.6 A max.	2.9 A max.
	When connected to a 5 million-pixel camera						
Ambient temperature range		Operating: 0 to 45 °C for low cooling fan speeds, 0 to 50 °C for high cooling fan speeds Storage: -20 to 65 °C (with no icing or condensation)				Operating: 0 to 45 °C, 0 to 50 °C Storage: -20 to 65 °C (with no icing or condensation)	
Ambient humidity range		Operating and storage: 35% to 85% (with no condensation)					
Weight		Approx. 3.2 kg	Approx. 3.4 kg	Approx. 3.2 kg	Approx. 3.4 kg	Approx. 1.8 kg	
Accessories		Touch pen (one, inside the front panel), Instruction Manual, 6 mounting brackets					

*1 The image logging capacity changes when multiple cameras of different types are connected at the same time.

*2 Do not ground the positive terminal of the 24-VDC power supply to a Lite Controller.

If the positive terminal is grounded, electrical shock may occur when an SG (0-V) part, such as the case of the Controller or Camera, is touched.

*3 The current consumption when the maximum number of cameras supported by each controller are connected.

If a lighting controller model is connected to a lamp, the current consumption is as high as when an intelligent compact camera is connected.

Ratings and Specifications (Cameras)

High-speed CMOS cameras

Model	FH-SM	FH-SC	FH-SM02	FH-SC02	FH-SM04	FH-SC04	FH-SM12	FH-SC12
Image elements	CMOS image elements (1/3-inch equivalent)		CMOS image elements (2/3-inch equivalent)		CMOS image elements (1-inch equivalent)		CMOS image elements (1.76-inch equivalent)	
Color/Monochrome	Monochrome	Color	Monochrome	Color	Monochrome	Color	Monochrome	Color
Effective pixels	640 (H) × 480 (V)		2040 (H) × 1088 (V)		2040 (H) × 2048 (V)		4084 (H) × 3072 (V)	
Imaging area H × V (opposing corner)	4.8 × 3.6 (6.0 mm)		11.26 × 5.98 (12.76 mm)		11.26 × 11.26 (15.93 mm)		22.5 × 16.9 (28.14 mm)	
Pixel size	7.4 (μm) × 7.4 (μm)		5.5 (μm) × 5.5 (μm)		5.5 (μm) × 5.5 (μm)		5.5 (μm) × 5.5 (μm)	
Shutter function	Electronic shutter; Shutter speeds can be set from 20 μs to 100 ms.		Electronic shutter; Shutter speeds can be set from 25 μs to 100 ms.				Electronic shutter; Shutter speeds can be set from 60 μs to 100 ms.	
Partial function	1 to 480 lines	2 to 480 lines	1 to 1088 lines	2 to 1088 lines	1 to 2048 lines	2 to 2048 lines	4 to 3072 lines (4-line increments)	
Frame rate (image read time)	308 fps (3.3 ms)		219 fps (4.6 ms) *		118 fps (8.5 ms) *		38.9 fps (25.7 ms) *	
Lens mounting	C mount						M42 mount	
Field of vision, installation distance	Selecting a lens according to the field of vision and installation distance							
Ambient temperature range	Operating: 0 to 40 °C, Storage: -25 to 65 °C (with no icing or condensation)							
Ambient humidity range	Operating and storage: 35% to 85% (with no condensation)							
Weight	Approx. 105 g		Approx. 110 g				Approx. 320 g	
Accessories	Instruction manual							

* Frame rate in high speed mode when the camera is connected using two camera cables.

Digital CCD Cameras

Model	FZ-S	FZ-SC	FZ-S2M	FZ-SC2M	FZ-S5M2	FZ-SC5M2
Image elements	Interline transfer reading all pixels, CCD image elements (1/3-inch equivalent)		Interline transfer reading all pixels, CCD image elements (1/1.8-inch equivalent)		Interline transfer reading all pixels, CCD image elements (2/3-inch equivalent)	
Color/Monochrome	Monochrome	Color	Monochrome	Color	Monochrome	Color
Effective pixels	640 (H) × 480 (V)		1600 (H) × 1200 (V)		2448 (H) × 2044 (V)	
Imaging area H × V (opposing corner)	4.8 × 3.6 (6.0mm)		7.1 × 5.4 (8.9mm)		8.4 × 7.1 (11mm)	
Pixel size	7.4 (μm) × 7.4 (μm)		4.4 (μm) × 4.4 (μm)		3.45 (μm) × 3.45 (μm)	
Shutter function	Electronic shutter; select shutter speeds from 20 μs to 100 ms					
Partial function	12 to 480 lines		12 to 1200 lines		12 to 2044 lines	
Frame rate (image read time)	80 fps (12.5 ms)		30 fps (33.3 ms)		16 fps (62.5 ms)	
Lens mounting	C mount					
Field of vision, installation distance	Selecting a lens according to the field of vision and installation distance					
Ambient temperature range	Operating: 0 to 50 °C Storage: -25 to 65 °C (with no icing or condensation)		Operating: 0 to 40 °C Storage: -25 to 65 °C (with no icing or condensation)			
Ambient humidity range	Operating and storage: 35% to 85% (with no condensation)					
Weight	Approx. 55 g		Approx. 76 g		Approx. 140 g	
Accessories	Instruction manual					

Small CCD Digital Cameras

Model	FZ-SF	FZ-SFC	FZ-SP	FZ-SPC
Image elements	Interline transfer reading all pixels, CCD image elements (1/3-inch equivalent)			
Color/Monochrome	Monochrome	Color	Monochrome	Color
Effective pixels	640 (H) × 480 (V)			
Imaging area H × V (opposing corner)	4.8 × 3.6 (6.0mm)			
Pixel size	7.4 (μm) × 7.4 (μm)			
Shutter function	Electronic shutter; select shutter speeds from 20 μm to 100 ms			
Partial function	12 to 480 lines			
Frame rate (image read time)	80 fps (12.5ms)			
Lens mounting	Special mount (M10.5 P0.5)			
Field of vision, installation distance	Selecting a lens according to the field of vision and installation distance			
Ambient temperature range	Operating: 0 to 50 °C (camera amp) 0 to 45 °C (camera head) Storage: -25 to 65 °C (with no icing or condensation)			
Ambient humidity range	Operating and storage: 35% to 85% (with no condensation)			
Weight	Approx. 150 g			
Accessories	Instruction manual, installation bracket, Four mounting brackets (M2)		Instruction manual	

High-speed CCD Cameras

Model	FZ-SH	FZ-SHC
Image elements	Interline transfer reading all pixels, CCD image elements (1/3-inch equivalent)	
Color/Monochrome	Monochrome	Color
Effective pixels	640 (H) × 480 (V)	
Imaging area H x V (opposing corner)	4.8 × 3.6 (6.0mm)	
Pixel size	7.4 (μm) × 7.4 (μm)	
Shutter function	Electronic shutter; select shutter speeds from 1/10 to 1/50,000 s	
Partial function	12 to 480 lines	
Frame rate (image read time)	204 fps (4.9ms)	
Field of vision, installation distance	Selecting a lens according to the field of vision and installation distance	
Ambient temperature range	Operating: 0 to 40 °C Storage: -25 to 65 °C (with no icing or condensation)	
Ambient humidity range	Operating and storage: 35% to 85% (with no condensation)	
Weight	Approx. 105 g	
Accessories	Instruction manual	

Intelligent Compact CMOS Cameras

Model	FZ-SQ010F	FZ-SQ050F	FZ-SQ100F	FZ-SQ100N
Image elements	CMOS color image elements (1/3-inch equivalent)			
Color/Monochrome	Color			
Effective pixels	752 (H) × 480 (V)			
Imaging area H x V (opposing corner)	4.51 × 2.88 (5.35mm)			
Pixel size	6.0 (μm) × 6.0 (μm)			
Shutter function	1/250 to 1/32,258			
Partial function	8 to 480 lines			
Frame rate (image read time)	60 fps			
Field of vision	7.5 × 4.7 to 13 × 8.2 mm	13 × 8.2 to 53 × 33 mm	53 × 33 to 240 × 153 mm	29 × 18 to 300 × 191 mm
Installation distance	38 to 60 mm	56 to 215 mm	220 to 970 mm	32 to 380 mm
LED class *	Risk Group2			
Ambient temperature range	Operating: 0 to 50 °C Storage: -25 to 65 °C			
Ambient humidity range	Operating and storage: 35% to 85% (with no condensation)			
Weight	Approx. 150 g		Approx. 140 g	
Accessories	Mounting bracket (FQ-XL), polarizing filter attachment (FQ-XF1), instruction manual and warning label			

* Applicable standards: IEC62471-2

Ratings and Specifications (LCD Monitor, Cable)

LCD Monitor

Model	FZ-M08
Size	8.4 inches
Type	Liquid crystal color TFT
Resolution	1,024 × 768 dots
Input signal	Analog RGB video input, 1 channel
Power supply voltage	21.6 to 26.4 VDC
Current consumption	Approx. 0.7 A max.
Ambient temperature range	Operating: 0 to 50 °C; Storage: -25 to 65 °C (with no icing or condensation)
Ambient humidity range	Operating and storage: 35 to 85% (with no condensation)
Weight	Approx. 1.2 kg
Accessories	Instruction Sheet and 4 mounting brackets

Camera Cables

Model	FZ-VS (2 m)	FZ-VSB (2 m)	FZ-VSL (2 m)
Shock resistiveness (durability)	10 to 150 Hz single amplitude 0.15 mm 3 directions, 8 strokes, 4 times		
Ambient temperature range	Operation and storage: 0 to 65 °C (with no icing or condensation)		
Ambient humidity range	Operation and storage: 40 to 70%RH (with no condensation)		
Ambient atmosphere	No corrosive gases		
Material	Cable sheath, connector: PVC		
Minimum bending radius	69 mm	69 mm	69 mm
Weight	Approx. 170 g	Approx. 220 g	Approx. 170 g

Monitor Cable

Model	FZ-VM
Vibration resistiveness	10 to 150 Hz single amplitude 0.15 mm 3 directions, 8 strokes, 4 times
Ambient temperature range	Operation: 0 to 50 °C; Storage: -20 to 65 °C (with no icing or condensation)
Ambient humidity range	Operation and storage: 35 to 85%RH (with no condensation)
Ambient atmosphere	No corrosive gases
Material	Cable sheath: heat-resistant PVC Connector: PVC
Minimum bending radius	75 mm
Weight	Approx. 170 g

Cable Extension Unit

Model	FZ-VSJ
Power supply voltage *1	11.5 to 13.5 VDC
Current consumption *2	1.5 A max.
Ambient temperature range	Operating: 0 to 50 °C; Storage: -25 to 65 °C (with no icing or condensation)
Ambient humidity range	Operating and storage: 35 to 85% (with no condensation)
Maximum Units connectable	2 Units per Camera
Weight	Approx. 240 g
Accessories	Instruction Sheet and 4 mounting screws

*1 A 12-VDC power supply must be provided to the Cable Extension Unit when connecting the Intelligent Compact Camera, or the Lighting Controller.

*2 The current consumption shows when connecting the Cable Extension Unit to an external power supply.

Long-distance Camera Cables

Model	FZ-VS2 (15 m)	FZ-VSL2 (15 m)
Shock resistiveness (durability)	10 to 150 Hz single amplitude 0.15 mm 3 directions, 8 strokes, 4 times	
Ambient temperature range	Operation and storage: 0 to 65 °C (with no icing or condensation)	
Ambient humidity range	Operation and storage: 40 to 70%RH (with no condensation)	
Ambient atmosphere	No corrosive gases	
Material	Cable sheath, connector: PVC	
Minimum bending radius	93 mm	
Weight	Approx. 1600 g	

Parallel Cable

Model	FZ-VP	FZ-VPX
Vibration resistiveness	10 to 150 Hz single amplitude 0.15 mm 3 directions, 8 strokes, 4 times	
Ambient temperature range	Operation: 0 to 50 °C; Storage: -20 to 65 °C (with no icing or condensation)	
Ambient humidity range	Operation and storage: 35 to 85%RH (with no condensation)	
Ambient atmosphere	No corrosive gases	
Material	Cable sheath: heat-resistant PVC Connector: resin	
Minimum bending radius	75 mm	
Weight	Approx. 160 g	Approx. 180 g

Note: FZ-VP/FZ-VPX is only for the FZ series. The FH series can use XW2Z-S013-2/-S013-5.

Encoder Cable

Model	FH-VR
Vibration resistiveness	10 to 150 Hz single amplitude 0.1 mm 3 directions, 8 strokes, 10 times
Ambient temperature range	Operation: 0 to 50 °C; Storage: -10 to 60 °C (with no icing or condensation)
Ambient humidity range	Operation and storage: 35 to 85%RH (with no condensation)
Ambient atmosphere	No corrosive gases
Material	Cable Jacket: Heat, oil and flame resistant PVC Connector: polycarbonate resin
Minimum bending radius	65 mm
Weight	Approx. 104 g

FH-Series

Cameras / Cables Connection Table

Type of camera	Model	Cable length	High-speed CMOS cameras *						
			300,000-pixel	2 million-pixel		4 million-pixel		12 million-pixel	
			FH-SM/SC	FH-SM02/SC02		FH-SM04/SC04		FH-SM12/SC12	
			—	High speed mode of transmission speed select	Standard mode of transmission speed select	High speed mode of transmission speed select	Standard mode of transmission speed select	High speed mode of transmission speed select	Standard mode of transmission speed select
Camera Cables Right-angle camera cables	FZ-VS FZ-VSL	2 m	Yes	Yes	Yes	Yes	Yes	Yes	
		5 m	Yes	Yes	Yes	Yes	Yes	Yes	
		10 m	Yes	No	Yes	No	Yes	Yes	
Bend resistant camera cables	FZ-VSB	2 m	Yes	Yes	Yes	Yes	Yes	Yes	
		5 m	Yes	Yes	Yes	Yes	Yes	Yes	
		10 m	Yes	No	Yes	No	Yes	Yes	
Long-distance camera cable Long-distance right-angle camera cable	FZ-VS2 FZVSL2	15 m	Yes	No	Yes	No	Yes	No	Yes

* High-speed CMOS camera is only for the FH series.

Type of camera	Model	Cable length	Digital CCD cameras			Small digital CCD cameras Pen type / flat type	High-speed CCD cameras	Intelligent compact CMOS cameras
			300,000-pixel	2 million-pixel	5 million-pixel			
			FZ-S/SC	FZ-S2M/SC2M	FZ-S5M2/SC5M2			
Camera Cables Right-angle camera cables	FZ-VS FZ-VSL	2 m	Yes	Yes	Yes	Yes	Yes	Yes
		5 m	Yes	Yes	Yes	Yes	Yes	Yes
		10 m	Yes	Yes	No	Yes	Yes	Yes
Bend resistant camera cables	FZ-VSB	2 m	Yes	Yes	Yes	Yes	Yes	Yes
		5 m	Yes	Yes	Yes	Yes	Yes	Yes
		10 m	Yes	Yes	No	Yes	Yes	Yes
Long-distance camera cable Long-distance right-angle camera cable	FZ-VS2 FZVSL2	15 m	Yes	Yes	No	Yes	Yes	Yes

EtherCAT Communications Specifications

Item	Specifications	
Communications standard	IEC61158 Type 12	
Physical layer	100 BASE-TX (IEEE802.3)	
Modulation	Base band	
Baud rate	100 Mbps	
Topology	Depends on the specifications of the EtherCAT master.	
Transmission Media	Twisted-pair cable of category 5 or higher (double-shielded straight cable with aluminum tape and braiding)	
Transmission Distance	Distance between nodes: 100 m or less	
Node address setting	00 to 9	
External connection terminals	RJ45 × 2 (shielded) IN: EtherCAT input data, OUT: EtherCAT output data	
Send/receive PDO data sizes	Input	56 to 280 bytes/line (including input data, status, and unused areas) Up to 8 lines can be set. *
	Output	28 bytes/line (including output data and unused areas) Up to 8 lines can be set. *
Mailbox data size	Input	512 bytes
	Output	512 bytes
Mailbox	Emergency messages, SDO requests, and SDO information	
Refreshing methods	I/O-synchronized refreshing (DC)	

* This depends on the upper limit of the master.

Version Information

FH Series and Programming Devices

FH Series	Required Programming Device	
	Sysmac Studio Standard Edition/Vision Edition	
	Ver.1.06	Ver.1.07 or higher
FH-3050 (-□) FH-1050 (-□)	Not supported	Supported

Note: 1. The auto-update to Sysmac Studio version 1.07 will be available soon.
2. Sysmac Studio does not support the FZ5 Series.

Components and Functions

Example of the FH Sensor Controllers BOX type (4-camera type)

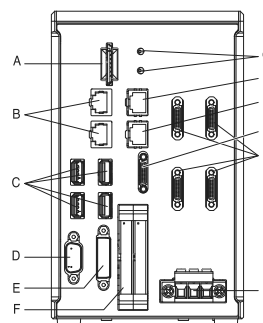
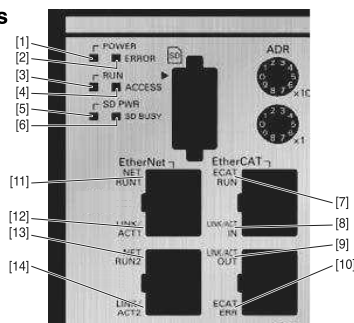

	Name	Description
[1]	POWER LED	Lit while power is ON.
[2]	ERROR LED	Lit when an error has occurred.
[3]	RUN LED	Lit while the controller is in Measurement Mode.
[4]	ACCESS LED	Lit while the memory is accessed.
[5]	SD POWER LED	Lit while power is supplied to the SD card and the card is usable.
[6]	SD BUSY LED	Blinks while the SD memory card is accessed.
[7]	EtherCAT RUN LED	Lit while EtherCAT communications are usable.
[8]	EtherCAT LINK/ACT IN LED	Lit when connected with an EtherCAT device, and blinks while performing communications.
[9]	EtherCAT LINK/ACT OUT LED	Lit when connected with an EtherCAT device, and blinks while performing communications.
[10]	EtherCAT ERR LED	Lit when EtherCAT communications have become abnormal.
[11]	EtherNet NET RUN1 LED	Lit while EtherNet communications are usable.
[12]	EtherNet NET LINK/ACK1 LED	Lit when connected with an EtherNet device, and blinks while performing communications.
[13]	EtherNet NET RUN2 LED	Lit when EtherNet communications are usable.
[14]	EtherNet NET LINK/ACK2 LED	Lit when connected with an EtherNet device, and blinks while performing communications.

	Name	Description
A	SD memory card installation connector	Install the SD memory card. Do not plug or unplug the SD card during measurement operation. Otherwise measurement time may be affected or data may be destroyed.
B	EtherNet connector	Connect an EtherNet device.
C	USB connector	Connect a USB device. Do not plug or unplug it during measurement operation. Otherwise measurement time may be affected or data may be destroyed.
D	RS-232C connector	Connect an external device such as a programmable controller.
E	DVI-I connector	Connect a monitor.
F	I/O connector (control lines, data lines)	Connect the controller to external devices such as a sync sensor and PLC.
G	EtherCAT address setup volume	Used to set a node address (00 to 99) as an EtherCAT communication device.
H	EtherCAT communication connector (IN)	Connect the opposed EtherCAT device.
I	EtherCAT communication connector (OUT)	Connect the opposed EtherCAT device.
J	Encoder connector	Connect an encoder.
K	Camera connector	Connect cameras.
L	Power supply terminal connector	Connect a DC power supply. Wire the controller independently on other devices. Wire the ground line. Be sure to ground the controller alone. Perform wiring using the attached power supply connector.

Example of the FZ5 Sensor Controllers LCD-integrated type (4-camera type)

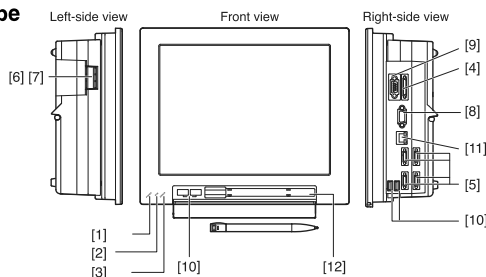

Example of the FZ5-Lite Sensor Controllers LCD-integrated type (4-camera type)

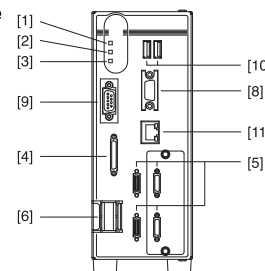

	Name	Description
[1]	POWER LED	Lit while power is ON.
[2]	RUN LED	Lit while the controller is in Run Mode.
[3]	ERROR LED	Lit when an error has occurred.
[4]	I/O connector (control lines, data lines)	Connect the controller to external devices such as a sync sensor and PLC.
[5]	Camera connector	Connect cameras.
[6]	Power	Connect a DC power supply. Wire the power supply unit independently of other devices. After wiring, replace the terminal cover.
[7]	Ground terminal	Connect the ground wire. Make sure that the controller is grounded with a separate ground wire.
[8]	Monitor connector (analog RGB)	Connect a monitor. (Provided with Lite controller type only)
[9]	RS-232C/RS-422 connector	Connect an external device such as a personal computer or PLC.
[10]	USB connector	Connect a track ball, mouse and USB memory. A total of four USB ports are provided and any of them can be used. However, when connecting two or more USB memories, do not connect them to adjacent ports. Doing so may cause the USB memories to come into contact, resulting in malfunction or damage.
[11]	EtherNet connector	Connect the controller to a personal computer.
[12]	Touch pen (holder)	A touch pen is stored. (Provided with the LCD integrated type only)

Processing Items

Group	Icon	Processing Item	Corresponding Page in the Catalog
Measurement		Search Used to identify the shapes and calculate the position of measurement objects.	P16
		Flexible Search Recognizing the shapes of workpieces with variation and detecting their positions.	P16
		Sensitive Search Search a small difference by dividing the search model in detail, and calculating the correlation.	P16
		ECM Search Used to search the similar part of model from input image. Detect the evaluation value and position.	
		EC Circle Search Extract circles using "round " shape information and get position, radius and quantity in high preciseness.	
		Shape Search II Used to search the similar part of model from input image regardless of environmental changes. Detect the evaluation value and position.	P16
		Shape Search III Robust detection of positions is possible at high-speed and with high precision incorporating environmental fluctuations, such as differences in individual shapes of the workpieces, pose fluctuations, noise superimposition and shielding.	P16
		EC Corner This processing item measures a corner position (corner) of a workpiece.	
		Ec Cross The center position of a crosshair shape is measured using the lines created by the edge information on each side of the crosshair.	
		Classification Used when various kinds of products on the assembly line need to be sorted and identified.	P16
		Edge Position Measure position of measurement objects according to the color change in measurement area.	P16
		Edge Pitch Detect edges by color change in measurement area. Used for calculating number of pins of IC and connectors.	P16
		Scan Edge Position Measure peak/bottom edge position of workpieces according to the color change in separated measurement area.	P16
		Scan Edge Width Measure max/min/average width of workpieces according to the color change in separated measurement area.	P16
		Circular Scan Edge Position Measure center axis, diameter and radius of circular workpieces.	P16
		Circular Scan Edge Width Measure center axis, width and thickness of ring workpieces.	P16
		Intersection Calculate approximate lines from the edge information on two sides of a square workpiece to measure the angle formed at the intersection of the two lines.	P16
		Color Data Used for detecting presence and mixed varieties of products by using color average and deviation.	
		Gravity and Area Used to measure area, center of gravity of workpieces by extracting the color to be measured.	
		Labeling Used to measure number, area and gravity of workpieces by extracting registered color.	
		Label Data Selecting one region of extracted Labeling, and get that measurement. Area and Gravity position can be got and judged.	
		Defect Used for appearance measurement of plain-color measurement objects such as defects, stains and burrs.	P16
		Precise Defect Check the defect on the object. Parameters for extraction defect can be set precisely.	P16
		Fine Matching Difference can be detected by overlapping and comparing (matching) registered fine images with input images.	P16
		Character Inspect Recognize character according correlation search with model image registered in [Model Dictionary].	P17
		Date Verification Reading character string is verified with internal date.	P17
		Model Dictionary Register character pattern as dictionary. The pattern is used in [Character Inspection].	
		2DCode *2 Recognize 2D code and display where the code quality is poor.	P17
		Barcode *1 Recognize barcode, verify and output decoded characters.	P17
		OCR Recognize and read characters in images as character information.	P17
		OCR User Dictionary Register dictionary data to use for OCR.	P17
		Circle Angle Used for calculating angle of inclination of circular measurement objects.	
	Glue Bead Inspection You can inspect coating of a specified color for gaps or runoffs along the coating path.	P17	
Input Image		Camera Image Input To input images from cameras. And set up the conditions to input images from cameras. (To FZ5 Sensor Controllers only)	
		Camera Image Input FH To input images from cameras. And set up the conditions to input images from cameras. (For FH Sensor Controllers only)	

Group	Icon	Processing Item	Corresponding Page in the Catalog
Input Image		Camera Image Input HDR Create high-dynamic range images by acquiring several images with different conditions.	
		Camera Image Input HDR Lite HDR function for FZ-SQ□ Intelligent Compact Cameras.	
		Camera Switch To switch the cameras used for measurement. Not input images from cameras again.	
		Measurement Image Switching To switch the images used for measurement. Not input images from camera again.	
		Position Compensation Used when positions are differed. Correct measurement is performed by correcting position of input images.	P18
		Filtering Used for processing images input from cameras in order to make them easier to be measured.	P18
		Background Suppression To enhance contrast of images by extracting color in specified brightness.	P18
		Brightness Correct Filter Track brightness change of entire screen and remove gradual brightness change such as uneven brightness.	P18
		Color Gray Filter Color image is converted into monochrome images to emphasize specific color.	P18
		Extract Color Filter Convert color image to color extracted image or binary image.	P18
Compensate image		Anti Color Shading To remove the irregular color/pattern by uniformizing max.2 specified colors.	P18
		Stripes Removal Filter II Remove the background pattern of vertical, horizontal and diagonal stripes.	P19
		Polar Transformation Rectify the image by polar transformation. Useful for OCR or pattern inspection printed on circle.	P18
		Trapezoidal Correction Rectify the trapezoidal deformed image.	P18
		Machine Simulator How the alignment marks would move on the image when each stage or robot axis is controlled can be checked.	
		Image Subtraction The registered model image and measurement image are compared and only the different pixels are extracted and converted to an image.	
		Advanced filter Process the images acquired from cameras in order to make them easier to measure. This processing item consolidates existing image conversion filtering into one processing item and adds extra functions.	P18
		Panorama Combine multiple image to create one big image.	P18
		Unit Macro Advanced arithmetic processing can be easily incorporated into workflow as Unit Macro processing items.	P20
		Unit Calculation Macro This function is convenient when the user wants to calculate a value using an original calculation formula or change the set value or system data of a processing item.	P20
Support measurement		Calculation Used when using the judge results and measured values of Procltem which are registered in processing units.	
		Line Regression Used for calculating regression line from plural measurement coordinate.	
		Circle Regression Used for calculating regression circle from plural measurement coordinate.	
		Precise Calibration Used for calibration corresponding to trapezoidal distortion and lens distortion.	P15
		User Data Used for setting of the data that can be used as common constants and variables in scene group data.	P21
		Set Unit Data Used to change the Procltem data (setting parameters, etc.) that has been set up in a scene.	
		Get Unit Data Used to get one data (measured results, setting parameters, etc.) of Procltem that has been set up in a scene.	
		Set Unit Figure Used for re-setting the figure data (model, measurement area) registered in an unit.	
		Get Unit Figure Used for get the figure data (model, measurement area) registered in an unit.	
		Trend Monitor Used for displaying the information about results on the monitor, facilitating to avoid NG and analyze causes.	P21
	Image Logging Used for saving the measurement images to the memory and USB memory.		
	Image Conversion Logging Used for saving the measurement images in JPEG and BMP format.		
	Data Logging Used for saving the measurement data to the memory and USB memory.		
	Elapsed Time Used for calculating the elapsed time since the measurement trigger input.		
	Wait Processing is stopped only at the set time. The standby time is set by the unit of [ms].		

Group	Icon	Processing Item	Corresponding Page in the Catalog
Support measurement		Focus Focus setting is supported.	P15
		Iris Focus and aperture setting is supported.	P15
		Parallelize*3 A part of the measurement flow is divided into two or more tasks and processed in parallel to shorten the measurement time. This processing item is placed at the top of processing to be performed in parallel.	
		Parallelize Task*3 A part of the measurement flow is divided into two or more tasks and processed in parallel to shorten the measurement time. This processing item is placed immediately before processing to be performed in parallel between Parallelize and Parallelize End.	
		Statistics Used when you need to calculate an average of multiple measurement results.	
		Reference Calib Data Calibration data and distortion compensation data held under other processing items can be referenced.	
		Position Data Calculation The specified position angle is calculated from the measured positions.	P14
		Stage Data Sets and stores data related to stages.	
		Robot Data Sets and stores data related to robots.	
		Vision Master Calibration This processing item automatically calculates the entire axis movement amount of the control equipment necessary for calibration.	P15
		PLC Master Calibration Calibration data is created using a communication command from PLC.	P15
		Convert Position Data The position angle after the specified axis movement is calculated.	P14
		Movement Single Position The axis movement that is required to match the measured position angle to the reference position angle is calculated.	P14
		Movement Multi Points The axis movements that are required to match the measured position angles to the corresponding reference position angles are calculated.	P14
		Detection Point Obtains position/angle information by referring to the coordinate values measured with the Measurement Processing Unit.	
		Camera Calibration By setting the camera calibration, the measurement result can be converted and output as actual dimensions.	P15
		Data Save The set data can be saved in the controller main unit or as scene data. The data is held even after the FH/FZ power is turned off.	

Group	Icon	Processing Item	Corresponding Page in the Catalog
Branch		Conditional Branch Used where more than two kinds of products on the production line need to be detected separately.	
		End This Proctem must be set up as the last processing unit of a branch.	
		DI Branch Same as Proctem "Branch". But you can change the targets of conditional branching via external inputs.	
		Control Flow Normal Set the measurement flow processing into the wait state in which the specific no-protocol command can be executed.	
		Control Flow PLC Link Set the measurement flow processing into the wait state in which the specific PLC Link command can be executed.	
		Control Flow Parallel Set the measurement flow processing into the wait state in which the specific parallel command can be executed.	
		Control Flow Fieldbus Set the measurement flow processing into the wait state in which the specific Fieldbus command can be executed.	
		Selective Branch Easily branch to multiple destinations.	
Output results		Data Output Used when you need to output data to the external devices such as PLC or PC via serial ports.	
		Parallel Data Output Used when you need to output data to the external devices such as PLC or PC via parallel ports.	
		Parallel Judgement Output Used when you need to output judgement results to the external devices such as PLC or PC via parallel ports.	
		Fieldbus Data Output Outputs data to an external device, such as a Programmable Controller, through a fieldbus interface.	
Output result		Result Display Used for displaying the texts or the figures in the camera image.	
		Display Image File Display selected image file.	
		Display Last NG Image Display the last NG images.	

*1 Bar Codes that can be read : JAN/EAN/UPC (including add-on codes), Code 39, Codabar (NW-7), ITF (Interleaved 2 of 5), Code 93, Code 128, GS1-128, GS1 DataBar (RSS-14 / RSS Limited / RSS Expanded), Pharmacode
 *2 2D Codes that can be read : Data Matrix (ECC200), QR Code
 *3 FZ5-L3□□/6□□ controllers do not support.

Dimensions

(Unit: mm)

Sensor Controllers

FH-series Box-type
 FH-3050/-3050-10/-3050-20
 FH-1050/-1050-10/-1050-20

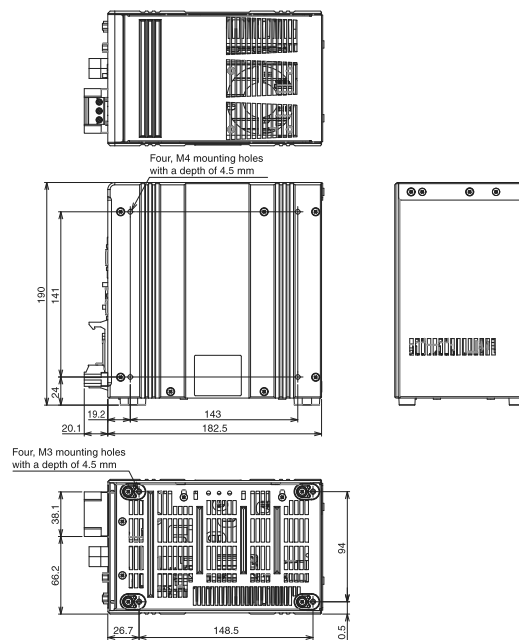
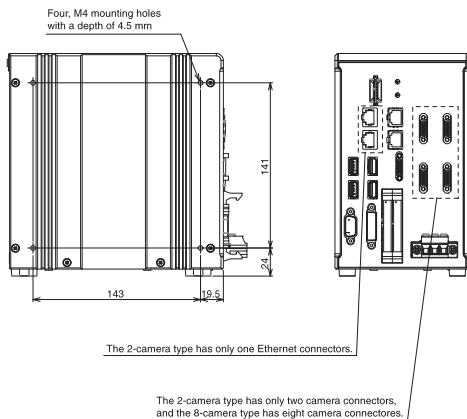

FH-Series

FZ5-series LCD-integrated type FZ5-1100/-1105/-1100-10/1105-10 FZ5-600/-605/-600-10/-605-10

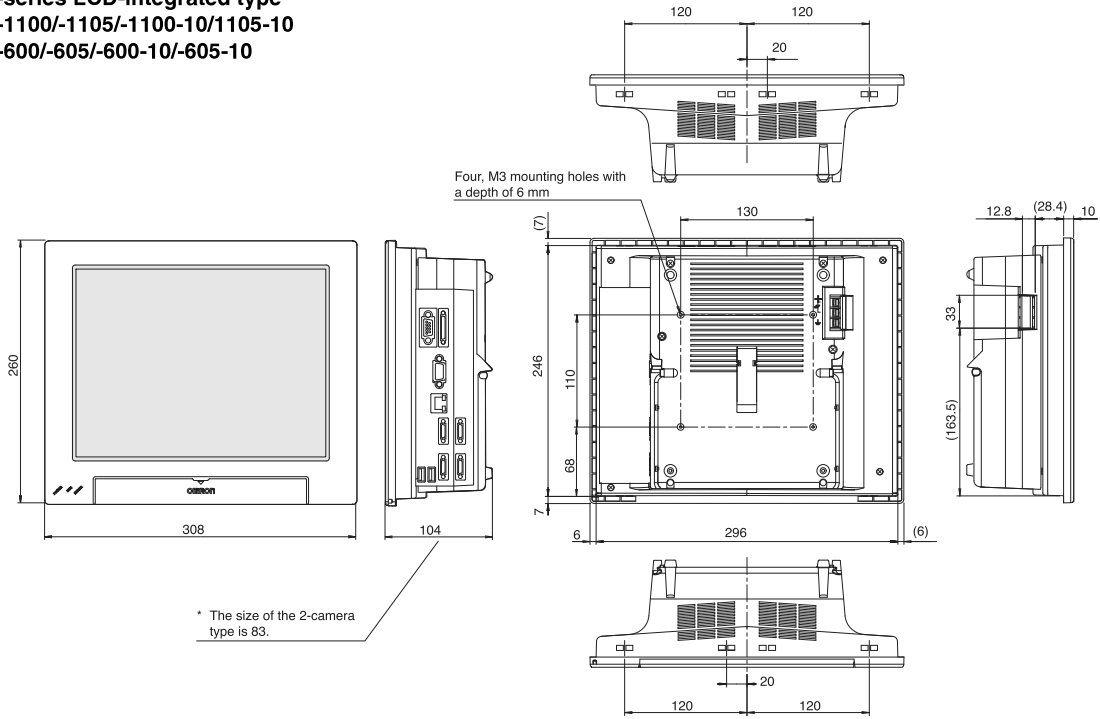

FZ5-series Lite Box-type FZ5-L350/-L355/-L350-10/-L355-10

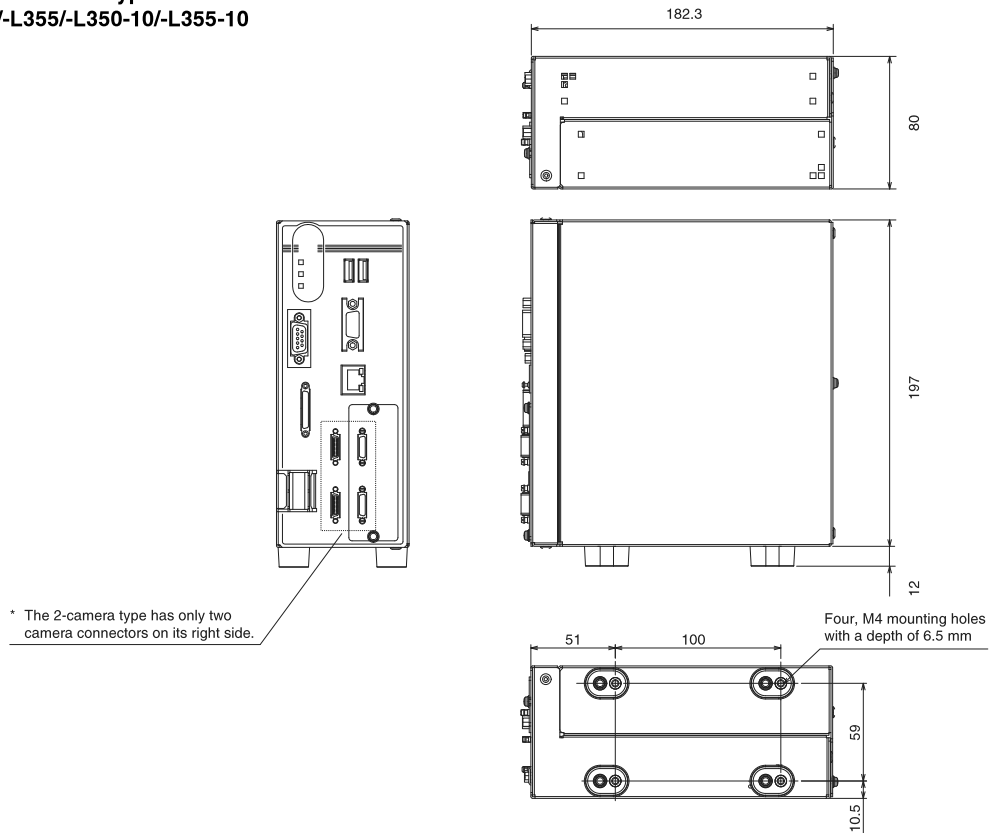

Cameras

High-speed CMOS Camera

300,000-pixel camera

FH-SC
FH-SM

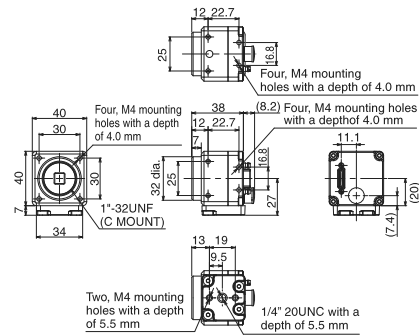

2 million-pixel camera

FH-SC02
FH-SM02

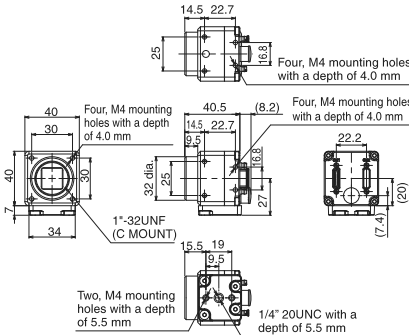

4 million-pixel camera

FH-SC04
FH-SM04

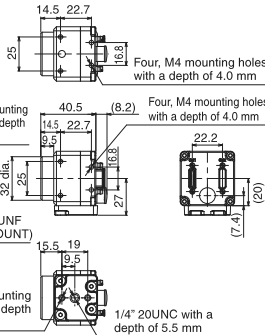

12 million-pixel camera

FH-SC12
FH-SM12

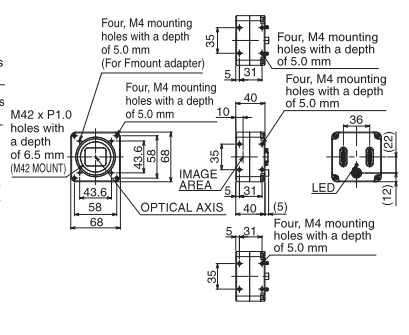

Digital CCD Cameras

300,000-pixel camera

FZ-S
FZ-SC

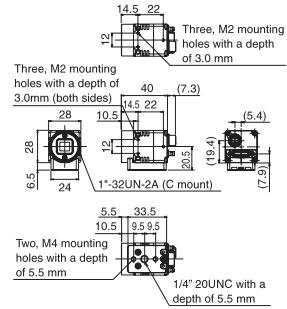

2 million-pixel camera

FZ-S2M
FZ-SC2M

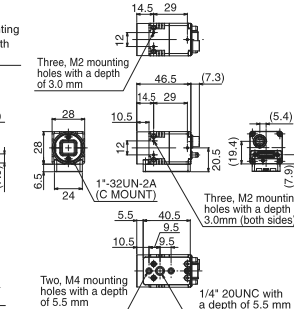

5 million-pixel camera

FZ-S5M2
FZ-SC5M2

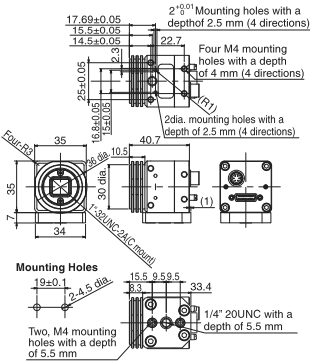

High-speed CCD Camera

FZ-SH
FZ-SHC

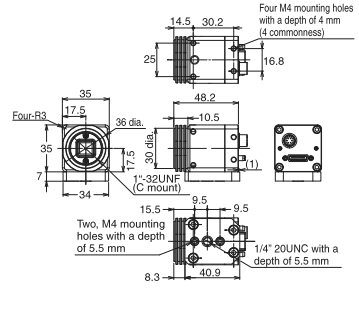

Small digital CCD cameras

Camera head

Flat camera
FZ-SF
FZ-SFC

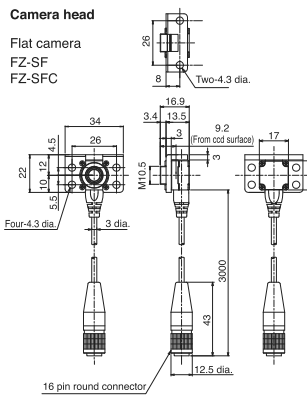

Pen-shaped camera

FZ-SP
FZ-SPC

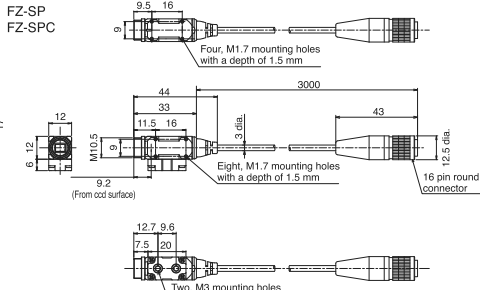

Camera amplifier

Can be used for both flat cameras and pen-shaped cameras

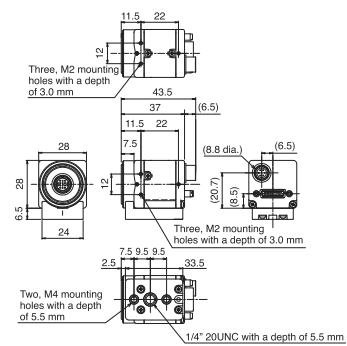

Intelligent Compact CMOS Cameras

Narrow view / Standard
FZ-SQ010F
FZ-SQ050F

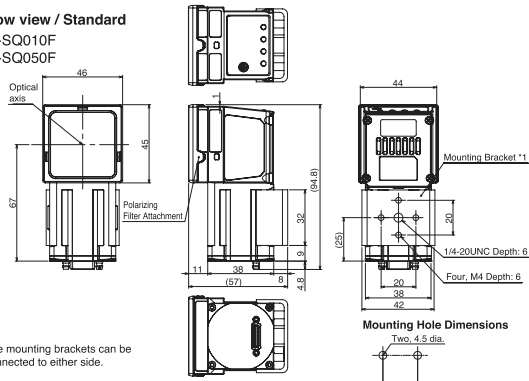

*1. The mounting brackets can be connected to either side.

Mounting Hole Dimensions

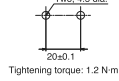

Wide View
FZ-SQ100F (long-distance)
FZ-SQ100N (short-distance)

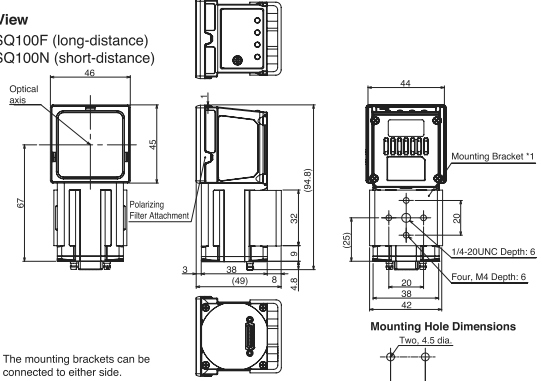

*1. The mounting brackets can be connected to either side.

Mounting Hole Dimensions

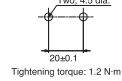

Cables

Camera Cable

Camera Cable
FZ-VS

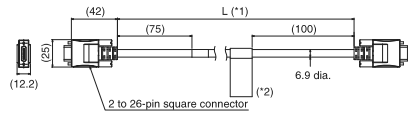

Long-distance Camera Cable
FZ-VS2

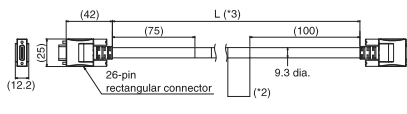

Bend resistant Cable
FZ-VSB

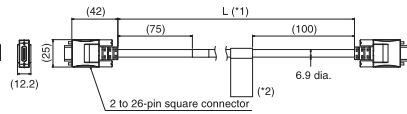

Long-distance Right-angle Camera Cable
FZ-VSL2

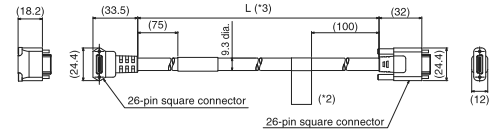

Right-angle Camera Cable
FZ-VSL

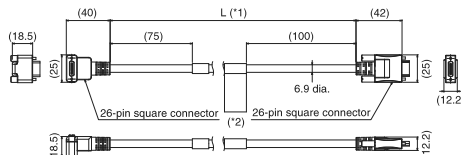

*1. Cable is available in 2m/5m/10m.
*2. Each camera cables has polarity. Please ensure that the name plate side of the cable is connected to the controller.
*3. Cable is available in 15m.

Parallel Cable

FZ-VP

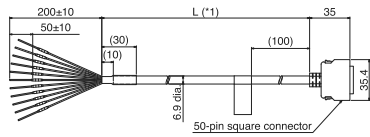

*1. cable is available in 2m/5m.

FZ-VPX

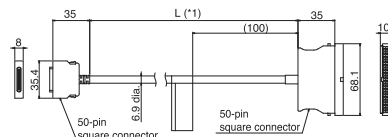

*1. cable is available in 2m/5m.

Monitor Cable

FZ-VM

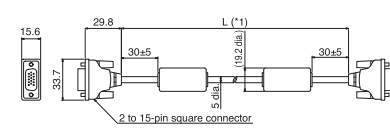

*1. cable is available in 2m/5m.

Encoder Cable

FH-VR

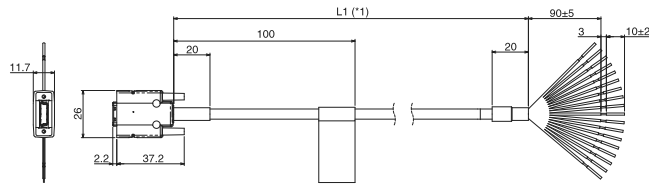

*1. Cable is available in 1.5 m.

LCD Monitor

FZ-M08

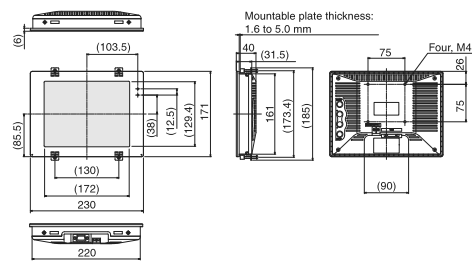

Camera Cable Extension Unit

FZ-VSJ

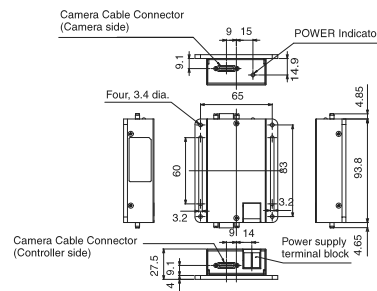

Extension Tubes for Small Camera

FZ-LESR

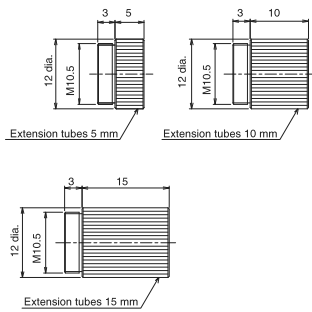

Lens for Small Camera

FZ-LES Series

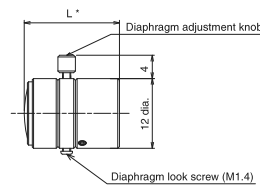

* Overall length is available in 16.4mm/19.7mm/23.1mm/25.5mm.

FH-Series

Optical Chart

High-speed CMOS Camera FH-S□12, 12 million-pixel

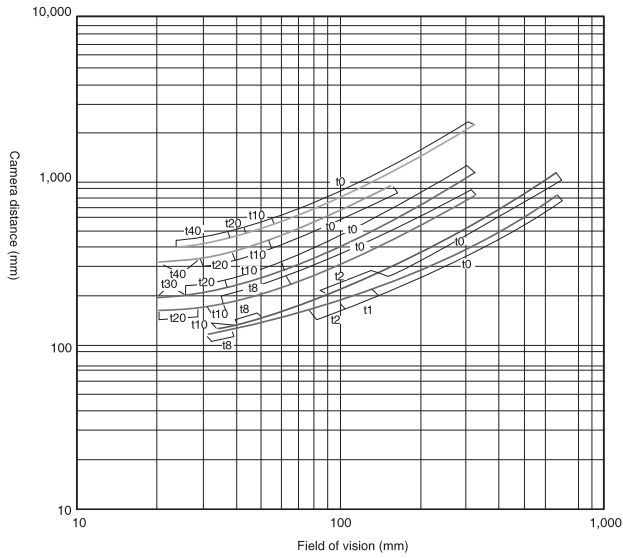

- 3Z4S-LE
- VS-L1828/M42-10
 - VS-L2526/M42-10
 - VS-L3528/M42-10
 - VS-L5028/M42-10
 - VS-L8540/M42-10
 - VS-L10028/M42-10

High-speed CMOS Camera FH-S□04, 4 million-pixel

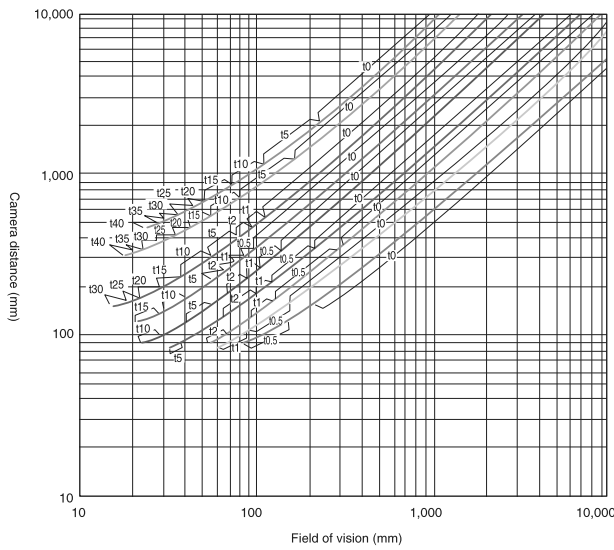

- 3Z4S-LE
- VS-0618H1
 - VS-0814H1
 - VS-1214H1
 - VS-1614H1
 - VS-2514H1
 - VS-3514H1
 - VS-5018H1
 - SV-7525H
 - SV-10028H

High-speed CMOS Camera FH-S□02, 2 million-pixel

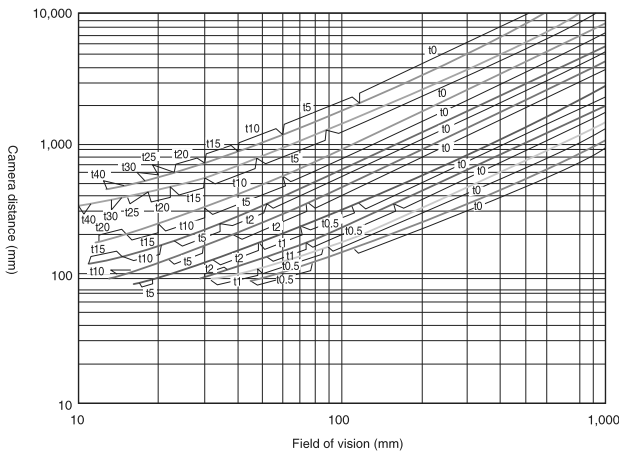

- 3Z4S-LE
- VS-0618H1
 - VS-0814H1
 - VS-1214H1
 - VS-1614H1
 - VS-2514H1
 - VS-3514H1
 - VS-5014H1
 - SV-7525H
 - SV-10028H

High-speed CMOS Camera FH-S□, High-speed CCD Camera FZ-SH□, Digital CCD Camera FZ-S□
300,000-pixel

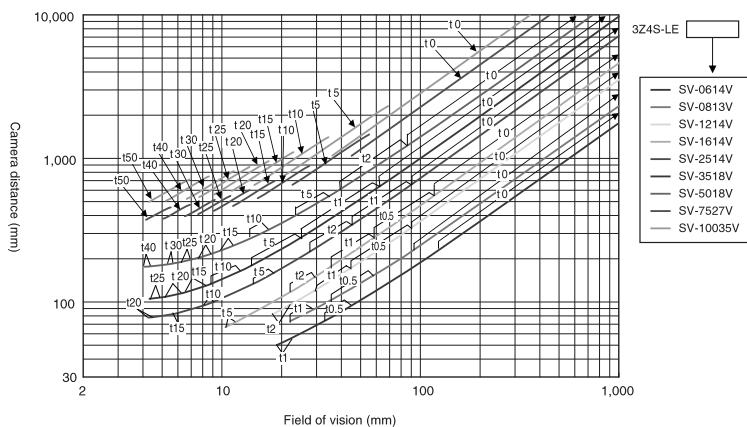

Digital CCD Camera FZ-S□5M2, 5 million-pixel

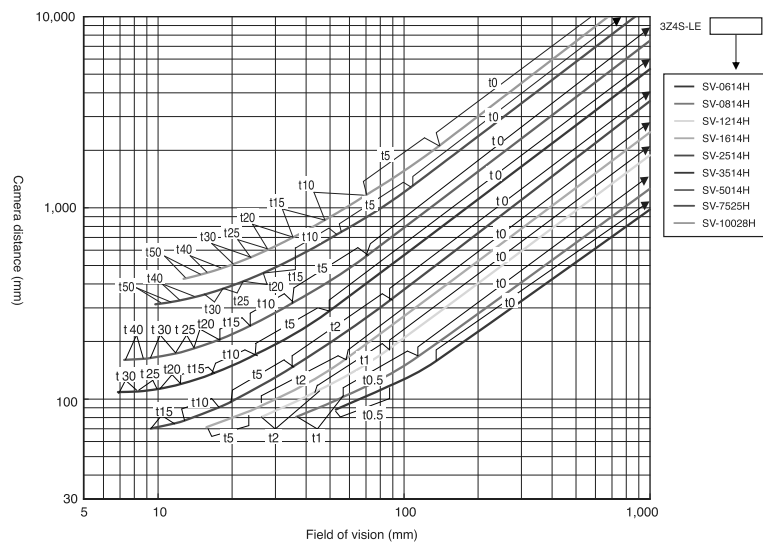

Digital CCD Camera FZ-S□2M, 2 million-pixel

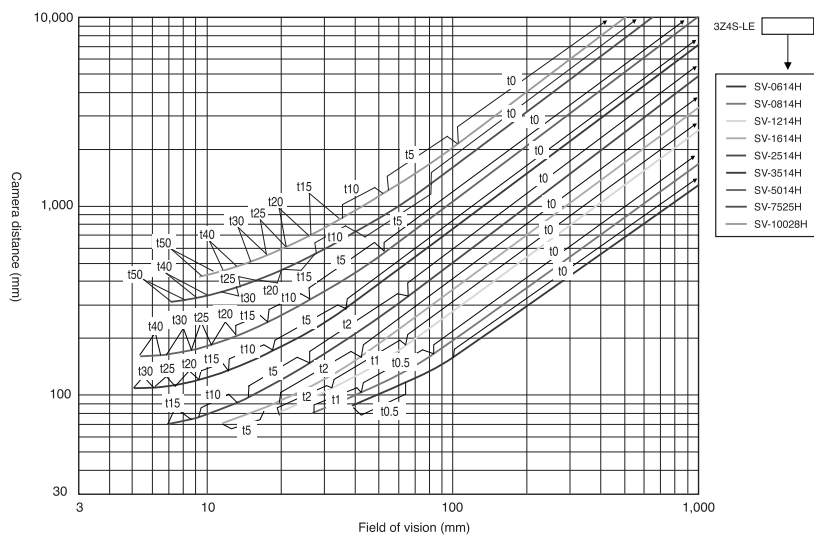

FH-Series

Small Digital CCD Cameras FZ-SF□, FZ-SP□, 300,000-pixel

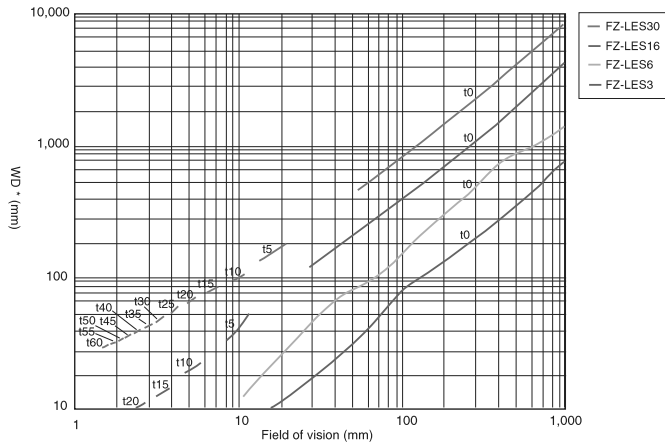

* The vertical axis represents WD, not installation distance.

High-speed CMOS Camera FH-S□, High-speed CCD Camera FZ-SH□, Digital CCD Camera FZ-S□ 300,000-pixel (Vibrations and shocks resistant)

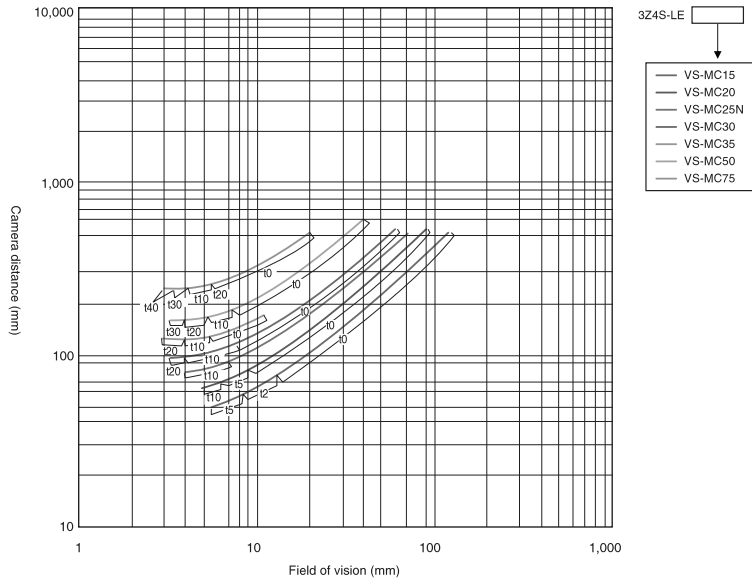

**Digital CCD Camera FZ-S□5M2, 5 million-pixel
(Vibrations and shocks resistant)**

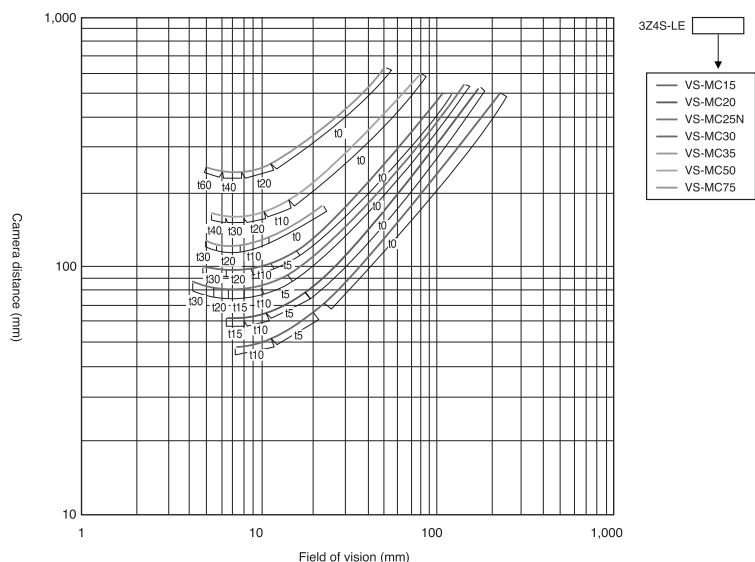

**Digital CCD Camera FZ-S□2M, 2 million-pixel
(Vibrations and shocks resistant)**

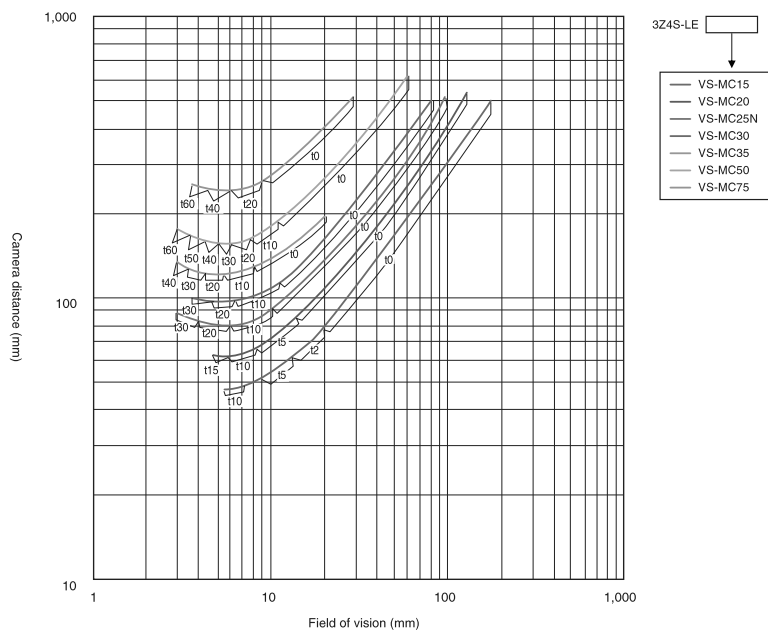

Meaning of Optical Chart

The X axis of the optical chart shows the field of vision (mm) (*1), and the Y axis of the optical chart shows the camera installation distance (mm) (*2).

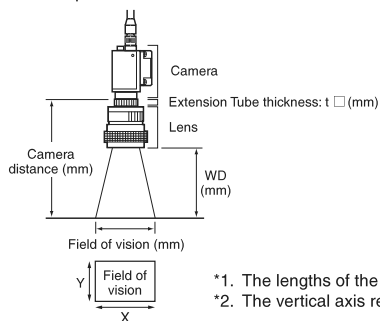

*1. The lengths of the fields of vision given in the optical charts are the lengths of the Y axis.
*2. The vertical axis represents WD for small cameras.

FH-Series

Intelligent Compact Cameras

- **Narrow View**
FZ-SQ010F

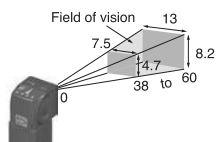

- **Standard**
FZ-SQ050F

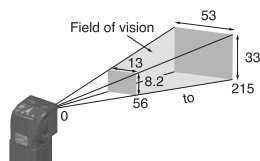

- **Wide View (Long-distance)**
FZ-SQ100F

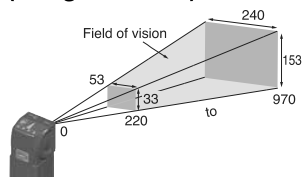

- **Wide View (Short-distance)**
FZ-SQ100N

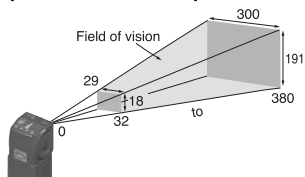

Related Manuals

Man.No.	Model number	Manual
Z340	FH/FZ5	Vision System FH/FZ5 Series User's Manual
Z341	FH/FZ5	Vision System FH/FZ5 Series Processing Item Function Reference Manual
Z342	FH/FZ5	Vision System FH/FZ5 Series User's Manual for Communications Settings
Z343	FH	Vision System FH Series Operation Manual for Sysmac Studio

Terms and Conditions Agreement

Read and understand this catalog.

Please read and understand this catalog before purchasing the products. Please consult your OMRON representative if you have any questions or comments.

Warranties.

- (a) Exclusive Warranty. Omron's exclusive warranty is that the Products will be free from defects in materials and workmanship for a period of twelve months from the date of sale by Omron (or such other period expressed in writing by Omron). Omron disclaims all other warranties, express or implied.
- (b) Limitations. OMRON MAKES NO WARRANTY OR REPRESENTATION, EXPRESS OR IMPLIED, ABOUT NON-INFRINGEMENT, MERCHANTABILITY OR FITNESS FOR A PARTICULAR PURPOSE OF THE PRODUCTS. BUYER ACKNOWLEDGES THAT IT ALONE HAS DETERMINED THAT THE PRODUCTS WILL SUITABLY MEET THE REQUIREMENTS OF THEIR INTENDED USE.

Omron further disclaims all warranties and responsibility of any type for claims or expenses based on infringement by the Products or otherwise of any intellectual property right. (c) Buyer Remedy. Omron's sole obligation hereunder shall be, at Omron's election, to (i) replace (in the form originally shipped with Buyer responsible for labor charges for removal or replacement thereof) the non-complying Product, (ii) repair the non-complying Product, or (iii) repay or credit Buyer an amount equal to the purchase price of the non-complying Product; provided that in no event shall Omron be responsible for warranty, repair, indemnity or any other claims or expenses regarding the Products unless Omron's analysis confirms that the Products were properly handled, stored, installed and maintained and not subject to contamination, abuse, misuse or inappropriate modification. Return of any Products by Buyer must be approved in writing by Omron before shipment. Omron Companies shall not be liable for the suitability or unsuitability or the results from the use of Products in combination with any electrical or electronic components, circuits, system assemblies or any other materials or substances or environments. Any advice, recommendations or information given orally or in writing, are not to be construed as an amendment or addition to the above warranty.

See <http://www.omron.com/global/> or contact your Omron representative for published information.

Limitation on Liability; Etc.

OMRON COMPANIES SHALL NOT BE LIABLE FOR SPECIAL, INDIRECT, INCIDENTAL, OR CONSEQUENTIAL DAMAGES, LOSS OF PROFITS OR PRODUCTION OR COMMERCIAL LOSS IN ANY WAY CONNECTED WITH THE PRODUCTS, WHETHER SUCH CLAIM IS BASED IN CONTRACT, WARRANTY, NEGLIGENCE OR STRICT LIABILITY.

Further, in no event shall liability of Omron Companies exceed the individual price of the Product on which liability is asserted.

Suitability of Use.

Omron Companies shall not be responsible for conformity with any standards, codes or regulations which apply to the combination of the Product in the Buyer's application or use of the Product. At Buyer's request, Omron will provide applicable third party certification documents identifying ratings and limitations of use which apply to the Product. This information by itself is not sufficient for a complete determination of the suitability of the Product in combination with the end product, machine, system, or other application or use. Buyer shall be solely responsible for determining appropriateness of the particular Product with respect to Buyer's application, product or system. Buyer shall take application responsibility in all cases.

NEVER USE THE PRODUCT FOR AN APPLICATION INVOLVING SERIOUS RISK TO LIFE OR PROPERTY OR IN LARGE QUANTITIES WITHOUT ENSURING THAT THE SYSTEM AS A WHOLE HAS BEEN DESIGNED TO ADDRESS THE RISKS, AND THAT THE OMRON PRODUCT(S) IS PROPERLY RATED AND INSTALLED FOR THE INTENDED USE WITHIN THE OVERALL EQUIPMENT OR SYSTEM.

Programmable Products.

Omron Companies shall not be responsible for the user's programming of a programmable Product, or any consequence thereof.

Performance Data.

Data presented in Omron Company websites, catalogs and other materials is provided as a guide for the user in determining suitability and does not constitute a warranty. It may represent the result of Omron's test conditions, and the user must correlate it to actual application requirements. Actual performance is subject to the Omron's Warranty and Limitations of Liability.

Change in Specifications.

Product specifications and accessories may be changed at any time based on improvements and other reasons. It is our practice to change part numbers when published ratings or features are changed, or when significant construction changes are made. However, some specifications of the Product may be changed without any notice. When in doubt, special part numbers may be assigned to fix or establish key specifications for your application. Please consult with your Omron's representative at any time to confirm actual specifications of purchased Product.

Errors and Omissions.

Information presented by Omron Companies has been checked and is believed to be accurate; however, no responsibility is assumed for clerical, typographical or proofreading errors or omissions.

Note: Do not use this document to operate the Unit.

OMRON Corporation Industrial Automation Company
Tokyo, JAPAN

Contact: www.ia.omron.com

Regional Headquarters

OMRON EUROPE B.V.

Sensor Business Unit

Carl-Benz-Str. 4, D-71154 Nufringen, Germany
Tel: (49) 7032-811-0/Fax: (49) 7032-811-199

OMRON ASIA PACIFIC PTE. LTD.

No. 438A Alexandra Road # 05-05/08 (Lobby 2),
Alexandra Technopark,
Singapore 119967
Tel: (65) 6835-3011/Fax: (65) 6835-2711

OMRON ELECTRONICS LLC

One Commerce Drive Schaumburg,
IL 60173-5302 U.S.A.
Tel: (1) 847-843-7900/Fax: (1) 847-843-7787

OMRON (CHINA) CO., LTD.

Room 2211, Bank of China Tower,
200 Yin Cheng Zhong Road,
PuDong New Area, Shanghai, 200120, China
Tel: (86) 21-5037-2222/Fax: (86) 21-5037-2200

Authorized Distributor:

© OMRON Corporation 2013-2014 All Rights Reserved.
In the interest of product improvement,
specifications are subject to change without notice.

CSM_4_1_0114
Cat. No. Q197-E1-02

0114 (0613)