

POLITECNICO DI MILANO  
FACOLTÀ DI INGEGNERIA EDILE - ARCHITETTURA  
MASTER IN ARCHITECTURAL ENGINEERING  
2013 - 2015



# EASTERN METROPOLITAN GREEN LUNG

Consuelo Concepción Velazco Sánchez 814744  
Fabio Andrés Ríos Franco 819782





TO QUERETARO  
217 KM

TO PACHUCA  
90.9 KM

TO TEXCOCO  
33.3 KM

TO PUEBLA  
132 KM

TO TOLUCA  
65 KM

TLALNEPANTLA

CIUDAD SATELITE

NAUCALPAN DE JUAREZ

AZCAPOTZALCO

GUSTAVO A. MADERA

MIGUEL HIDALGO

VENUSTIANO CARRANZA

CIUDAD NEZAHUALCÓYOTL

QUAJIMALPA DE MORELOS

ALVARO OBREGON

IZTAPAL

BENITO JUAREZ

IZTAPALAPA

COYOACAN

TLÁHUAC

LA MAGDALENA CONTRERAS

TLALPAN

XOCHIMILCO

MILPA ALTA

### LEGENDS

- URBAEASTERN METROPOLITAN GREEN LUNG
- URBAN STRUCTURE**
- FEDERAL BORDERS
- ..... DELEGATION BOUNDARY
- HISTORIC CENTER
- MOBILITY**
- CIRCUITS
- MAIN CONNECTIONS
- ROAD CORRIDORS
- COMMUTER TRAIN
- METRO LINES
- METRO STOP
- METROBUS LINES
- METROBUS STOP
- MAIN BUS STATIONS
- AREA OF ECOLOGICAL VALUE**
- GREEN AREAS
- WATER BODIES
- FEDERAL AREA TEXCOCO LAKE
- FACILITIES**
- FUTURE AIRPORT
- PUBLIC EDUCATIONAL INSTITUTIONS

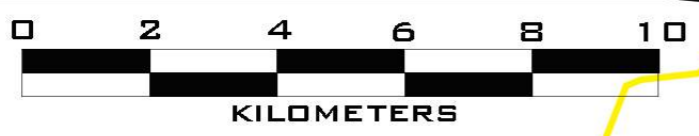

TO CUERNAVACA



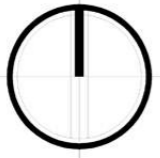

TO QUERETARO  
217 KM

TO PACHUCA  
90.9 KM

CIRCUITO EXTE.  
RÍO MEXIQUENSE

TEXCOCO  
33.3 KM

TO TOLUCA  
65 KM

TO PUEBLA  
132 KM

### LEGEND

 EASTERN METROPOLITAN GREEN LUNG

#### URBAN STRUCTURE

 FEDERAL BORDERS

 URBAN AREA

 HISTORIC CENTER

#### MOBILITY

 CIRCUITS

 MAIN CONNECTIONS

 COMMUTER TRAIN

 STOPS

 MAIN BUS STATIONS

#### AREA OF ECOLOGICAL VALUE

 GREEN AREA

 WATER BODIES

 FEDERAL AREA OF

TEXCOCO LAKE

#### FACILITIES

 FUTURE AIRPORT

 PUBLIC EDUCATIONAL

INSTITUTION



TO CUERNAVACA  
86.2 KM



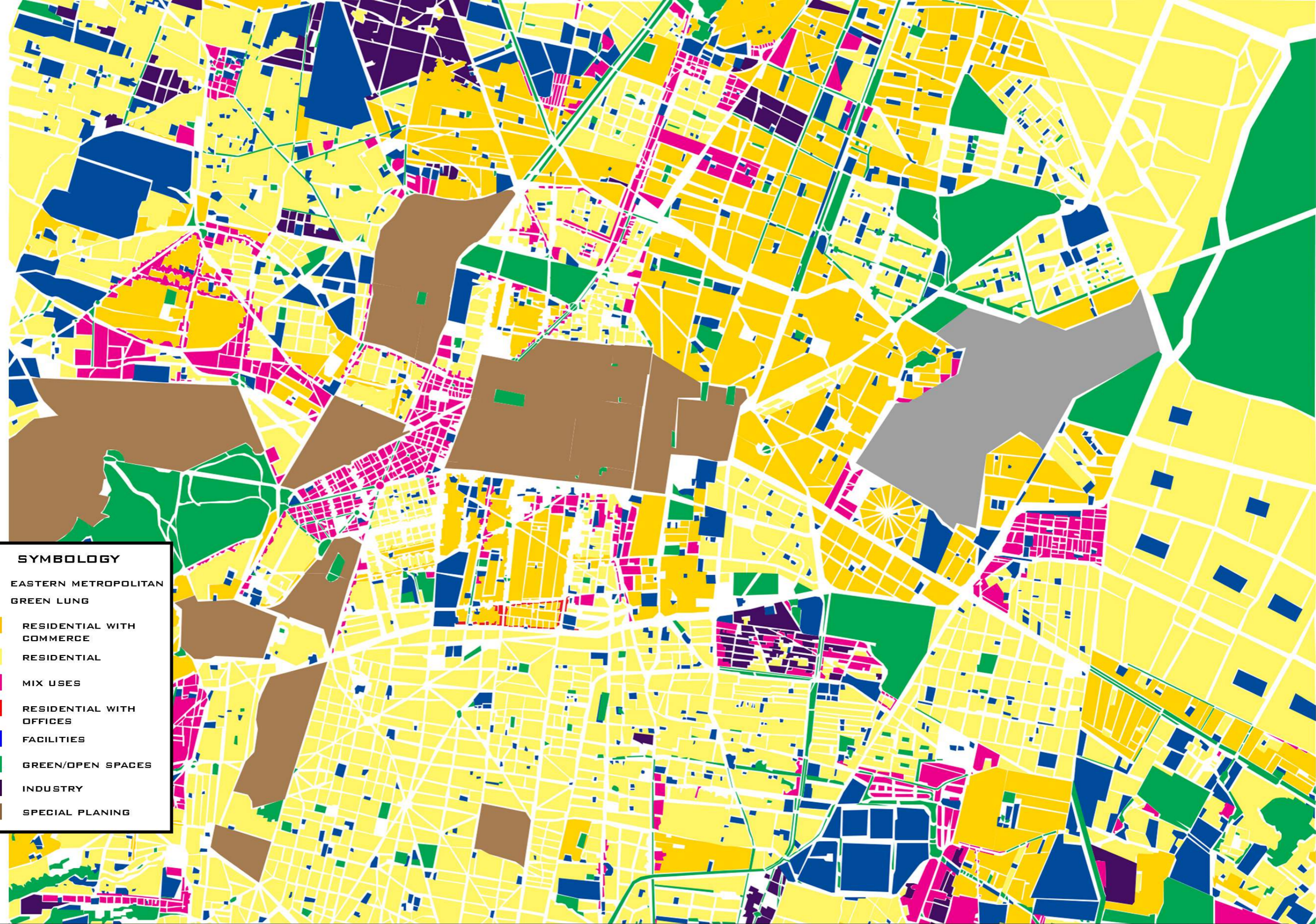
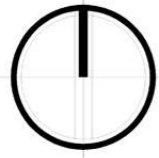

**SYMBOLY**

- EASTERN METROPOLITAN GREEN LUNG
- RESIDENTIAL WITH COMMERCE
- RESIDENTIAL
- MIX USES
- RESIDENTIAL WITH OFFICES
- FACILITIES
- GREEN/OPEN SPACES
- INDUSTRY
- SPECIAL PLANING



**POLITECNICO DI MILANO**  
**FACOLTÀ DI INGEGNERIA EDILE - ARCHITETTURA**  
**MASTER IN ARCHITECTURAL ENGINEERING**  
2013 - 2015

### **EASTERN METROPOLITAN GREEN LUNG**

Consuelo Concepción Velazco Sánchez 814744  
Fabio Andrés Ríos Franco 819782

Content:  
**Land Use**  
Scale:  
**S/E**

**U-03**

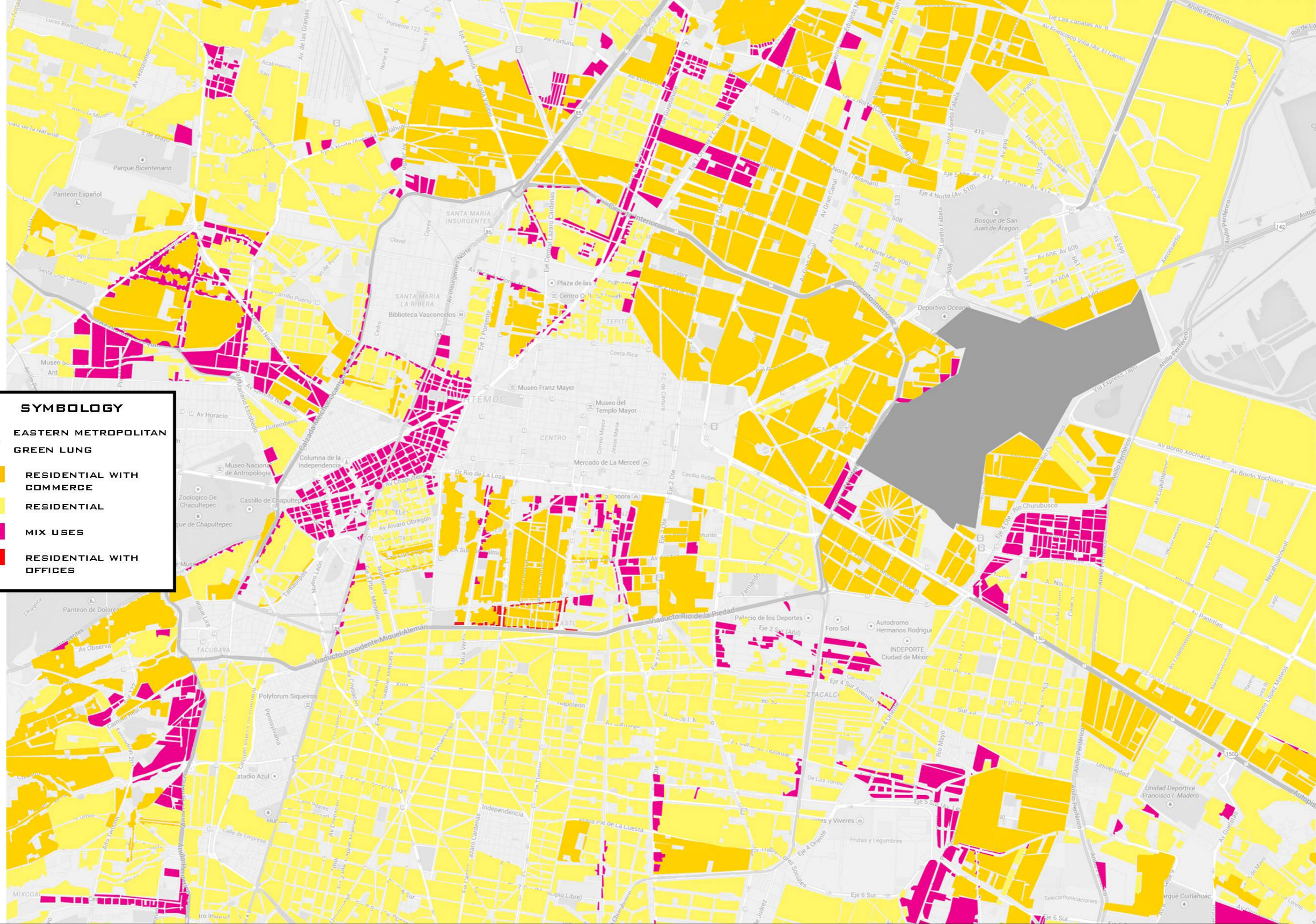

**SYMBOLOLOGY**

- EASTERN METROPOLITAN GREEN LUNG
- RESIDENTIAL WITH COMMERCE
- RESIDENTIAL
- MIX USES
- RESIDENTIAL WITH OFFICES



**POLITECNICO DI MILANO**  
**FACOLTÀ DI INGEGNERIA EDILE - ARCHITETTURA**  
**MASTER IN ARCHITECTURAL ENGINEERING**  
**2013 - 2015**

**EASTERN METROPOLITAN GREEN LUNG**



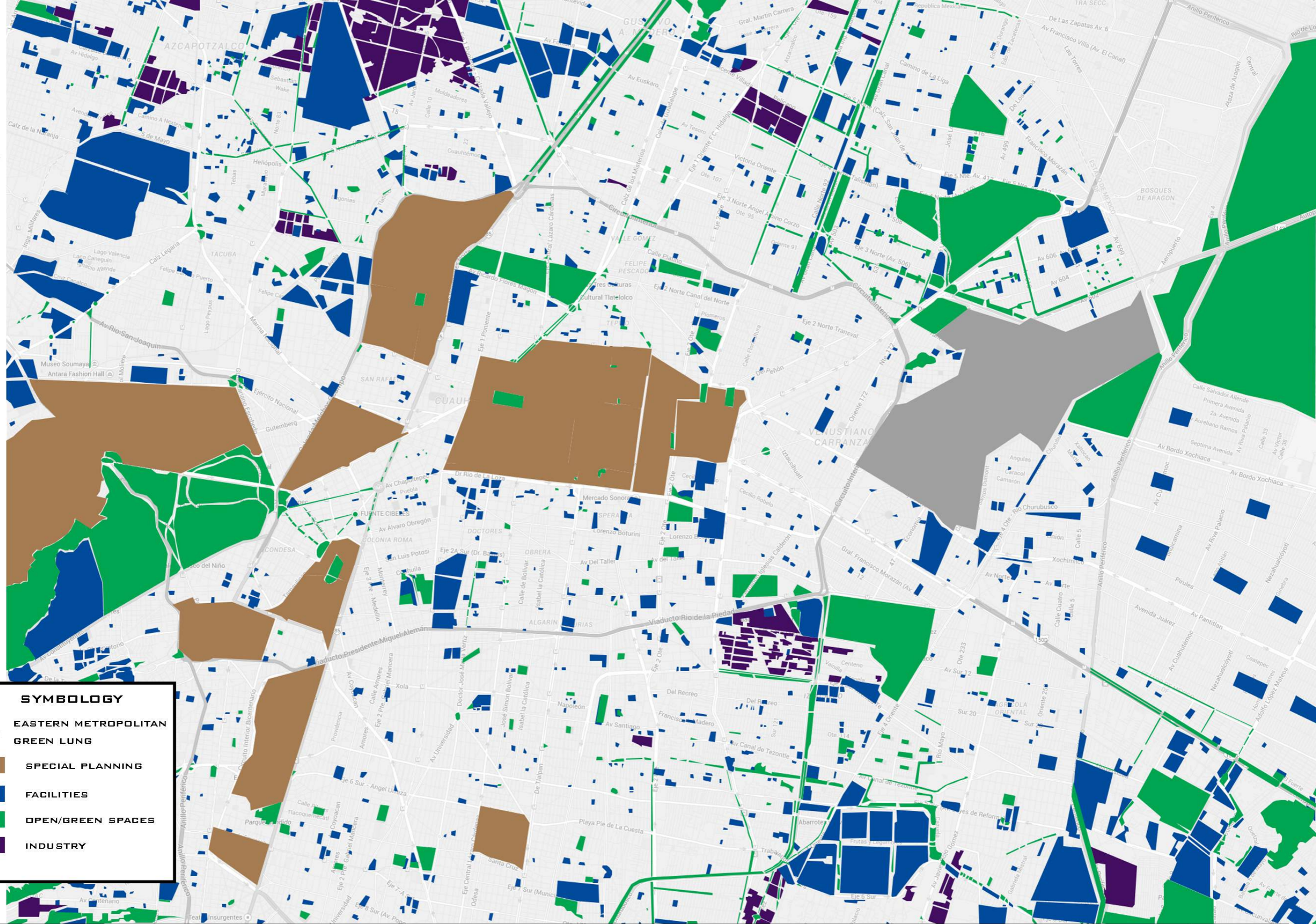
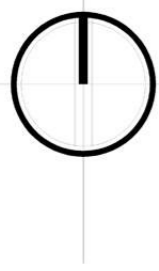

Consuelo Concepción Velazco Sánchez 814744  
 Fabio Andrés Ríos Franco 819782

Content:  
**Residential Uses**  
 Scale:  
**S/E**

**U-04**



**SYMBOLGY**

-  EASTERN METROPOLITAN GREEN LUNG
-  SPECIAL PLANNING
-  FACILITIES
-  OPEN/GREEN SPACES
-  INDUSTRY



**POLITECNICO DI MILANO**  
**FACOLTÀ DI INGEGNERIA EDILE - ARCHITETTURA**  
**MASTER IN ARCHITECTURAL ENGINEERING**  
**2013 - 2015**

**EASTERN METROPOLITAN GREEN LUNG**

Consuelo Concepción Velazco Sánchez 814744  
 Fabio Andrés Ríos Franco 819782

Content:  
**Open/Green Public Spaces, Special Plan**  
 Scale:  
**S/E**

**U-05**

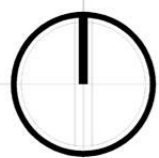

**SYMBOLY**

-  EASTERN METROPOLITAN GREEN LUNG
-  DELEGATION BOUNDARY
-  ROAD CORRIDORS
-  CIRCUITS
-  CETRAM
-  BUS STATION
-  GOVERNMENT EQUIPMENT
-  CULTURAL EQUIPMENT
-  OPEN SPACES
-  SPORT FACILITIES
-  MARKET
-  EDUCATION
-  HEALT

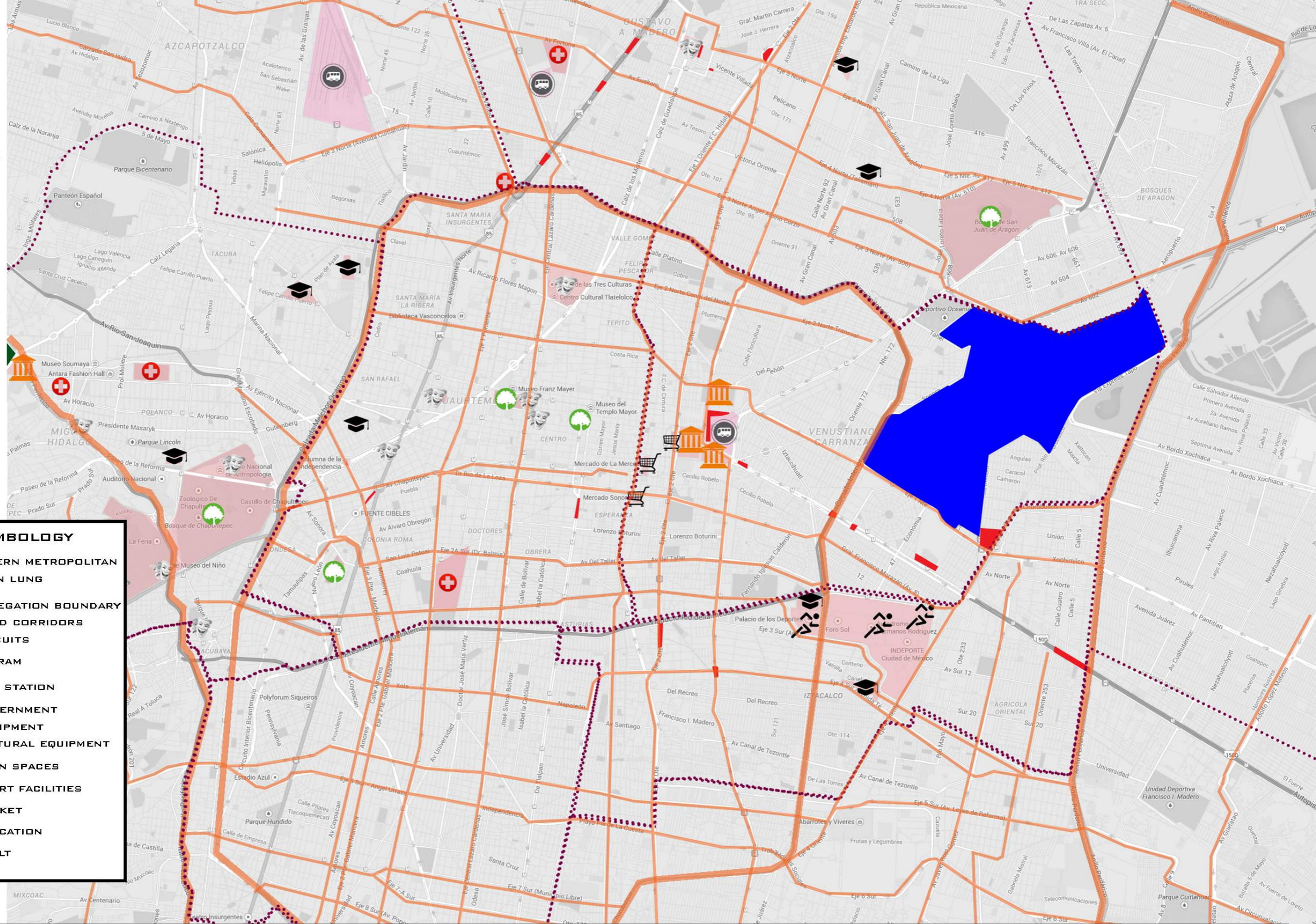

**POLITECNICO DI MILANO**  
**FACOLTÀ DI INGEGNERIA EDILE - ARCHITETTURA**  
**MASTER IN ARCHITECTURAL ENGINEERING**  
**2013 - 2015**

## EASTERN METROPOLITAN GREEN LUNG

Consuelo Concepción Velazco Sánchez 814744  
 Fabio Andrés Ríos Franco 819782

Content:  
**Urban Facilities of Metropolitan Influence**  
 Scale:  
**S/E**

**U-06**



**SYMBOLY**

**EASTERN METROPOLITAN GREEN LUNG**

- EASTERN METROPOLITAN GREEN LUNG
- LINE 1
- LINE 2
- LINE 3
- LINE 4
- LINE 5
- LINE 6
- LINE 7
- LINE 8
- LINE 9
- LINE A
- LINE B

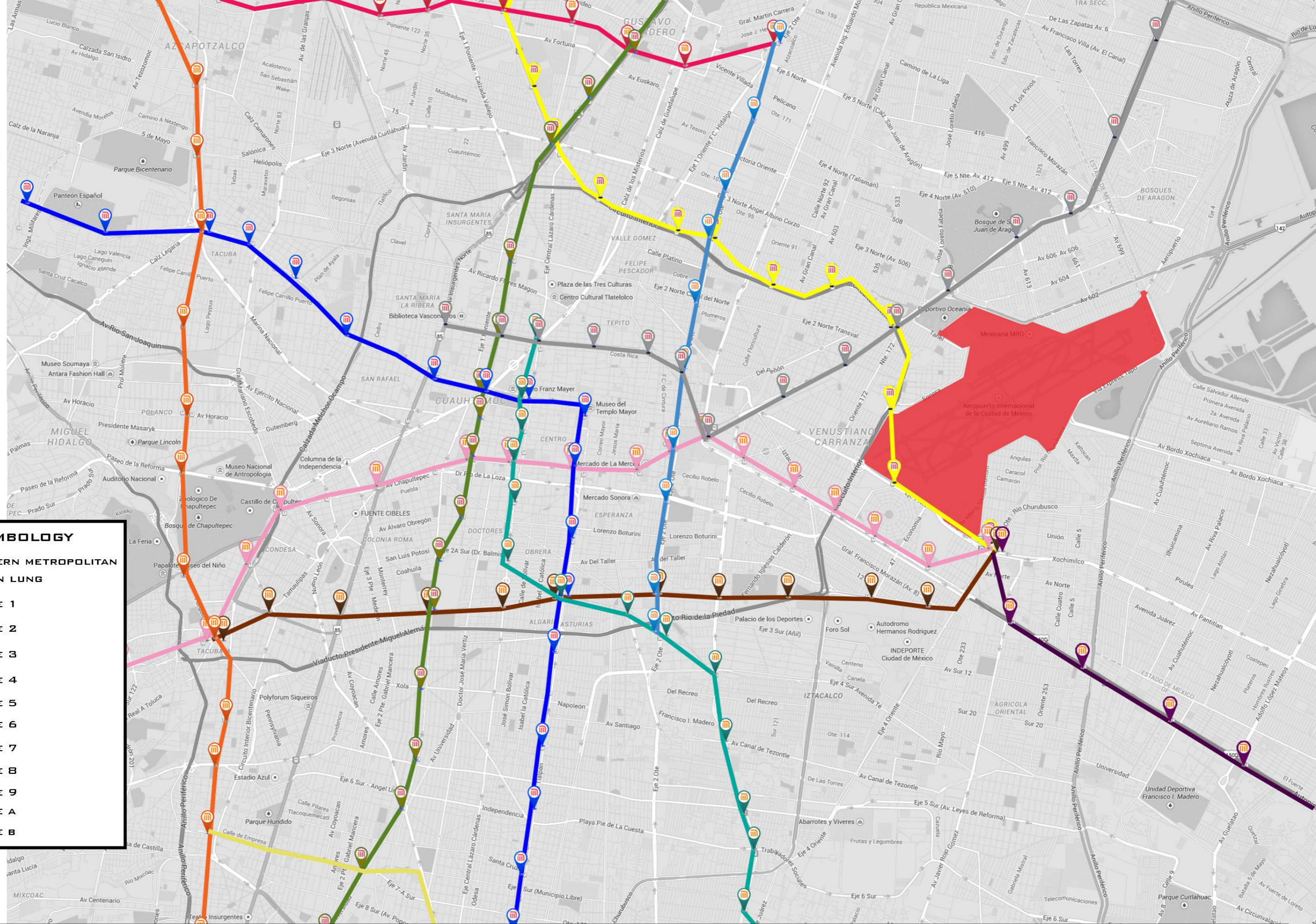

**POLITECNICO DI MILANO**  
**FACOLTÀ DI INGEGNERIA EDILE - ARCHITETTURA**  
**MASTER IN ARCHITECTURAL ENGINEERING**  
**2013 - 2015**

**EASTERN METROPOLITAN GREEN LUNG**

Consuelo Concepción Velazco Sánchez 814744  
 Fabio Andrés Ríos Franco 819782









Content:  
**Metro Lines**  
 Scale:  
**S/E**

**U-07**





**SYMBOLY**

-  **EASTERN METROPOLITAN GREEN LUNG**
-  **LINE 1**
-  **LINE 2**
-  **LINE 3**
-  **LINE 4**
-  **LINE 5**
-  **EXISTING CYCLING PATHS**
-  **ECOBIVI STATION**

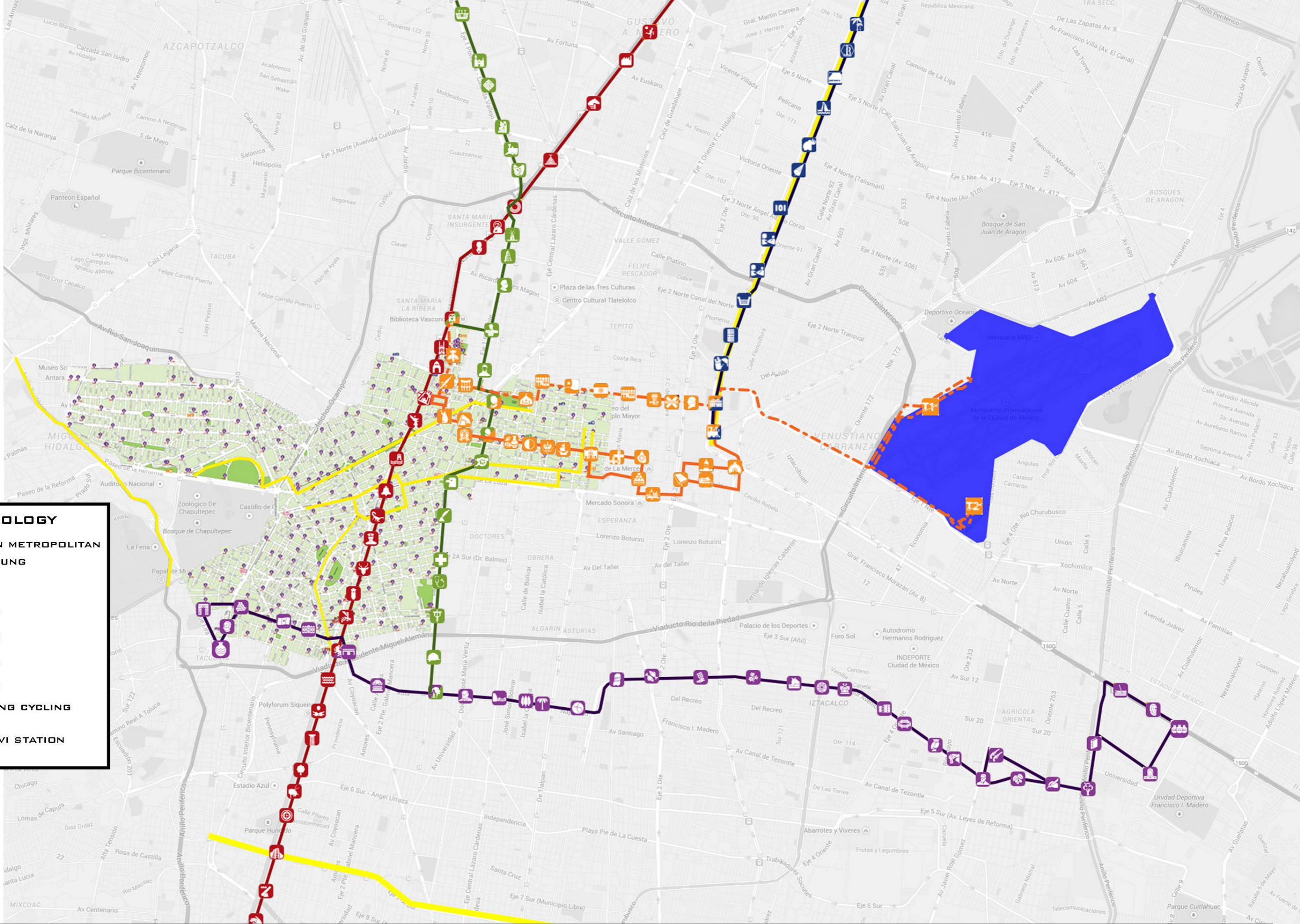

**POLITECNICO DI MILANO**  
**FACOLTÀ DI INGEGNERIA EDILE - ARCHITETTURA**  
**MASTER IN ARCHITECTURAL ENGINEERING**  
**2013 - 2015**

## EASTERN METROPOLITAN GREEN LUNG

Consuelo Concepción Velazco Sánchez 814744  
 Fabio Andrés Ríos Franco 819782

Content:  
**BRT System and Bicycle Mobility**  
 Scale:  
**S/E**

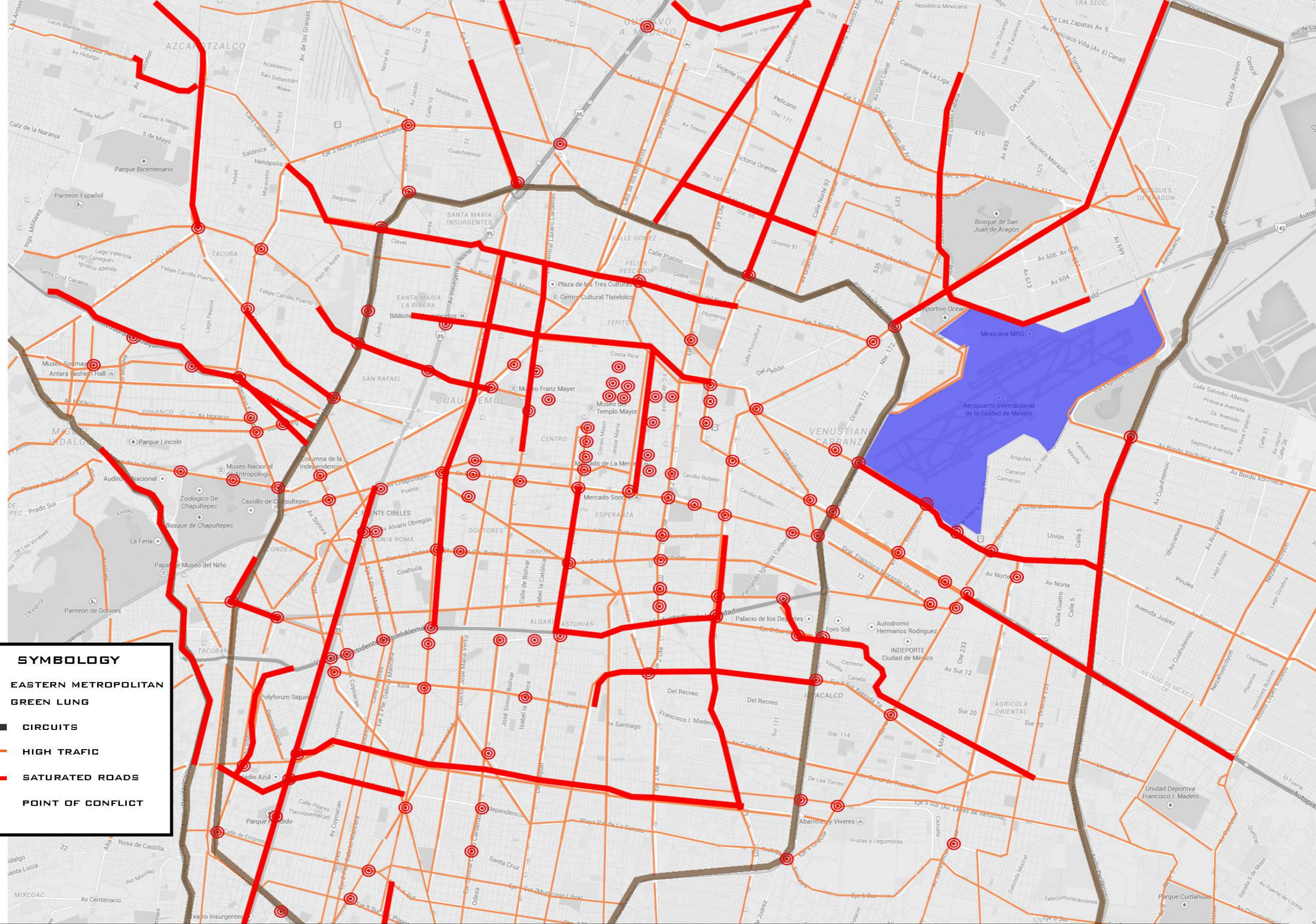
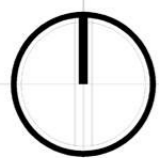

**SYMBOLOLOGY**

- EASTERN METROPOLITAN GREEN LUNG
- CIRCUITS
- HIGH TRAFFIC
- SATURATED ROADS
- POINT OF CONFLICT



**POLITECNICO DI MILANO**  
**FACOLTÀ DI INGEGNERIA EDILE - ARCHITETTURA**  
**MASTER IN ARCHITECTURAL ENGINEERING**  
**2013 - 2015**

### EASTERN METROPOLITAN GREEN LUNG







Consuelo Concepción Velazco Sánchez 814744  
 Fabio Andrés Ríos Franco 819782

Content:  
**Street Network and Traffic Conflicts**  
 Scale:  
**S/E**

**U-09**



**SYMBOLY**

-  **EASTERN METROPOLITAN GREEN LUNG**
-  **DELEGATION BOUNDARY**
-  **0 - 054**
-  **055 - 1,722**
-  **1,723 - 3,004**
-  **3,005 - 5,328**
-  **5,329 - 8,934**

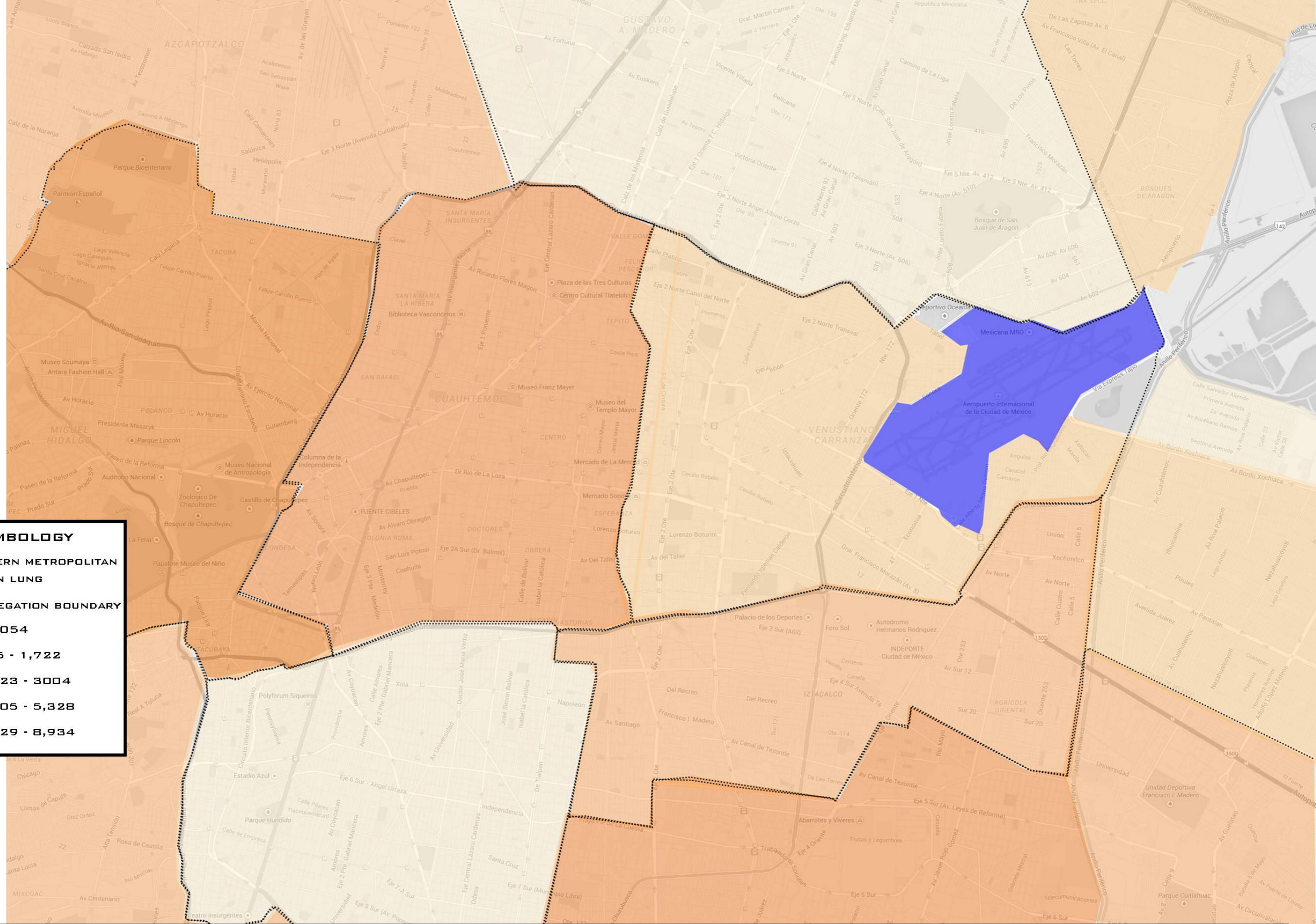

**POLITECNICO DI MILANO**  
**FACOLTÀ DI INGEGNERIA EDILE - ARCHITETTURA**  
**MASTER IN ARCHITECTURAL ENGINEERING**  
**2013 - 2015**





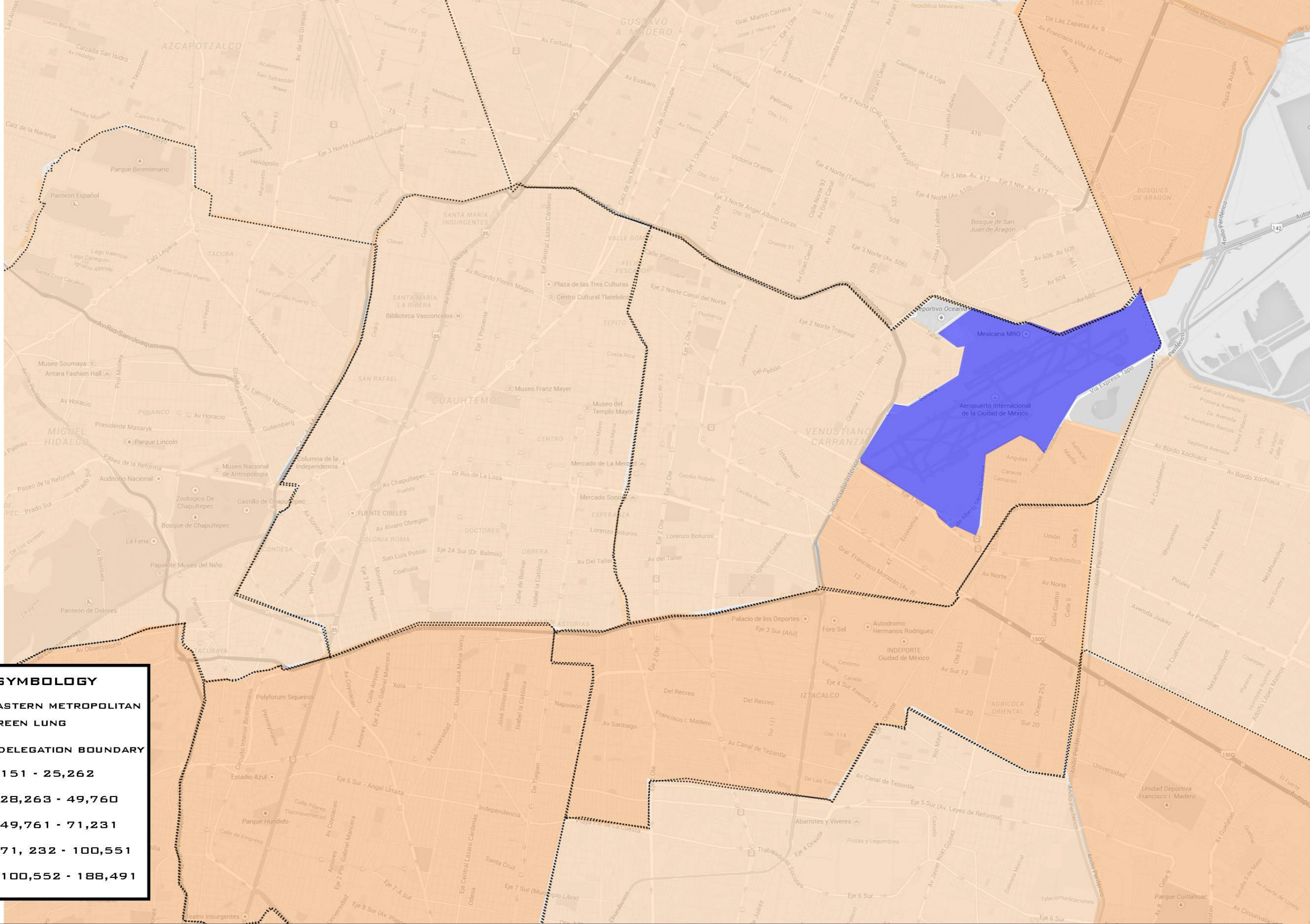
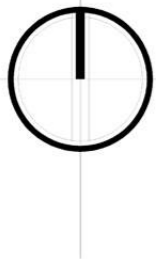

**EASTERN METROPOLITAN GREEN LUNG**

Consuelo Concepción Velazco Sánchez 814744  
 Fabio Andrés Ríos Franco 819782

Content:  
**Way to Work Trips**  
 Scale:  
**S/E**



**SYMBOLY**

-  EASTERN METROPOLITAN GREEN LUNG
-  DELEGATION BOUNDARY
-  151 - 25,262
-  28,263 - 49,760
-  49,761 - 71,231
-  71, 232 - 100,551
-  100,552 - 188,491



**POLITECNICO DI MILANO**  
**FACOLTÀ DI INGEGNERIA EDILE - ARCHITETTURA**  
**MASTER IN ARCHITECTURAL ENGINEERING**  
**2013 - 2015**

**EASTERN METROPOLITAN GREEN LUNG**

Consuelo Concepción Velazco Sánchez 814744  
 Fabio Andrés Ríos Franco 819782

Content:  
**Way Back Home Trips**  
 Scale:  
**S/E**

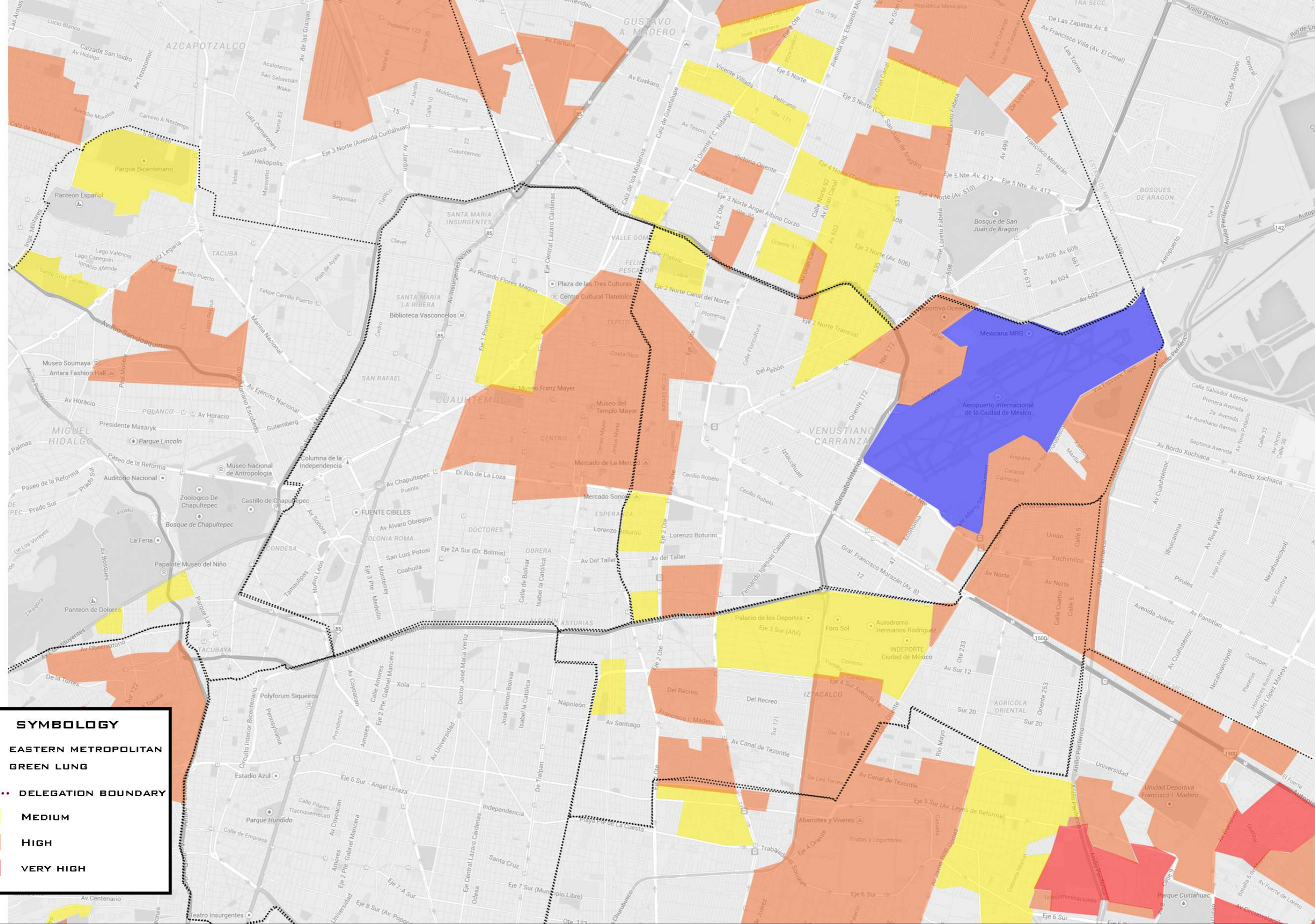
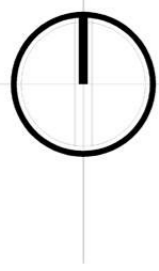

**SYMBOLY**

- EASTERN METROPOLITAN GREEN LUNG
- DELEGATION BOUNDARY
- MEDIUM
- HIGH
- VERY HIGH



**POLITECNICO DI MILANO**  
**FACOLTÀ DI INGEGNERIA EDILE - ARCHITETTURA**  
**MASTER IN ARCHITECTURAL ENGINEERING**  
**2013 - 2015**

**EASTERN METROPOLITAN GREEN LUNG**

Consuelo Concepción Velazco Sánchez 814744  
 Fabio Andrés Ríos Franco 819782

Content:  
**Poverty Index**  
 Scale:  
**S/E**

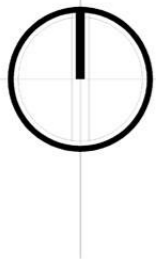

**SYMBOLY**

- EASTERN METROPOLITAN GREEN LUNG
- DELEGATION BOUNDARY
- LOW
- MEDIUM
- HIGH

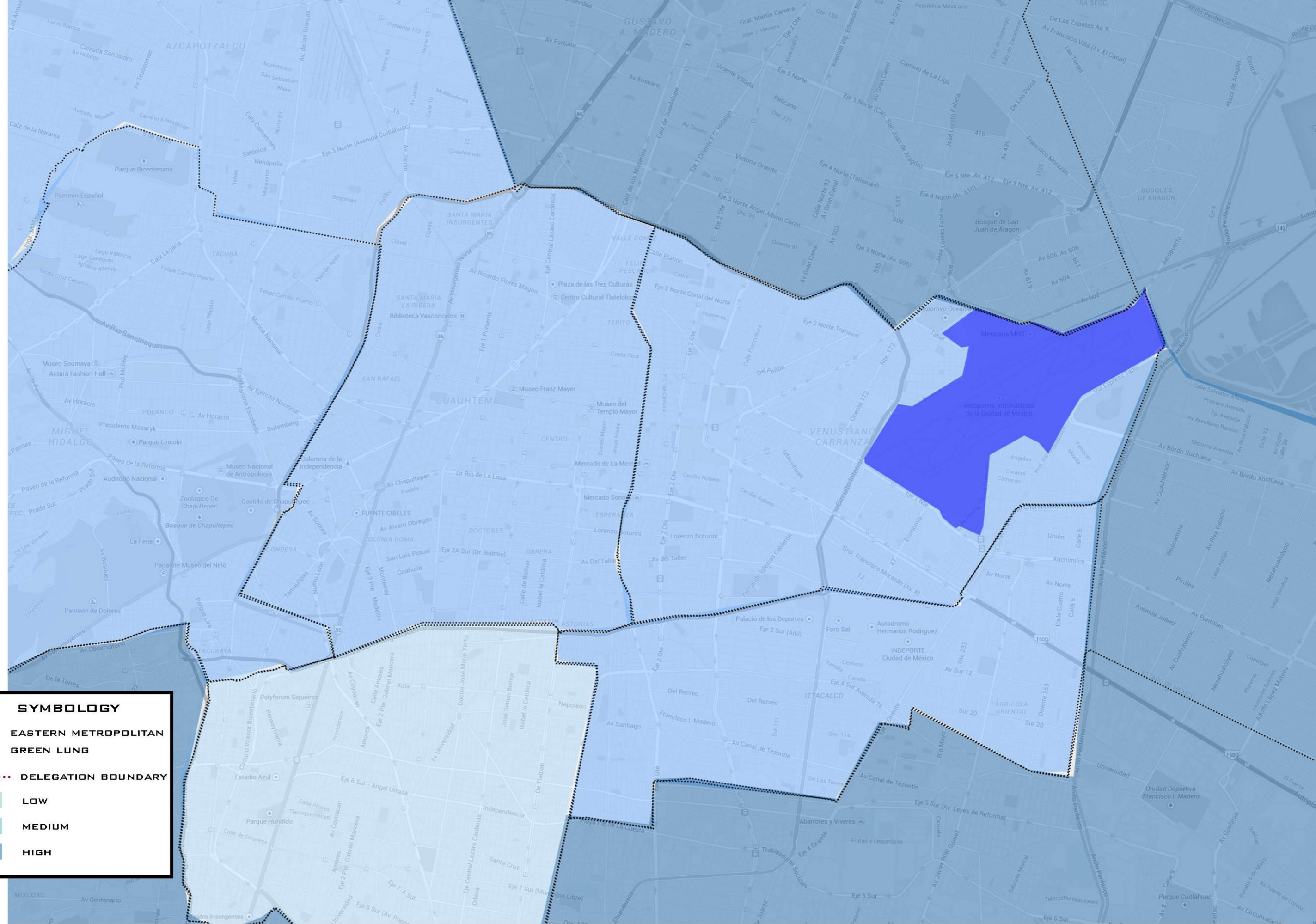

**POLITECNICO DI MILANO**  
**FACOLTÀ DI INGEGNERIA EDILE - ARCHITETTURA**  
**MASTER IN ARCHITECTURAL ENGINEERING**  
**2013 - 2015**

## EASTERN METROPOLITAN GREEN LUNG

Consuelo Concepción Velazco Sánchez 814744  
Fabio Andrés Ríos Franco 819782

Content:  
**Flood Hazard**  
Scale:  
**S/E**

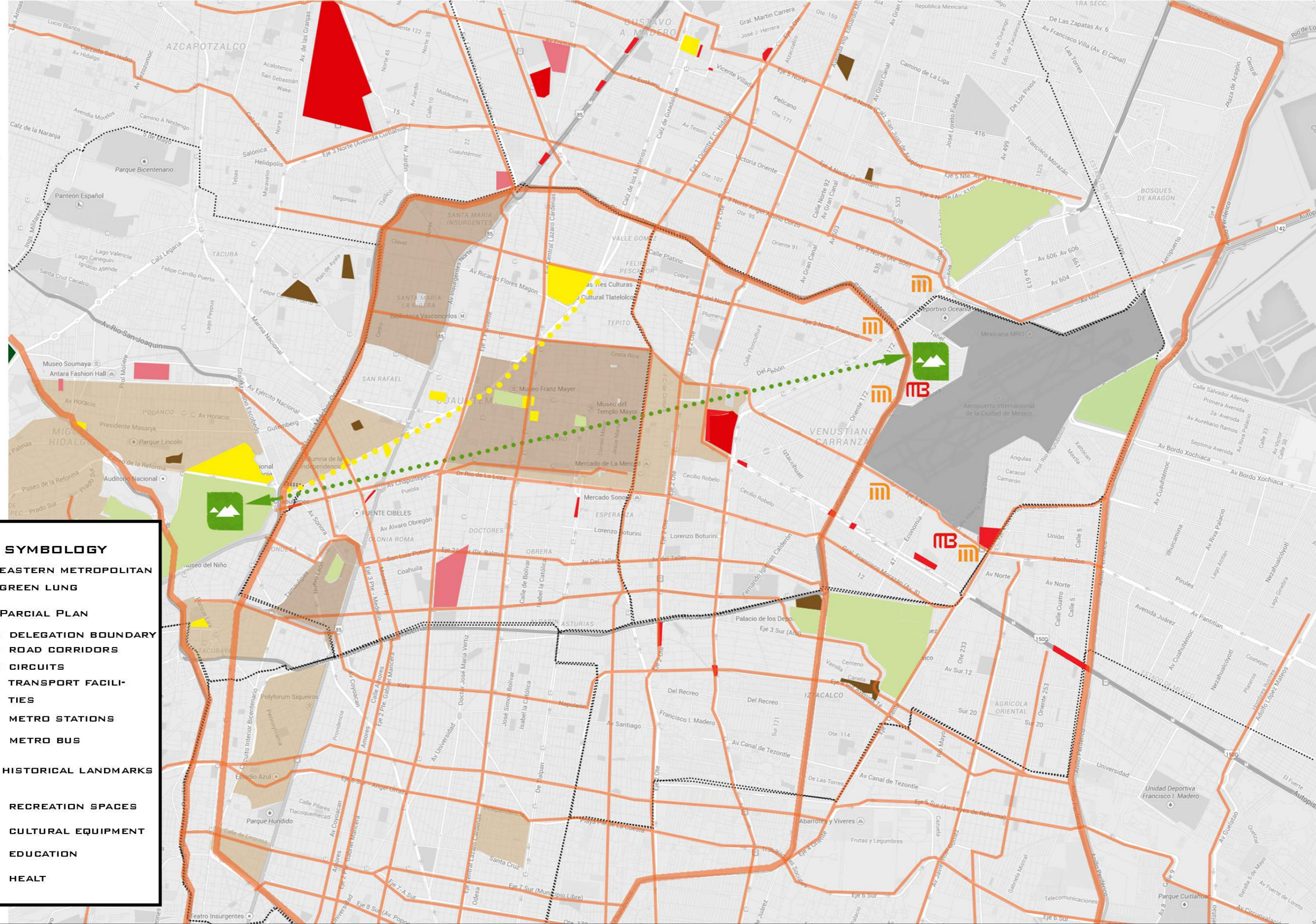
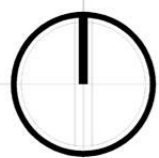

**SYMBOLOLOGY**

- EASTERN METROPOLITAN GREEN LUNG
- PARCIAL PLAN
- DELEGATION BOUNDARY
- ROAD CORRIDORS
- CIRCUITS
- TRANSPORT FACILITIES
- METRO STATIONS
- METRO BUS
- HISTORICAL LANDMARKS
- RECREATION SPACES
- CULTURAL EQUIPMENT
- EDUCATION
- HEALT



**POLITECNICO DI MILANO**  
**FACOLTÀ DI INGEGNERIA EDILE - ARCHITETTURA**  
**MASTER IN ARCHITECTURAL ENGINEERING**  
**2013 - 2015**

**EASTERN METROPOLITAN GREEN LUNG**

Consuelo Concepción Velazco Sánchez 814744  
 Fabio Andrés Ríos Franco 819782

Content:  
**Analysis: Positive Aspects**  
 Scale:  
**S/E**



**SYMBOLY**

-  EASTERN METROPOLITAN GREEN LUNG
-  ADMIN. BUILDINGS
-  DELEGATION BOUNDARY
-  FEDERAL LIMIT
-  URBAN FABRIC LIMIT
-  PHYSICAL BARRIERS
-  CONNECTION BY INFORMAL PUBLIC TRANSPORT
-  CRITICAL TRAFFIC ZONES
-  CONGESTED AVENUES
-  ZONES WITH A CERTAIN LEVEL OF POVERTY
-  HIGH FLOODINGS RISK

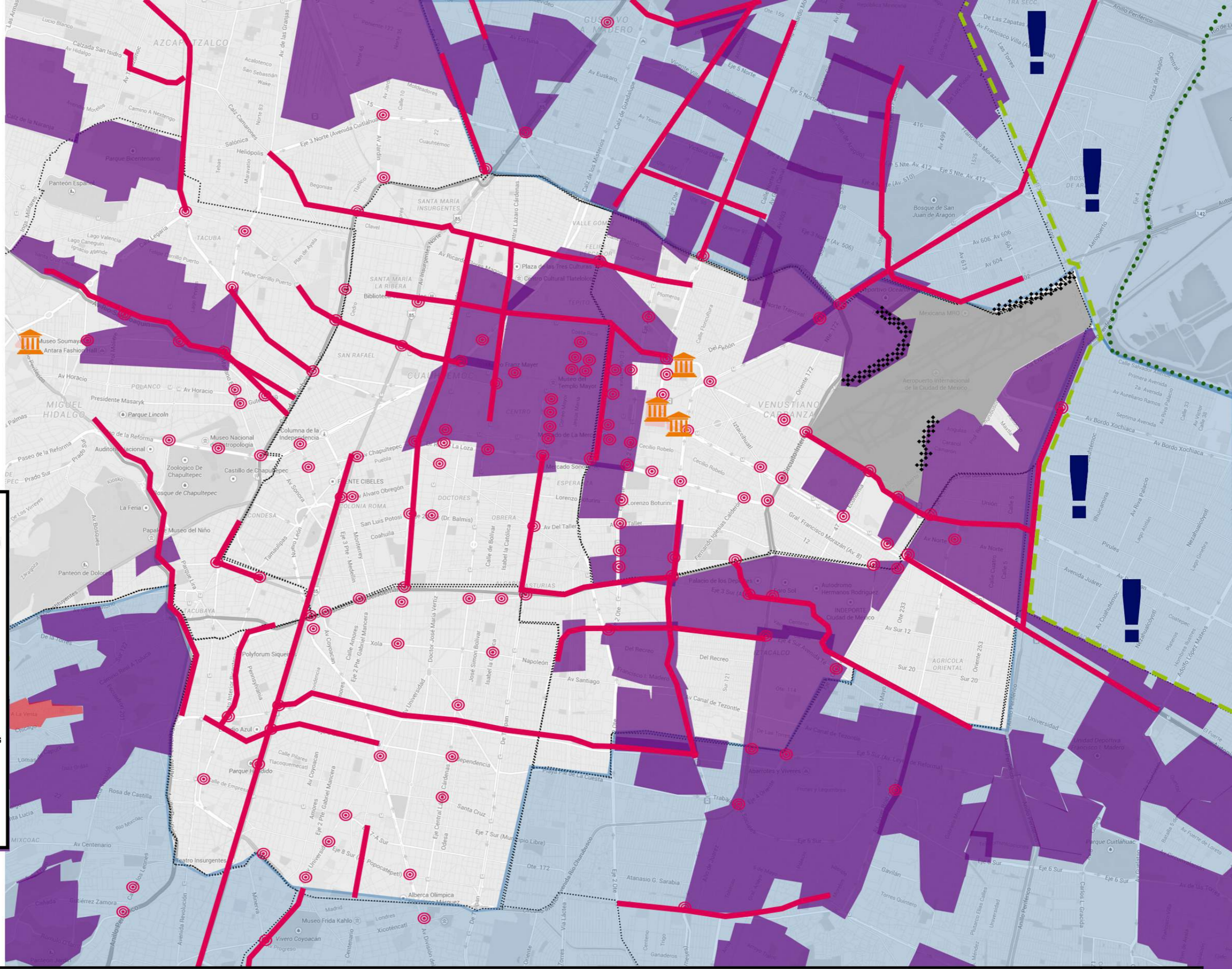

**POLITECNICO DI MILANO**  
**FACOLTÀ DI INGEGNERIA EDILE - ARCHITETTURA**  
**MASTER IN ARCHITECTURAL ENGINEERING**  
 2013 - 2015

**EASTERN METROPOLITAN GREEN LUNG**

Consuelo Concepción Velazco Sánchez 814744  
 Fabio Andrés Ríos Franco 819782

Content:  
**Analysis: Negative Aspects**  
 Scale:  
**S/E**





### Legend

#### VISION

- ▶ Entrances
- A Comercial center/hotel
- B Comercial center/hotel
- C Sweet lake
- D Salty lake
- E Water treatment plant
- F Nursery garden
- G Composting
- H University
- I Exhibition center
- J Hotel
- K Outdoor exhibition
- L Cultural market

#### LANDMARKS

- 1 Alameda Oriente
- 2 Lago de Texcoco, protected area
- 3 Peñon de los Baños
- 4 Deportivo Oceania
- 5 Bosque de Aragon



## EASTERN METROPOLITAN GREEN LUNG

Consuelo Concepción Velazco Sánchez 814744  
 Fabio Andrés Ríos Franco 819782

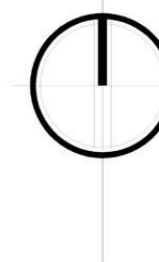
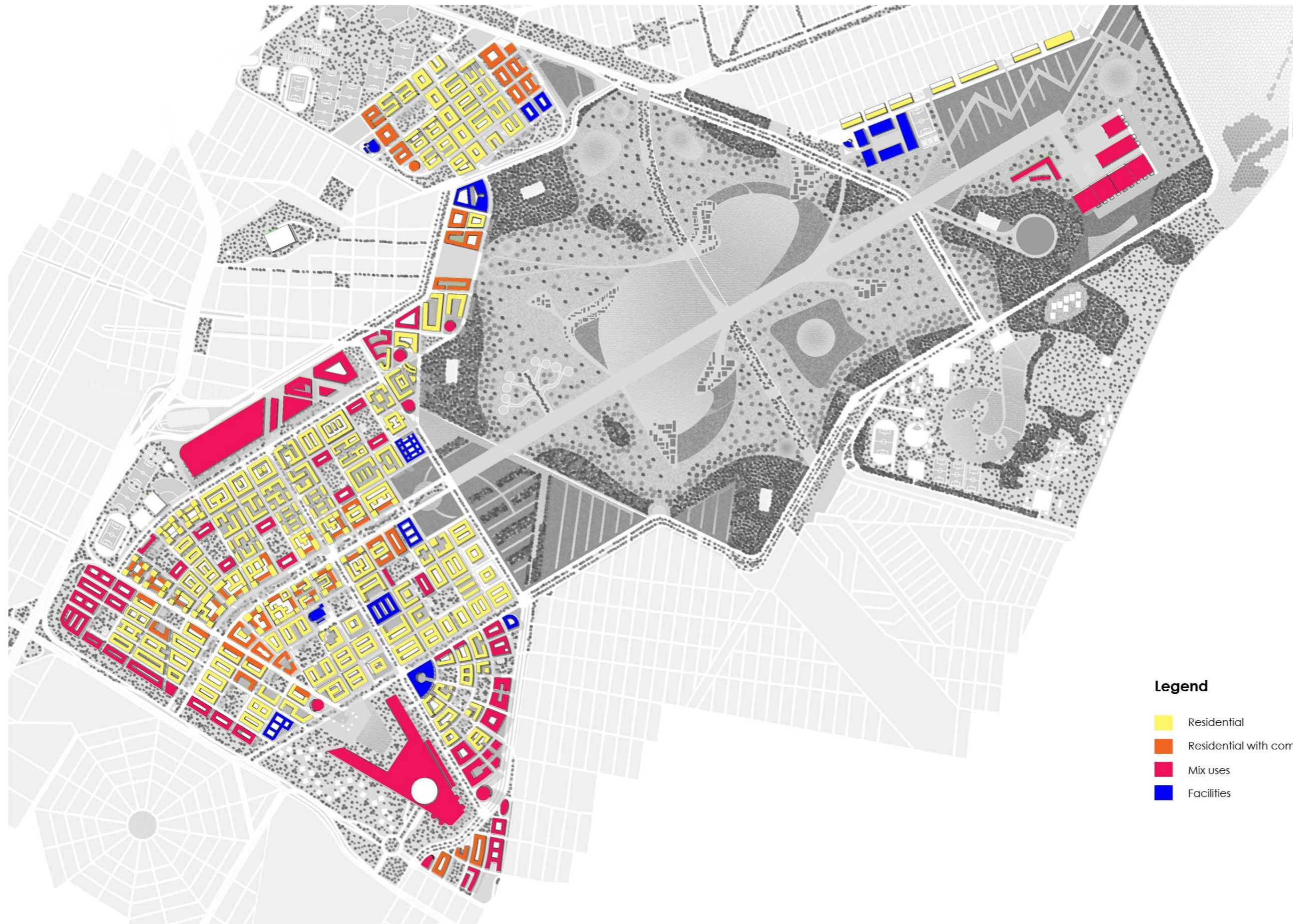

**Legend**

- Residential
- Residential with commerce
- Mix uses
- Facilities



**POLITECNICO DI MILANO**  
**FACOLTÀ DI INGEGNERIA EDILE - ARCHITETTURA**  
**MASTER IN ARCHITECTURAL ENGINEERING**  
**2013 - 2015**







**EASTERN METROPOLITAN GREEN LUNG**

Consuelo Concepción Velazco Sánchez 814744  
 Fabio Andrés Ríos Franco 819782

Content:  
**Land Use Proposal**  
 Scale:  
**S/E**



**Legend**

-  Ecobici station
-  Cycling path
-  Metrobus station
-  Metrobus lanes
-  Metro station
-  Metro lines



**POLITECNICO DI MILANO**  
**FACOLTÀ DI INGEGNERIA EDILE - ARCHITETTURA**  
**MASTER IN ARCHITECTURAL ENGINEERING**  
**2013 - 2015**

**EASTERN METROPOLITAN GREEN LUNG**

Consuelo Concepción Velazco Sánchez 814744  
 Fabio Andrés Ríos Franco 819782

Content:  
**Sustainable Mobility**  
 Scale:  
**S/E**

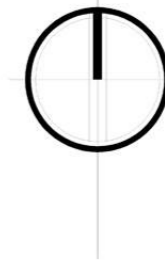

- Legend**
- Solar panels
  - Agricultural area
  - Wetlands
  - Water
  - Public/comon spaces
  - Urban green areas
  - Dense woodlands
  - Metropolitan park



POLITECNICO DI MILANO  
FACOLTÀ DI INGEGNERIA EDILE - ARCHITETTURA  
MASTER IN ARCHITECTURAL ENGINEERING  
2013 - 2015

### EASTERN METROPOLITAN GREEN LUNG

Consuelo Concepción Velazco Sánchez 814744  
Fabio Andrés Ríos Franco 819782

Content:  
**Green Network**  
Scale:  
S/E

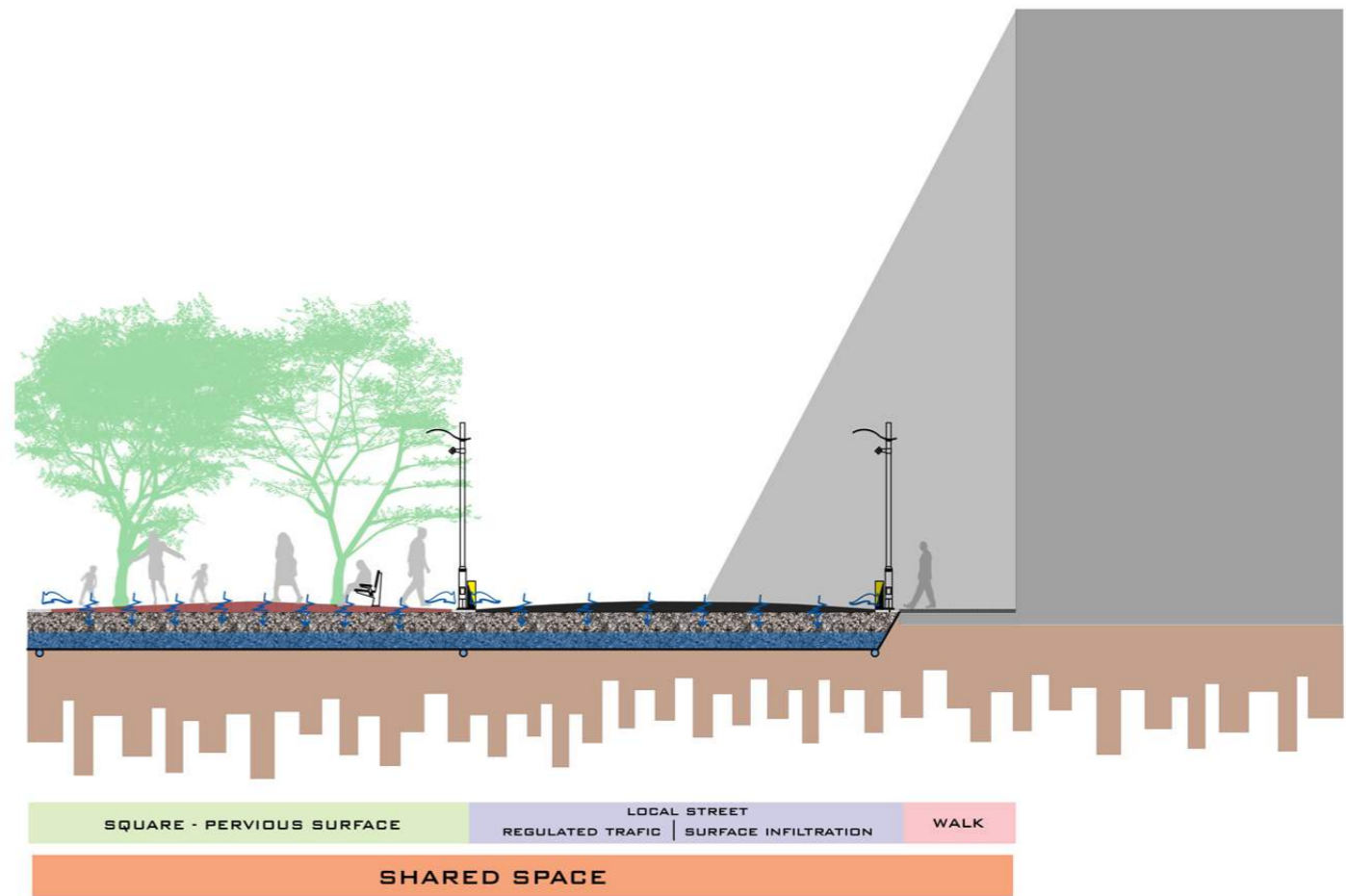

POLITECNICO DI MILANO  
FACOLTÀ DI INGEGNERIA EDILE - ARCHITETTURA  
MASTER IN ARCHITECTURAL ENGINEERING  
2013 - 2015

## EASTERN METROPOLITAN GREEN LUNG

Consuelo Concepción Velazco Sánchez 814744  
Fabio Andrés Ríos Franco 819782

Content:  
**SuDS Strategies Detail 1 and 2**  
Scale:  
S/E

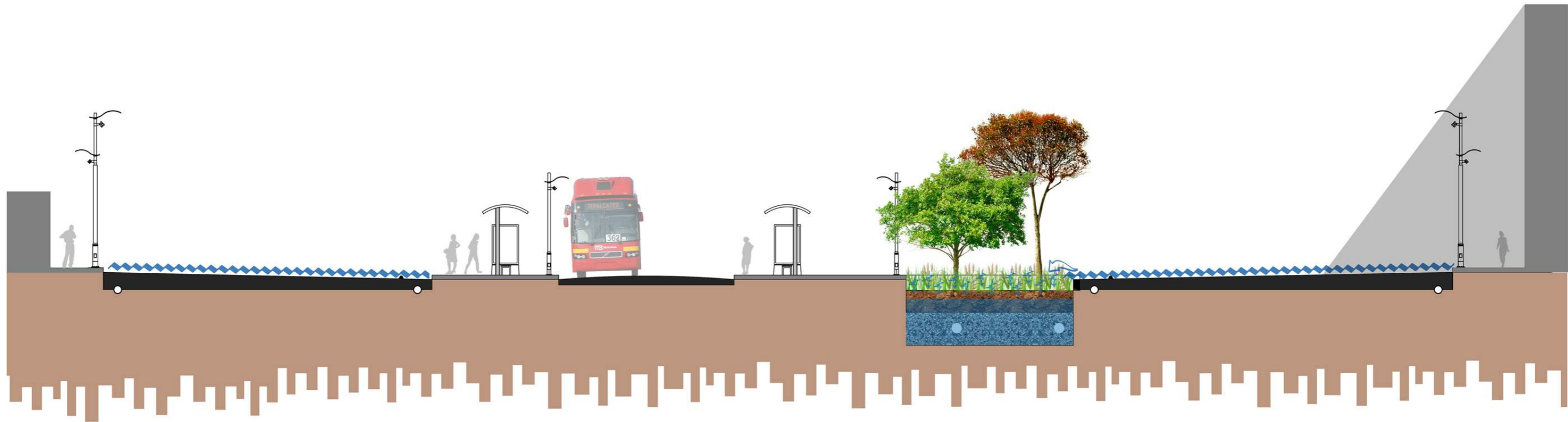

WALK    CYCLE 1 WAY - DRIVE 1 WAY    MEDIAN STRIP BUS STOP    METROBUS 2 WAYS    MEDIAN STRIP BUS STOP    PLANTER | URBAN ACTIVATION    CYCLE 1 WAY - DRIVE 1 WAY    WALK

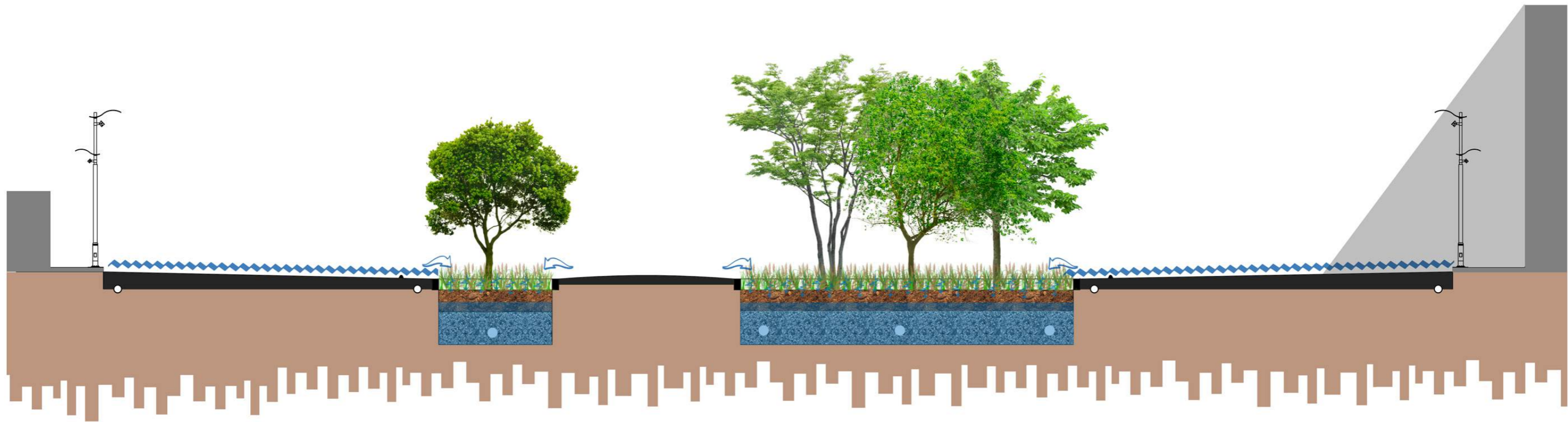

WALK    CYCLE 1 WAY - DRIVE 1 WAY    PLANTER | URBAN ACTIVATION    METROBUS 2 WAYS    PLANTER | URBAN ACTIVATION    CYCLE 1 WAY - DRIVE 1 WAY    WALK



POLITECNICO DI MILANO  
 FACOLTÀ DI INGEGNERIA EDILE - ARCHITETTURA  
 MASTER IN ARCHITECTURAL ENGINEERING  
 2013 - 2015

## EASTERN METROPOLITAN GREEN LUNG

Consuelo Concepción Velazco Sánchez 814744  
 Fabio Andrés Ríos Franco 819782

Content:  
**SuDS Strategies Detail 3**  
 Scale:  
 S/E

U-21

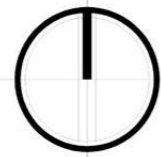

**SYMBOLOLOGY**

- RESIDENTIAL
- MIX USES
- FACILITIES
- GREEN/OPEN SPACES
- NEIGHBORHOOD BOUNDARY
- ARCHITECTURAL SITE
- CEMENTERY
- CAR RENT
- GARAGE
- PARK
- SPORTS CENTER
- SCHOOL
- CHURCH
- HOTEL
- RESTAURANT
- MINI SUPER

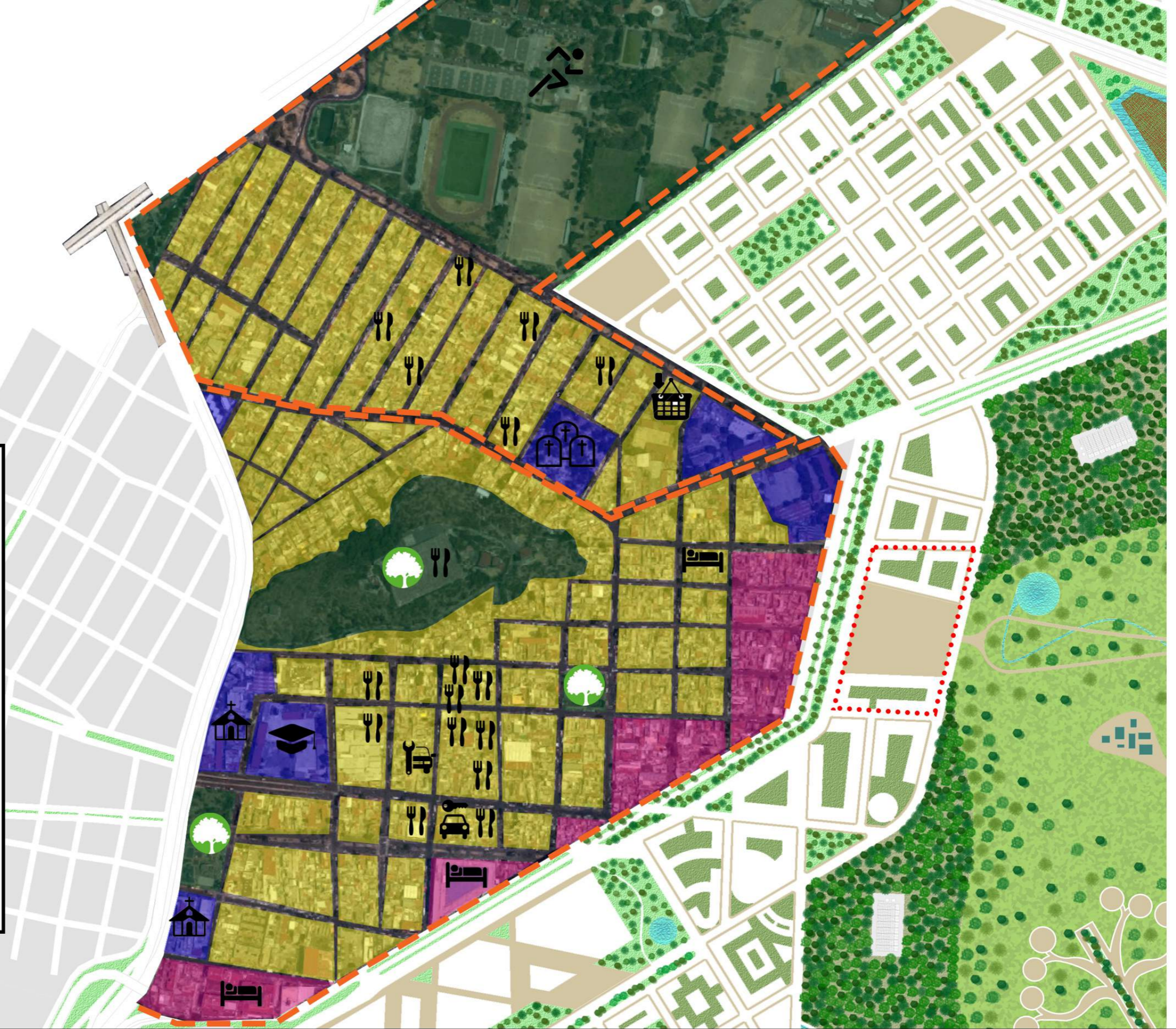



POLITECNICO DI MILANO  
FACOLTÀ DI INGEGNERIA EDILE - ARCHITETTURA  
MASTER IN ARCHITECTURAL ENGINEERING  
2013 - 2015

## EASTERN METROPOLITAN GREEN LUNG

Consuelo Concepción Velazco Sánchez 814744  
Fabio Andrés Ríos Franco 819782

Content:  
**Location plan**  
Scale:  
S/E

**A02**



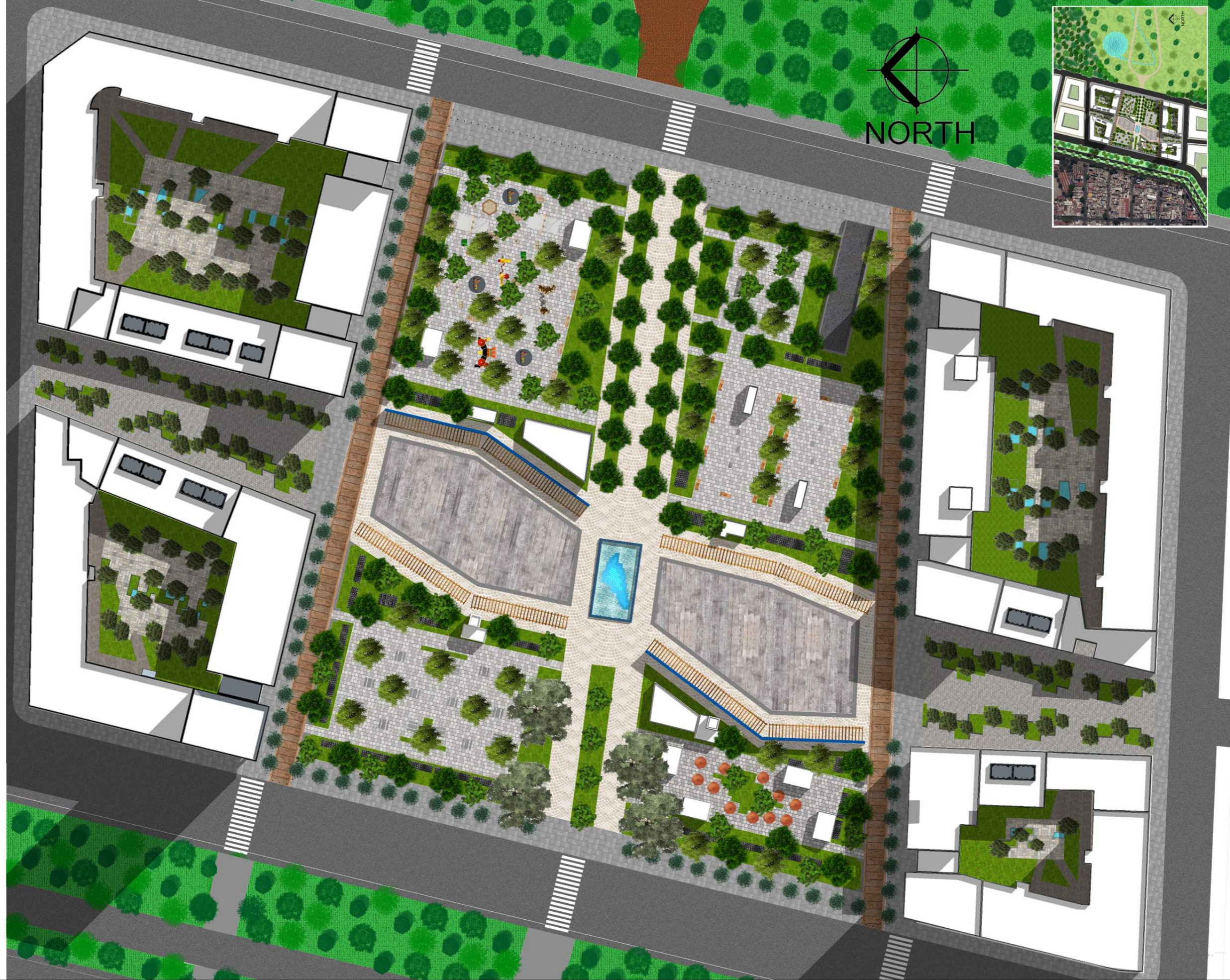

POLITECNICO DI MILANO  
 FACOLTÀ DI INGEGNERIA EDILE - ARCHITETTURA  
 MASTER IN ARCHITECTURAL ENGINEERING  
 2013 - 2015

## EASTERN METROPOLITAN GREEN LUNG







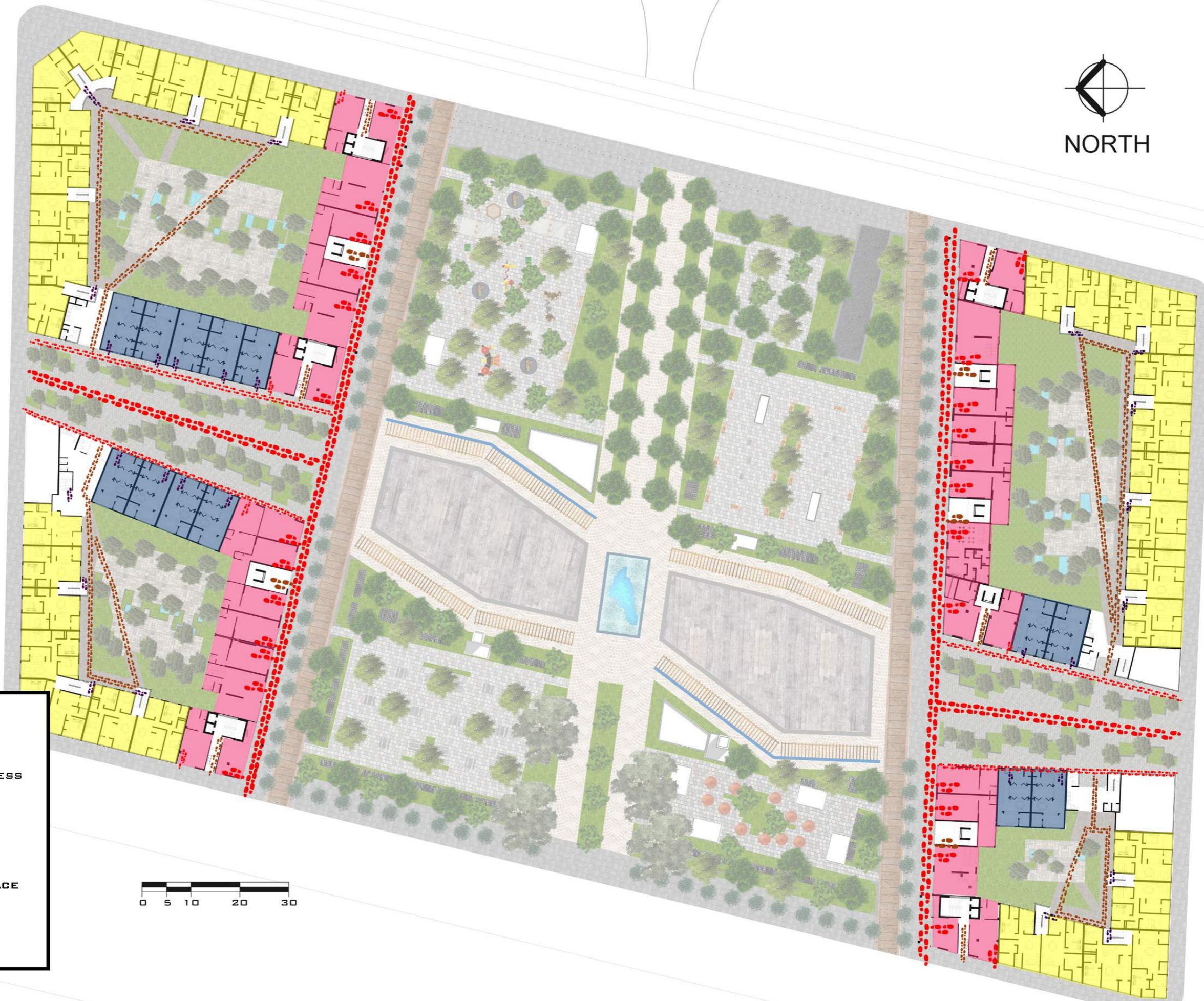

Consuelo Concepción Velazco Sánchez 814744  
 Fabio Andrés Ríos Franco 819782

Content:  
**Architectural Master Plan**  
 Scale:  
 S/E

**A03**



**SYMBOLOLOGY**

-  PUBLIC ACCESS
-  CONTROLLED ACCESS
-  PRIVATE ACCESS
-  HIGH FLOW
-  LOW FLOW
-  COMMERCIAL SPACE
-  APARTMENT
-  SINGLE HOUSE



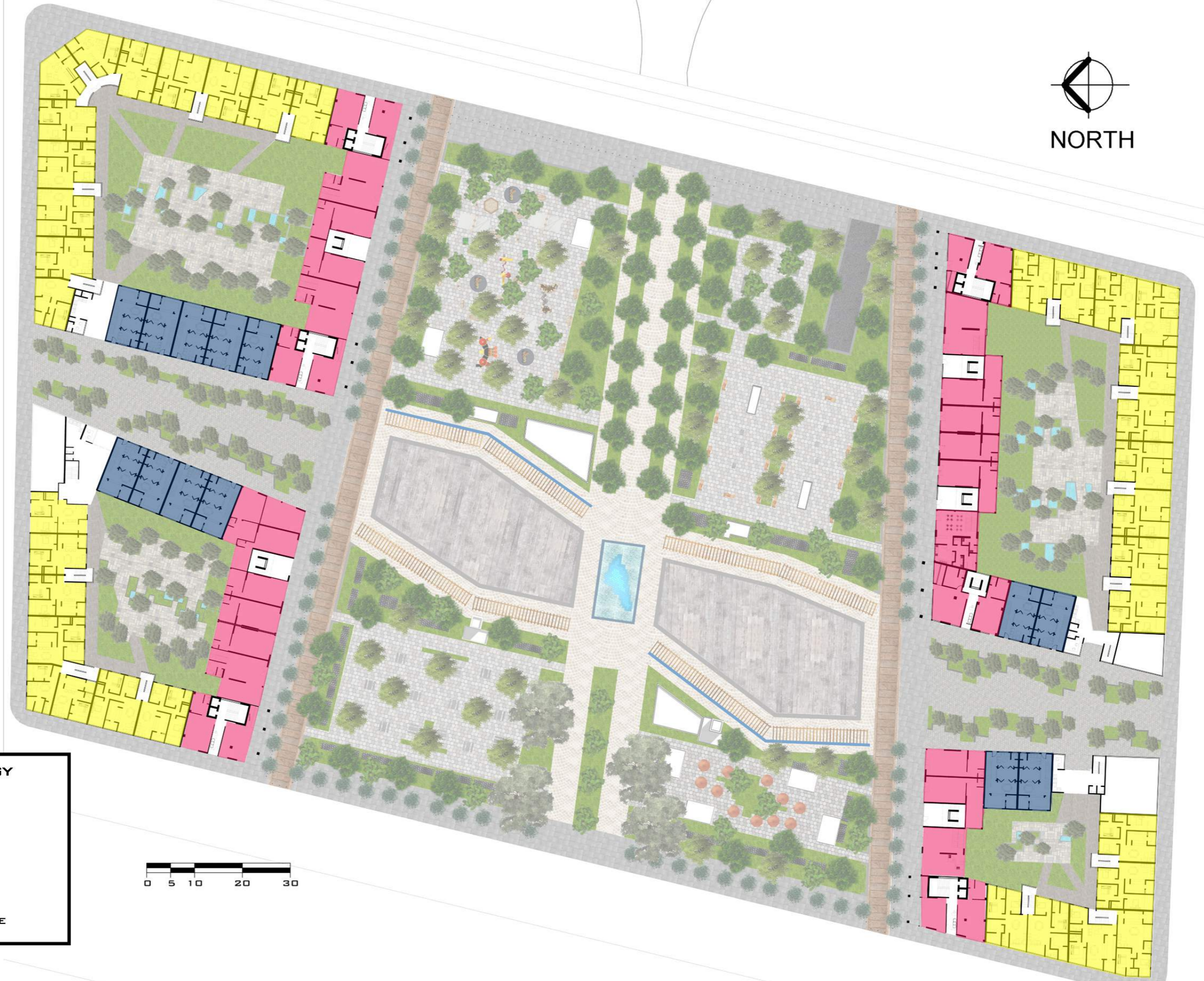

SYMBOLGY	
	COMMERCE
	OFFICE
	LOFT
	APPARTMENT
	SINGLE HOUSE



POLITECNICO DI MILANO  
FACOLTÀ DI INGEGNERIA EDILE - ARCHITETTURA  
MASTER IN ARCHITECTURAL ENGINEERING  
2013 - 2015

## EASTERN METROPOLITAN GREEN LUNG

Consuelo Concepción Velazco Sánchez 814744  
Fabio Andrés Ríos Franco 819782

Content:  
**Land Use. Ground Floor**  
Scale:  
**Graphic**

**A05**

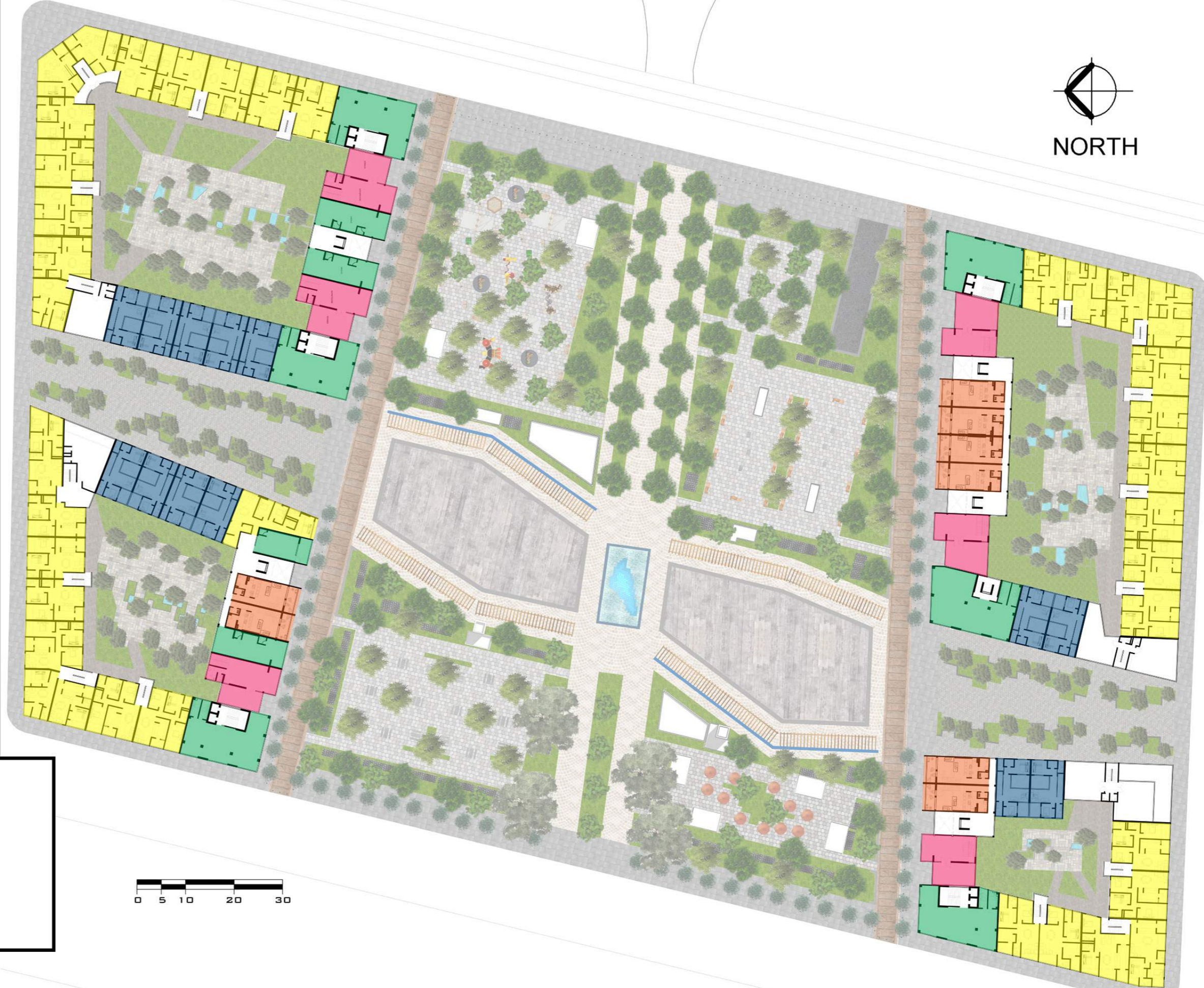

SYMBOLGY	
	COMMERCE
	OFFICE
	LOFT
	APPARTMENT
	SINGLE HOUSE



POLITECNICO DI MILANO  
FACOLTÀ DI INGEGNERIA EDILE - ARCHITETTURA  
MASTER IN ARCHITECTURAL ENGINEERING  
2013 - 2015

### EASTERN METROPOLITAN GREEN LUNG

Consuelo Concepción Velazco Sánchez 814744  
Fabio Andrés Ríos Franco 819782

Content:  
**Land Use. First Level**  
Scale:  
**Graphic**

**A06**



NORTH



**SYMBOLGY**

- COMMERCE
- OFFICE
- LOFT
- APPARTMENT
- SINGLE HOUSE



**POLITECNICO DI MILANO**  
**FACOLTÀ DI INGEGNERIA EDILE - ARCHITETTURA**  
**MASTER IN ARCHITECTURAL ENGINEERING**  
**2013 - 2015**

**EASTERN METROPOLITAN GREEN LUNG**

Consuelo Concepción Velazco Sánchez 814744  
 Fabio Andrés Ríos Franco 819782

Content:  
**Land Use. Second Level**  
 Scale:  
**Graphic**

**A07**

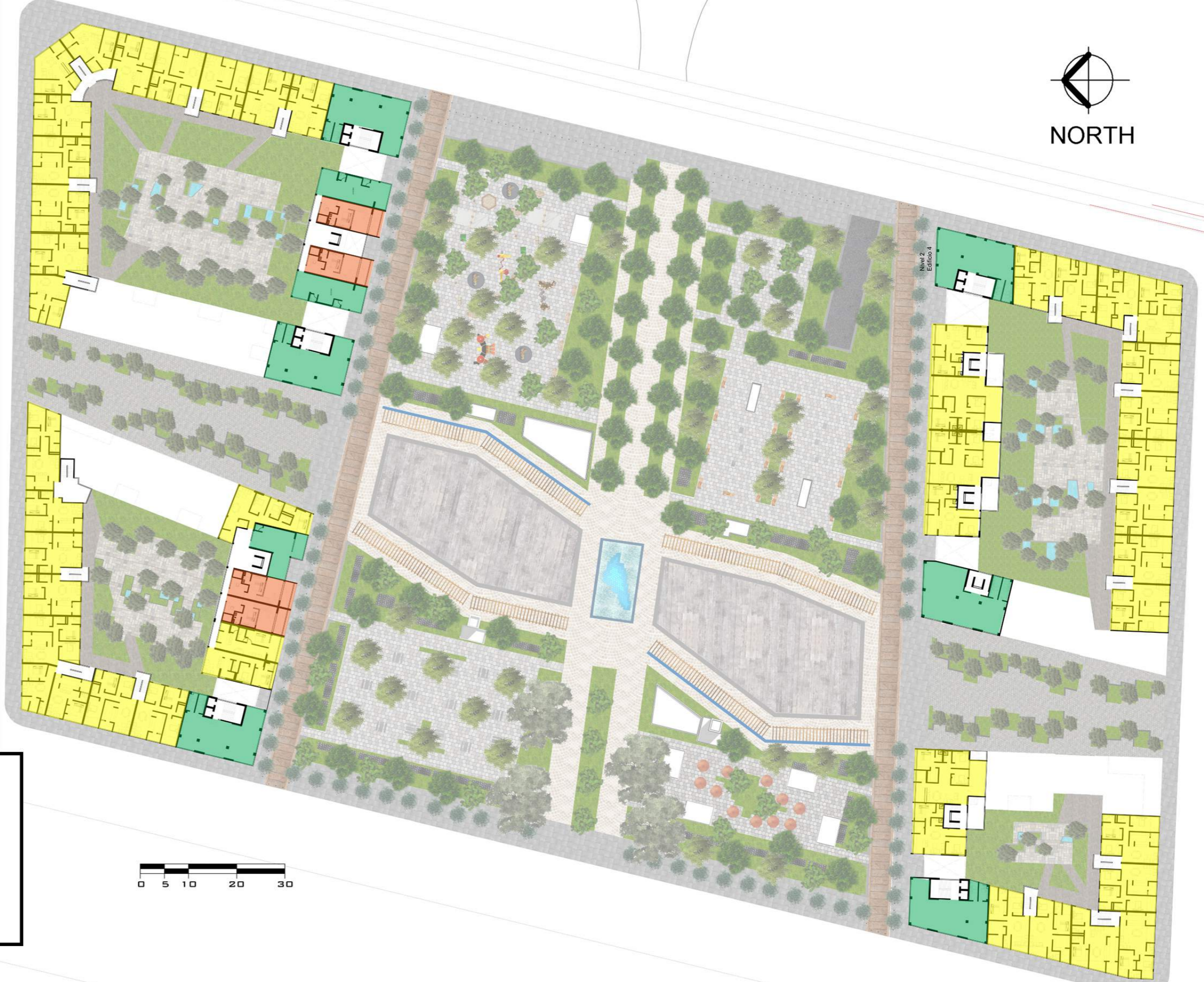

SYMBOLGY	
	COMMERCE
	OFFICE
	LOFT
	APPARTMENT
	SINGLE HOUSE



POLITECNICO DI MILANO  
FACOLTÀ DI INGEGNERIA EDILE - ARCHITETTURA  
MASTER IN ARCHITECTURAL ENGINEERING  
2013 - 2015

## EASTERN METROPOLITAN GREEN LUNG

Consuelo Concepción Velazco Sánchez 814744  
Fabio Andrés Ríos Franco 819782

Content:  
**Land Use. Third Level**  
Scale:  
**Graphic**

**A08**

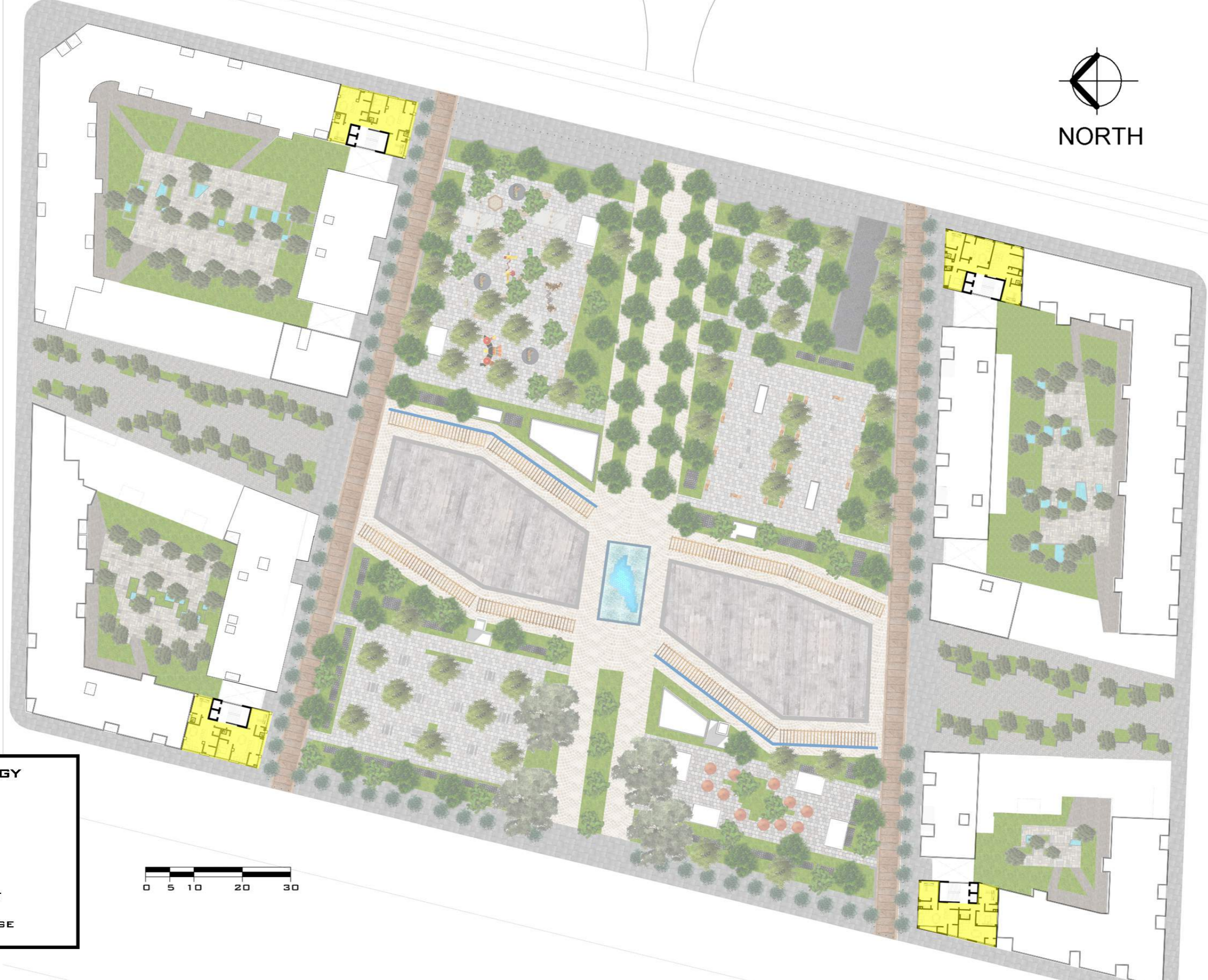

SYMBOLGY	
	COMMERCE
	OFFICE
	LOFT
	APPARTMENT
	SINGLE HOUSE



POLITECNICO DI MILANO  
FACOLTÀ DI INGEGNERIA EDILE - ARCHITETTURA  
MASTER IN ARCHITECTURAL ENGINEERING  
2013 - 2015

### EASTERN METROPOLITAN GREEN LUNG

Consuelo Concepción Velazco Sánchez 814744  
Fabio Andrés Ríos Franco 819782

Content:  
**Land Use. Fourth Level**  
Scale:  
**Graphic**

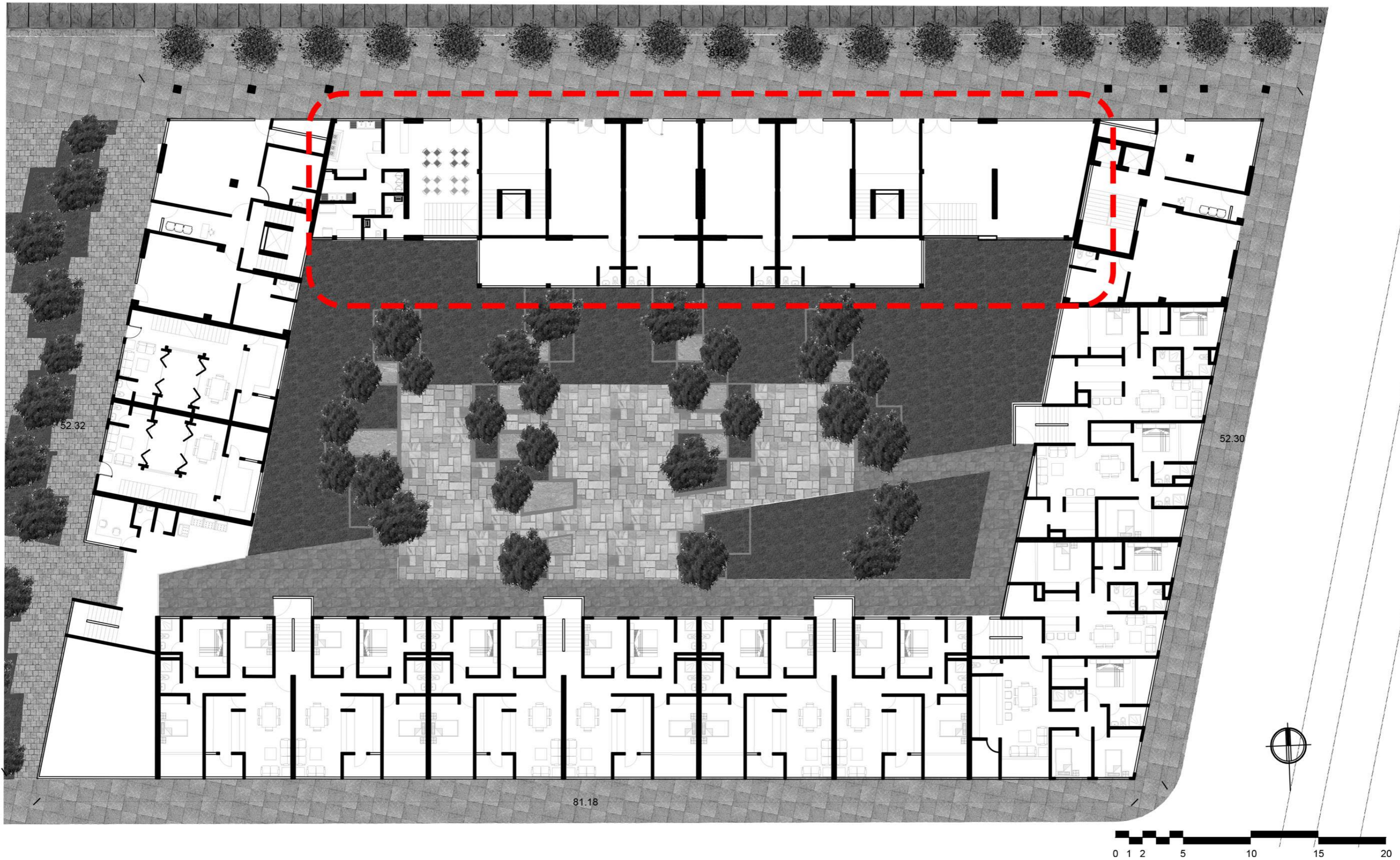

POLITECNICO DI MILANO  
 FACOLTÀ DI INGEGNERIA EDILE - ARCHITETTURA  
 MASTER IN ARCHITECTURAL ENGINEERING  
 2013 - 2015

## EASTERN METROPOLITAN GREEN LUNG

Consuelo Concepción Velazco Sánchez 814744  
 Fabio Andrés Ríos Franco 819782

Content:  
 Location Plan for Architectural Detailing  
 Scale:  
 Graphic

A10



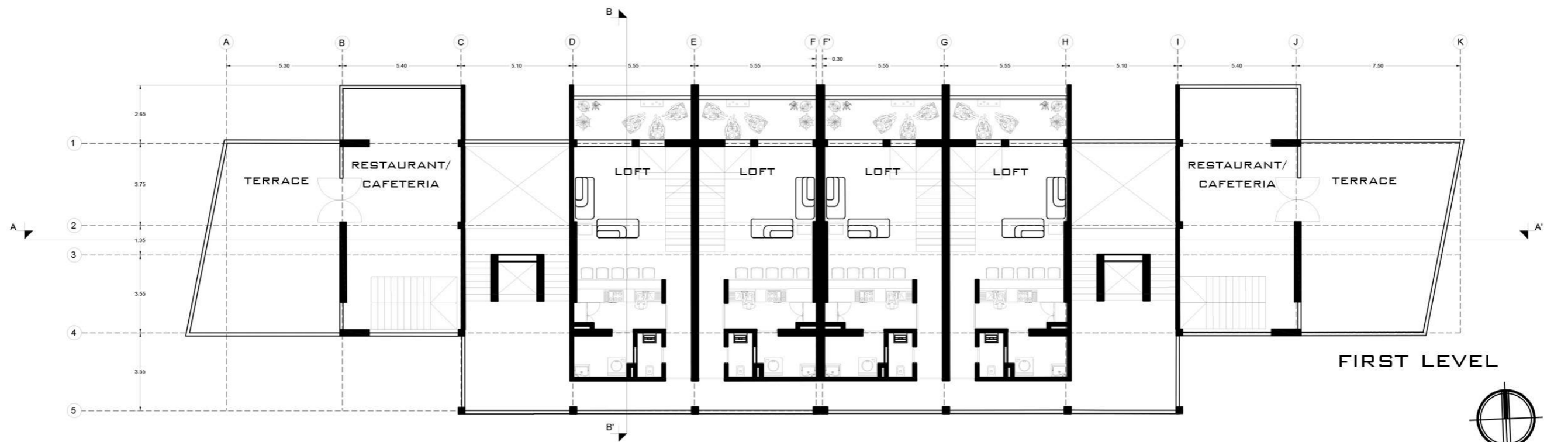
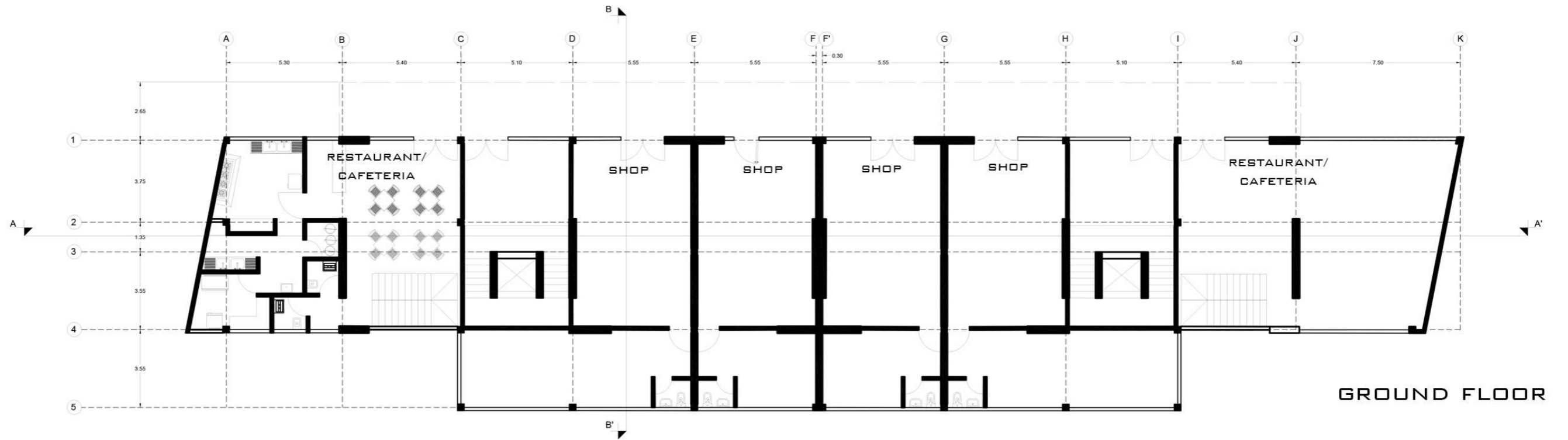

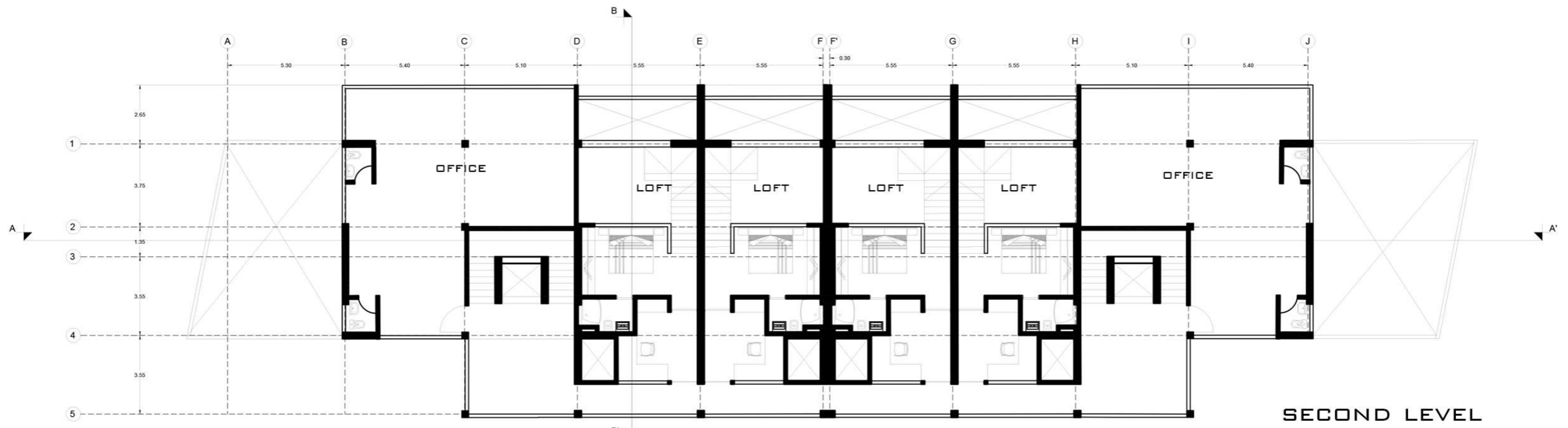

SECOND LEVEL

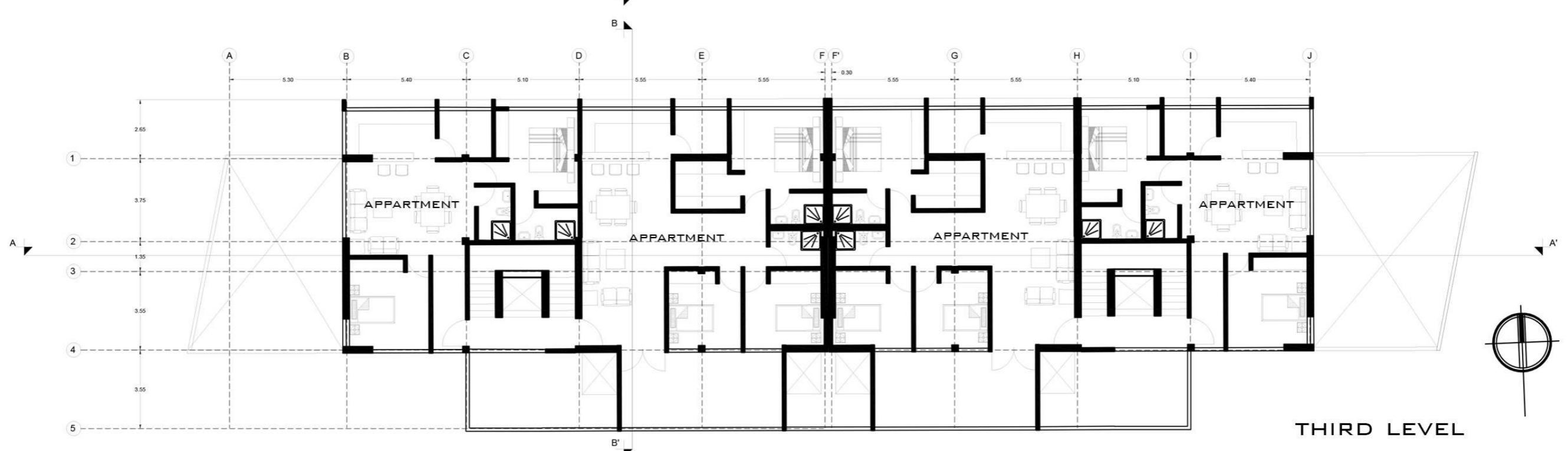

THIRD LEVEL



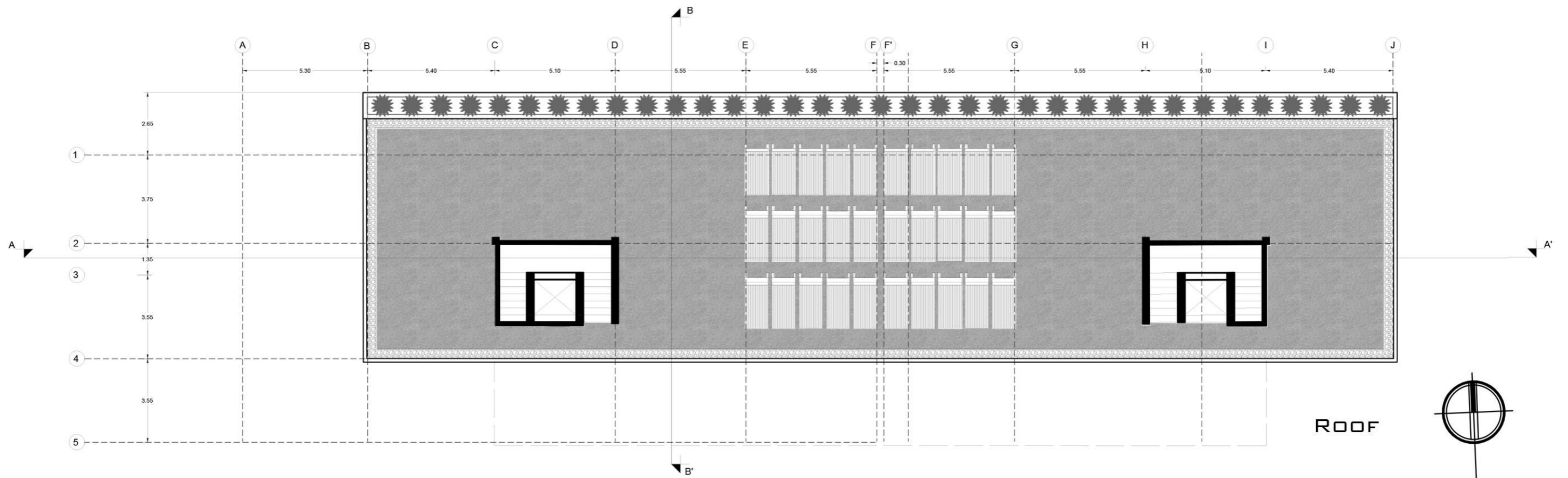

POLITECNICO DI MILANO  
 FACOLTÀ DI INGEGNERIA EDILE - ARCHITETTURA  
 MASTER IN ARCHITECTURAL ENGINEERING  
 2013 - 2015

## EASTERN METROPOLITAN GREEN LUNG

Consuelo Concepción Velazco Sánchez 814744  
 Fabio Andrés Ríos Franco 819782

Content:  
**Architectural Plans**  
 Scale:  
**1:200**

**A 1 3**



POLITECNICO DI MILANO  
FACOLTÀ DI INGEGNERIA EDILE - ARCHITETTURA  
MASTER IN ARCHITECTURAL ENGINEERING  
2013 - 2015

## EASTERN METROPOLITAN GREEN LUNG

Consuelo Concepción Velazco Sánchez 814744  
Fabio Andrés Ríos Franco 819782

Content:  
**Main Elevation / Blinds up**  
Scale:  
**1:150**

**A 1 4**

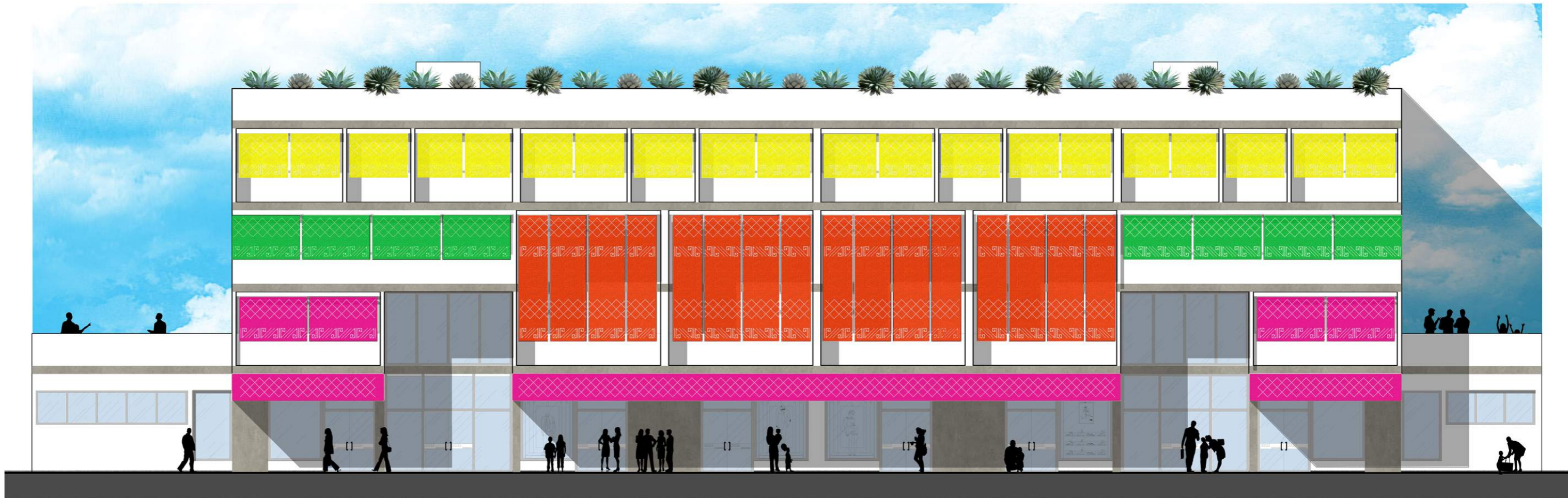

POLITECNICO DI MILANO  
FACOLTÀ DI INGEGNERIA EDILE - ARCHITETTURA  
MASTER IN ARCHITECTURAL ENGINEERING  
2013 - 2015

## EASTERN METROPOLITAN GREEN LUNG

Consuelo Concepción Velazco Sánchez 814744  
Fabio Andrés Ríos Franco 819782

Content:  
**Main Elevation / Blinds down**  
Scale:  
**1:150**

**A15**



POLITECNICO DI MILANO  
FACOLTÀ DI INGEGNERIA EDILE - ARCHITETTURA  
MASTER IN ARCHITECTURAL ENGINEERING  
2013 - 2015

Consuelo Concepción Velazco Sánchez 814744  
Fabio Andrés Ríos Franco 819782

Content:  
**Section A - A'**  
Scale:  
**1:150**

**A16**

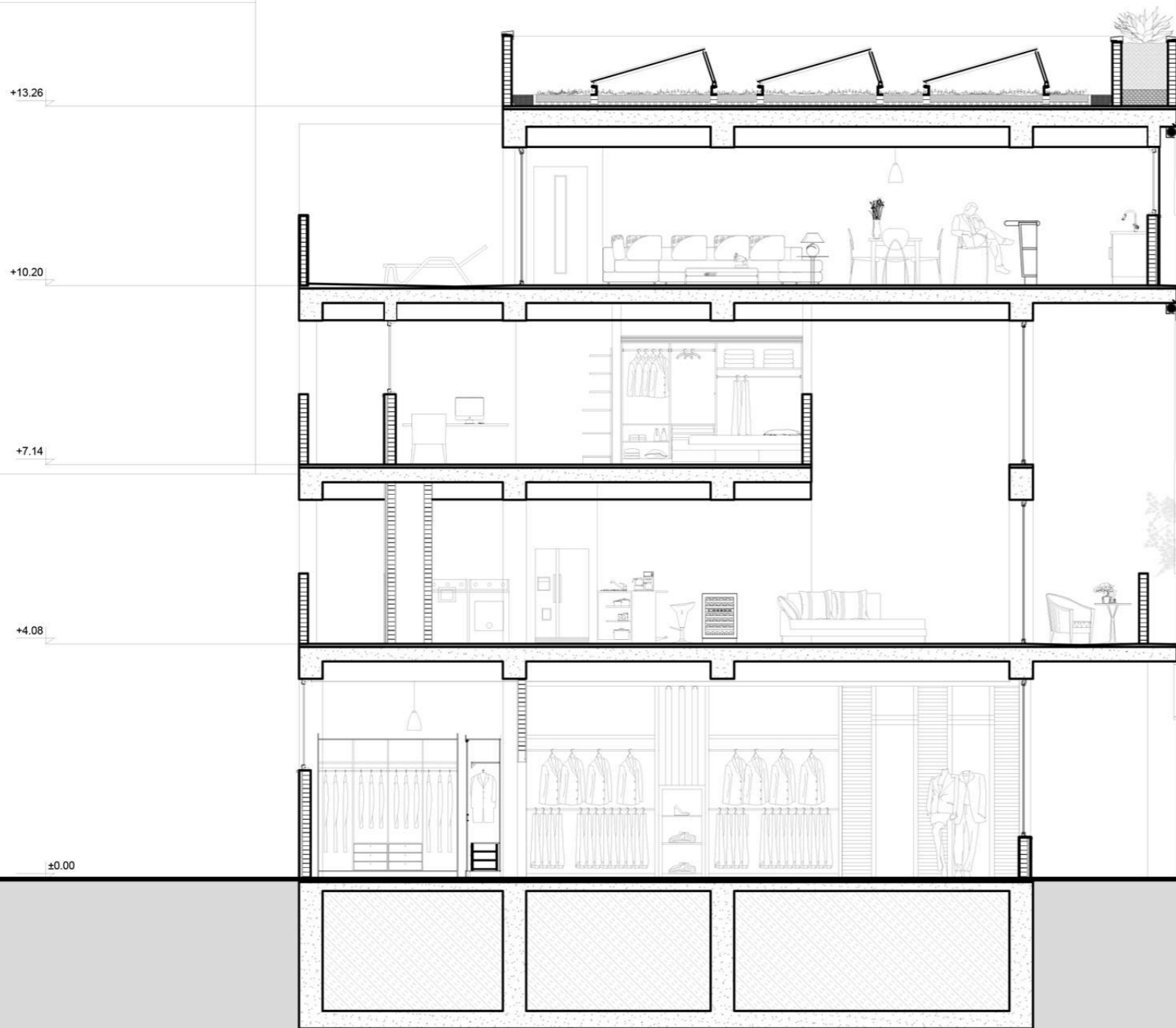

POLITECNICO DI MILANO  
 FACOLTÀ DI INGEGNERIA EDILE - ARCHITETTURA  
 MASTER IN ARCHITECTURAL ENGINEERING  
 2013 - 2015

## EASTERN METROPOLITAN GREEN LUNG

Consuelo Concepción Velazco Sánchez 814744  
 Fabio Andrés Ríos Franco 819782

Content:  
**Section B - B'**  
 Scale:  
**1:100**

**A 17**

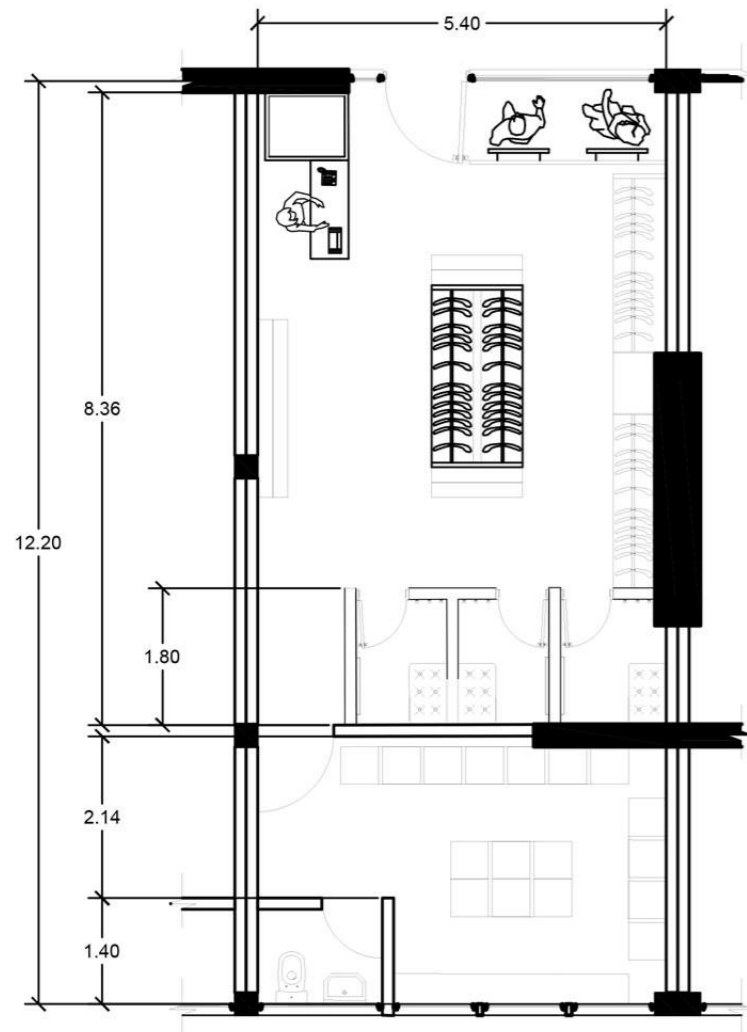

SHOP

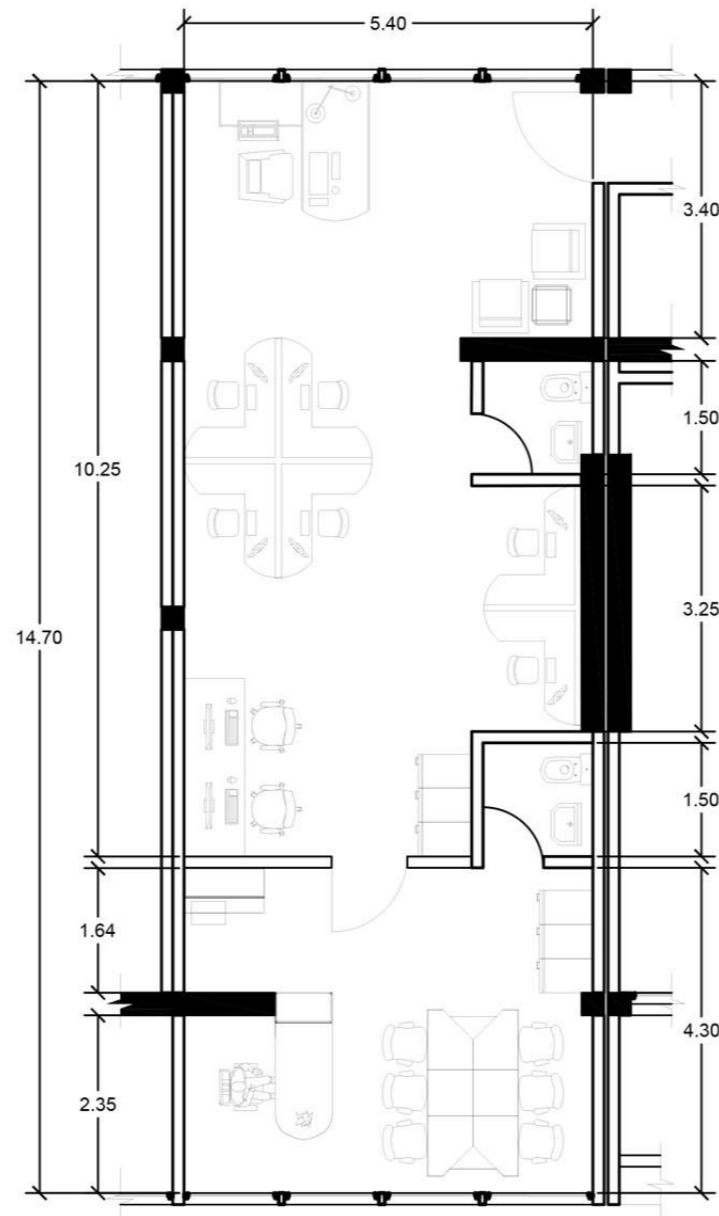

OFFICE TYPE A

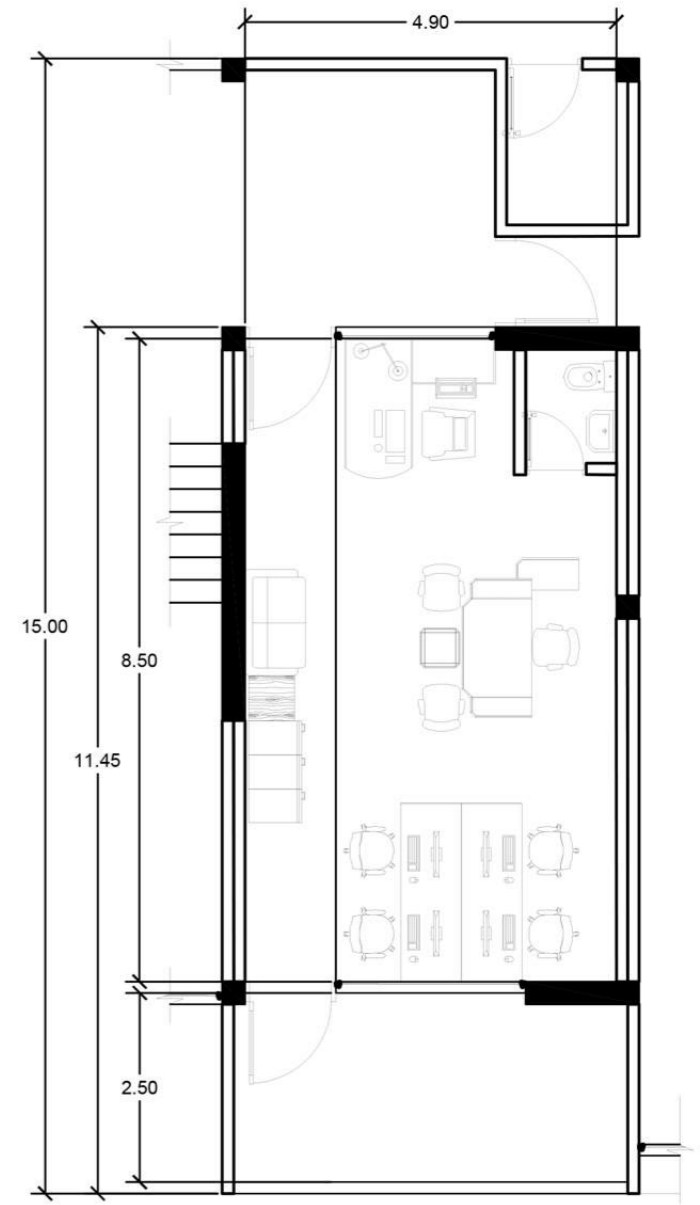

OFFICE TYPE B





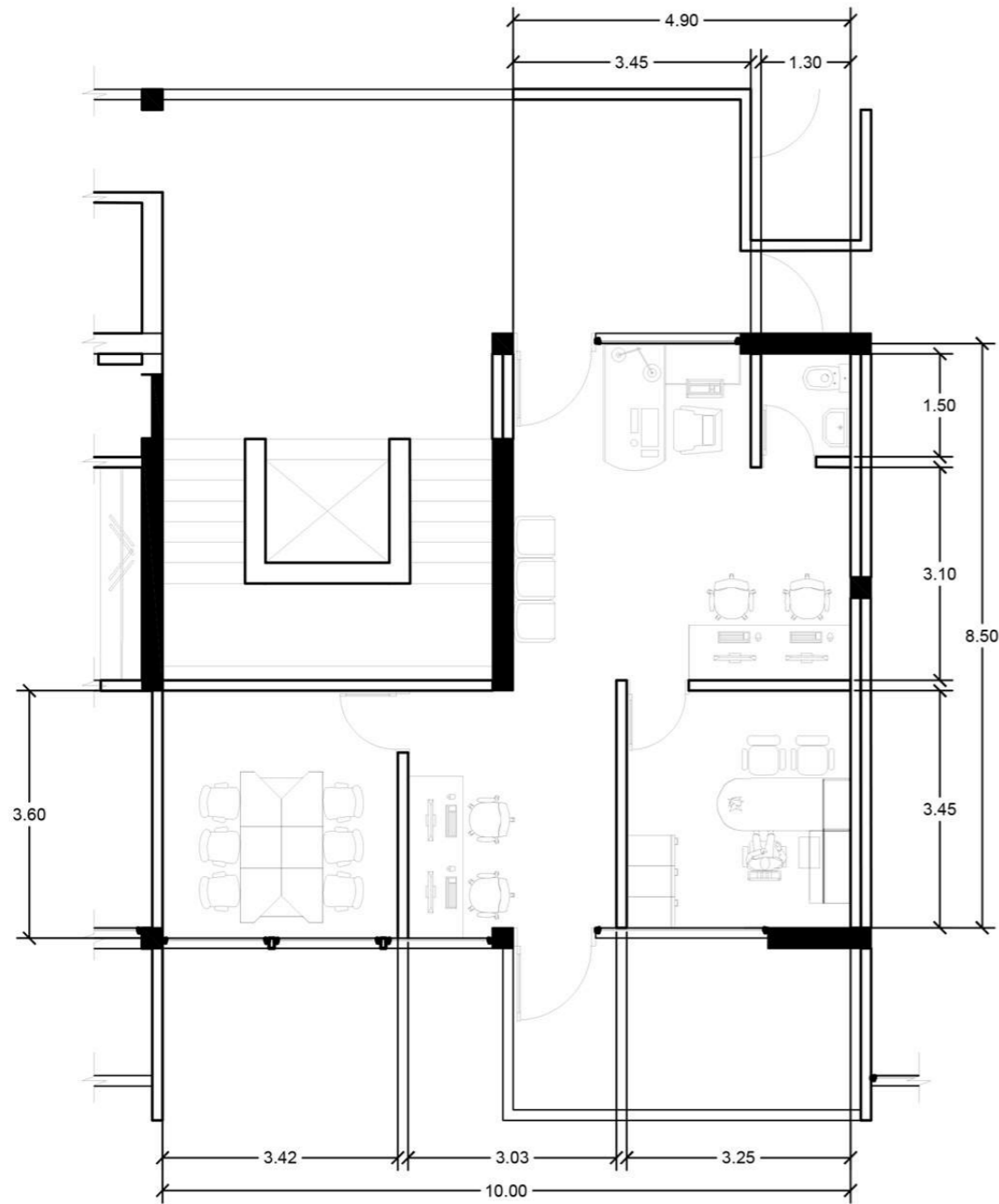

OFFICE TYPE C

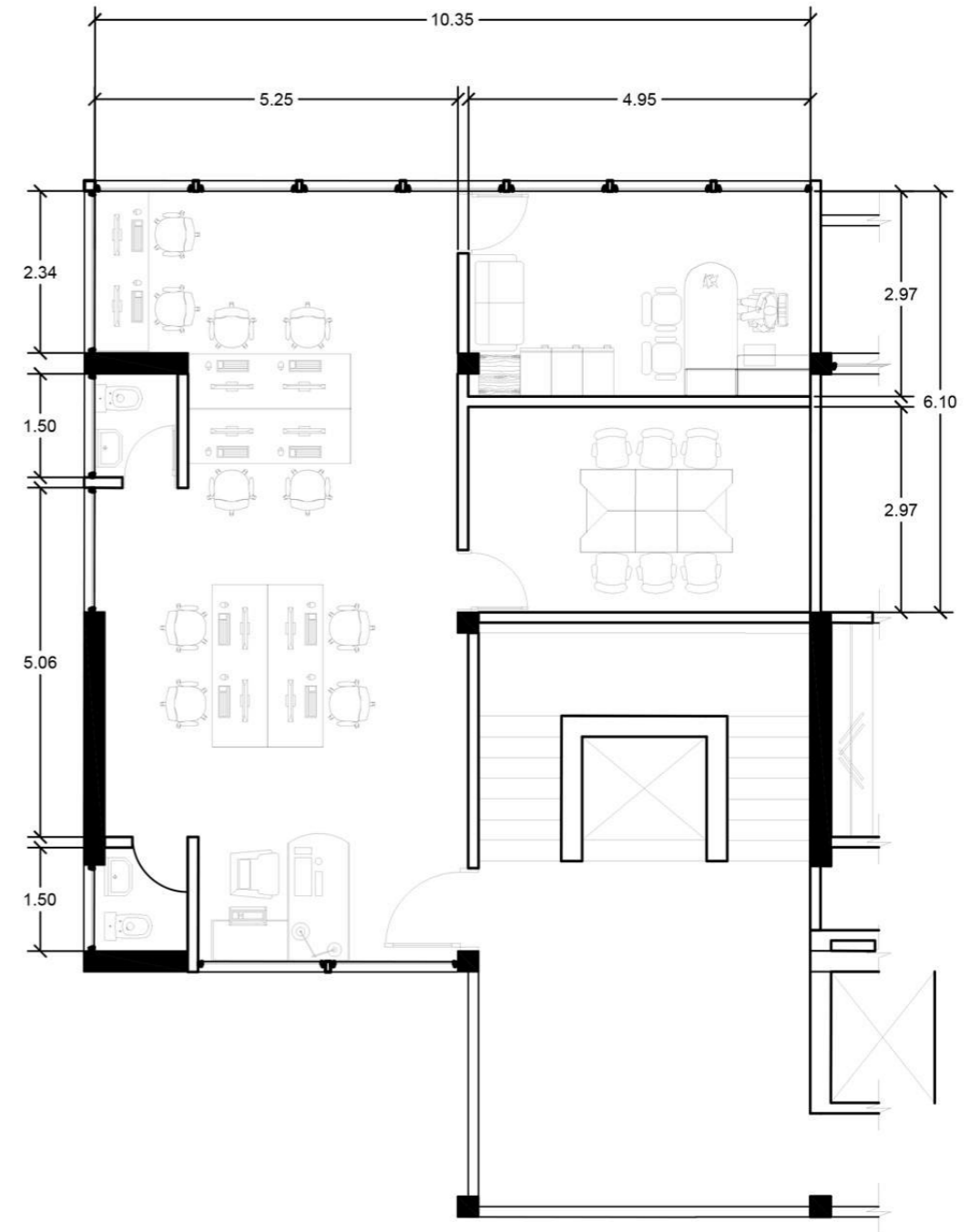

OFFICE TYPE D



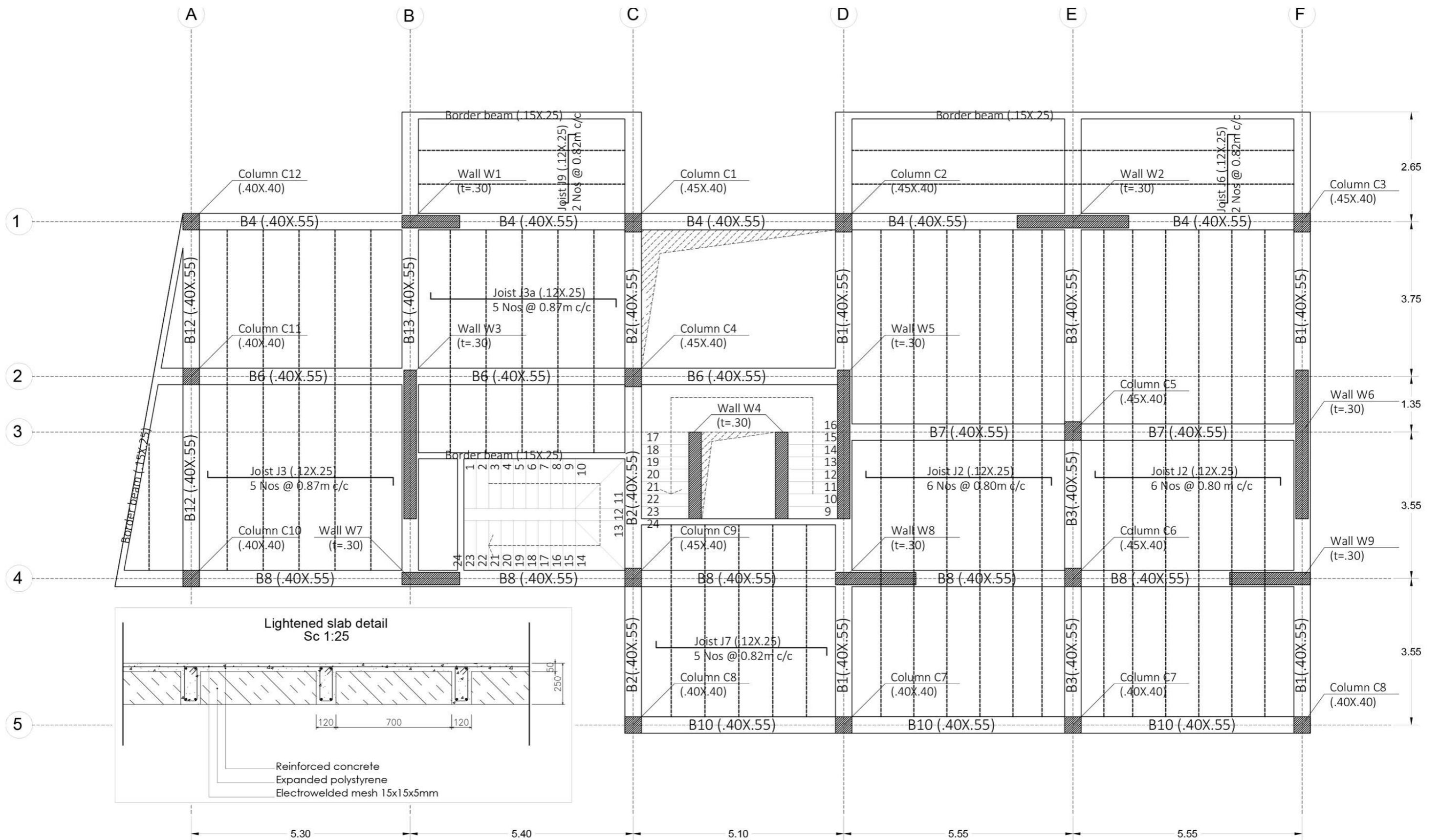

STRUCTURAL PLANS  
FLOOR 1  
SL +4.03



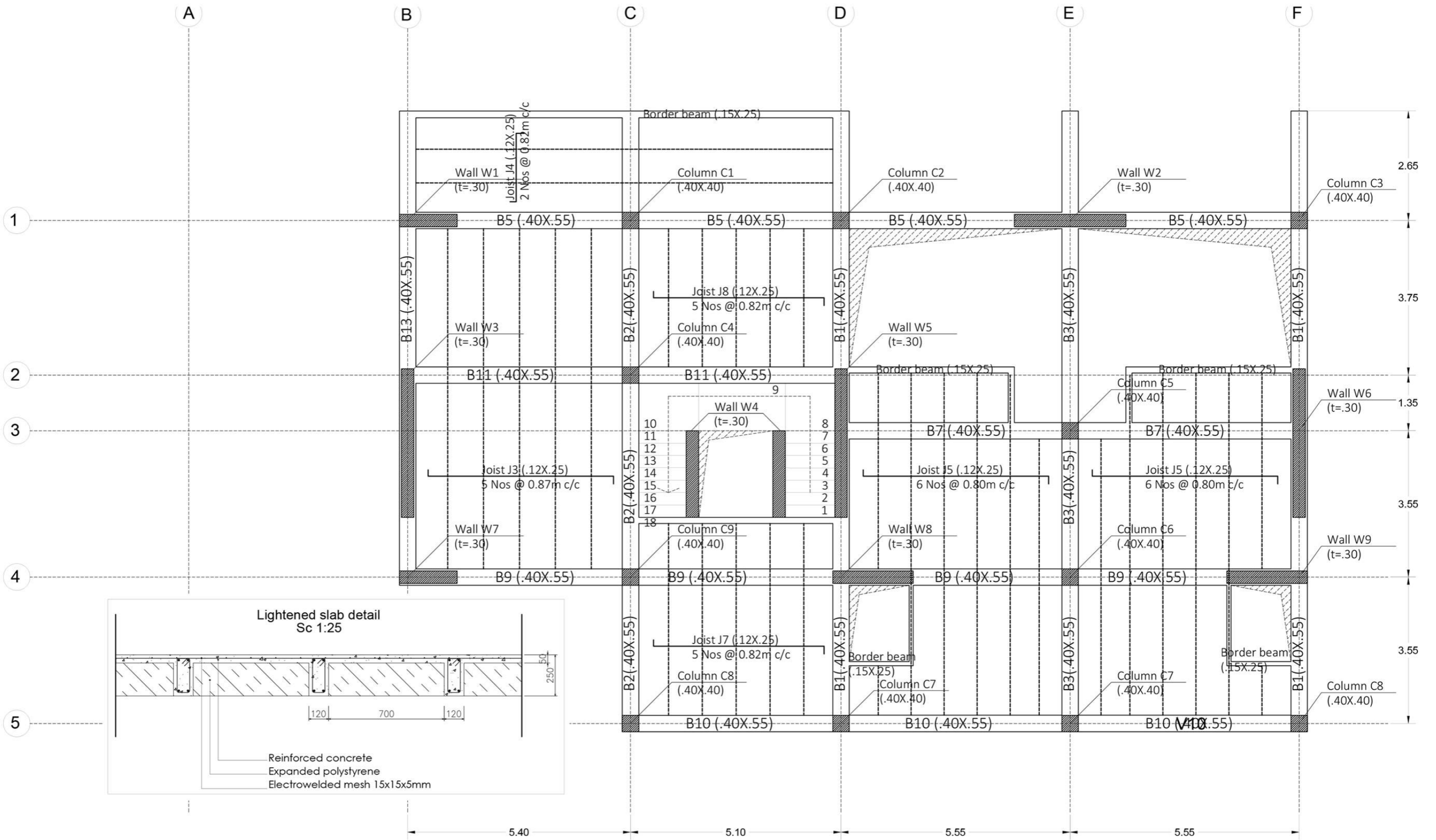

STRUCTURAL PLANS  
FLOOR 2  
SL +4.03



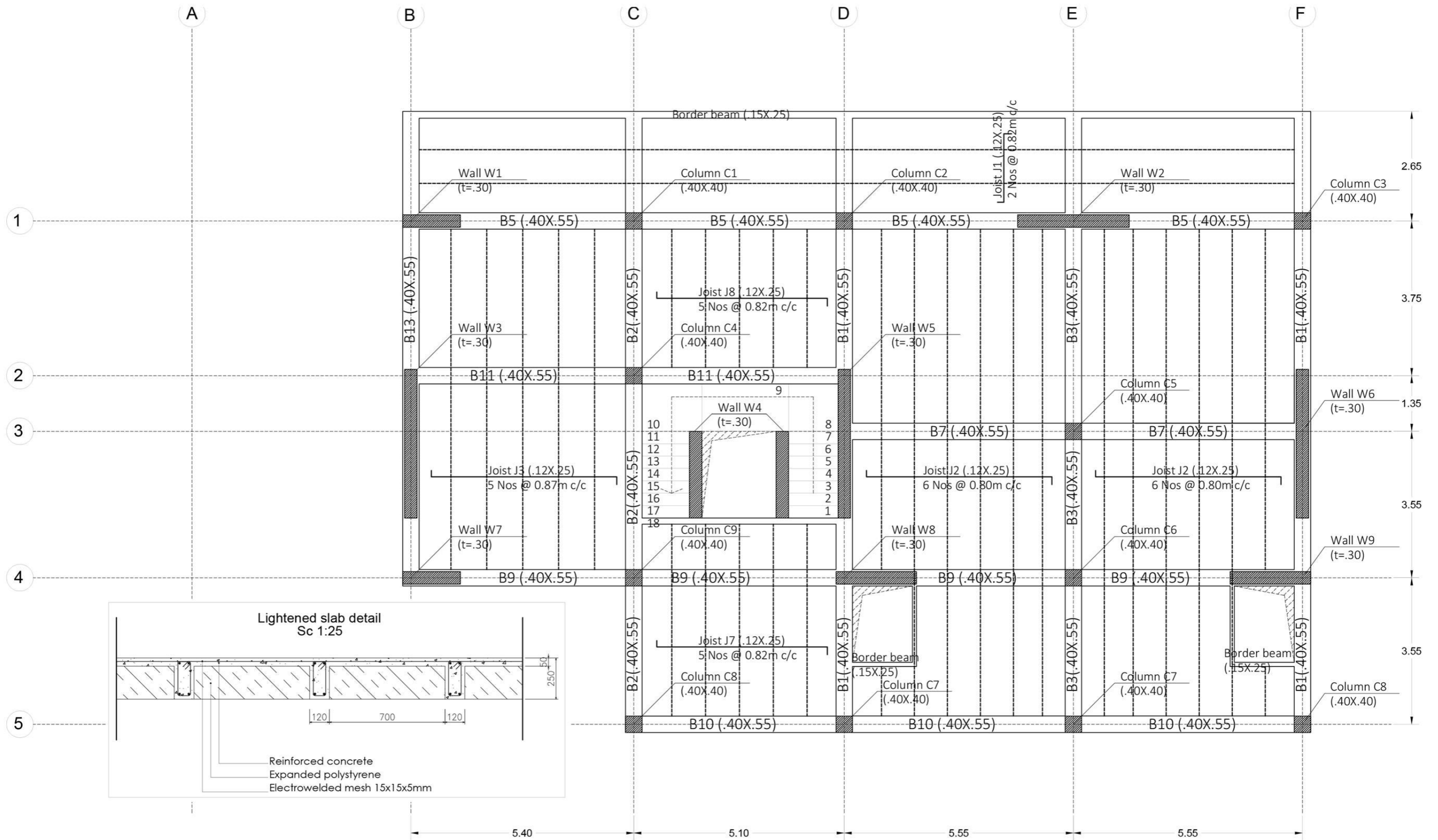

STRUCTURAL PLANS  
FLOOR 3  
SL +10.15



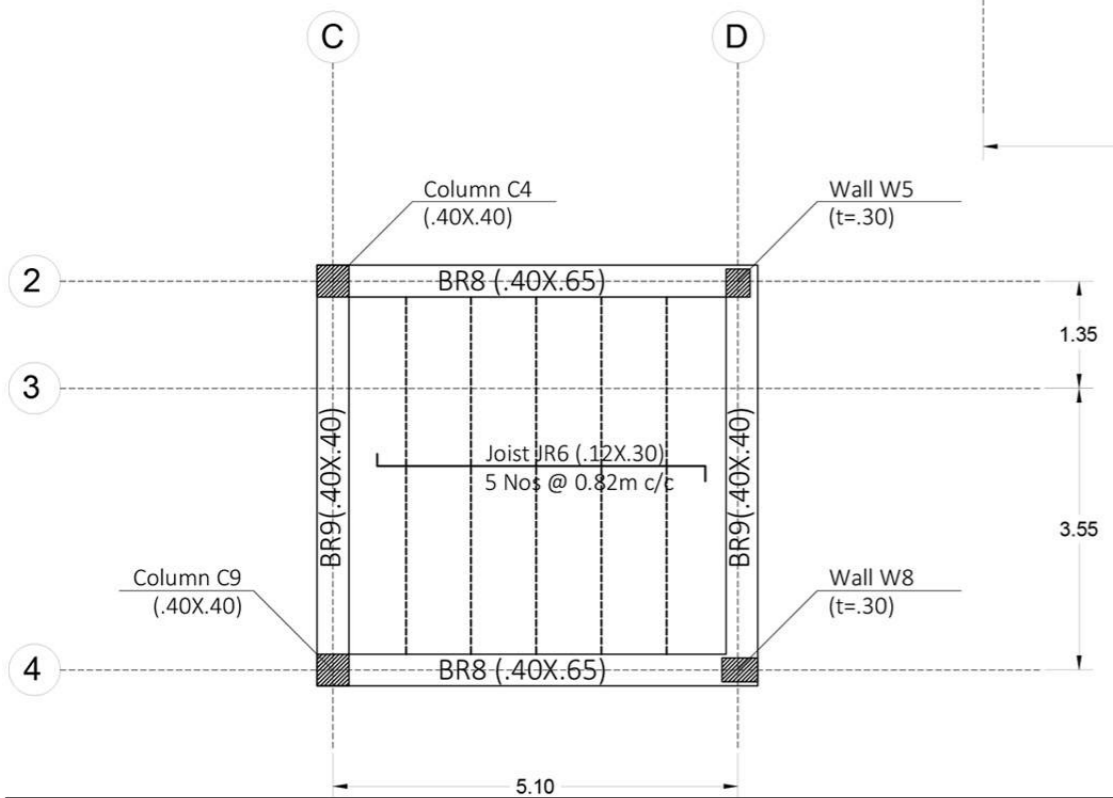
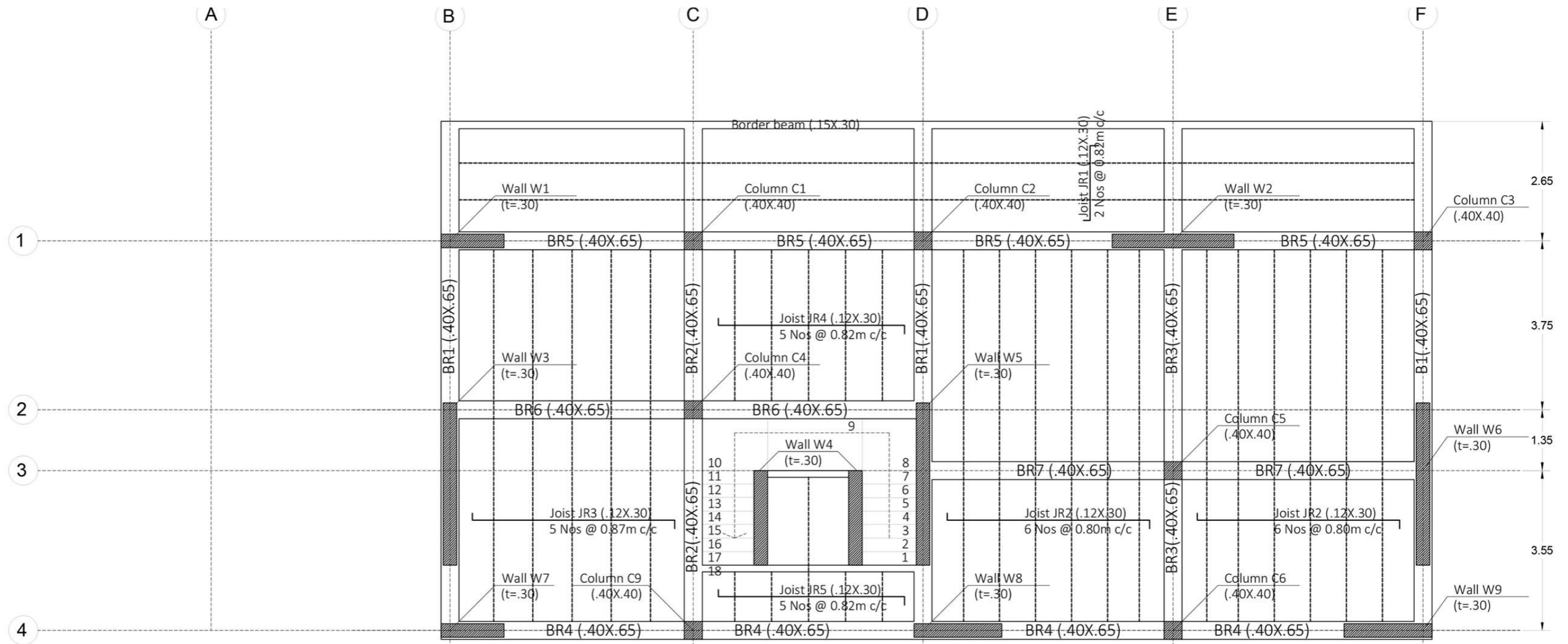

STRUCTURAL PLANS  
ROOF  
SL +13.21

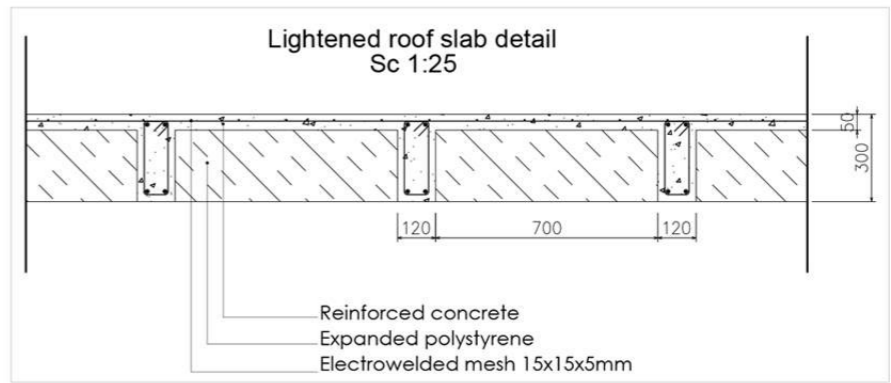

STRUCTURAL PLANS  
SL +16.27



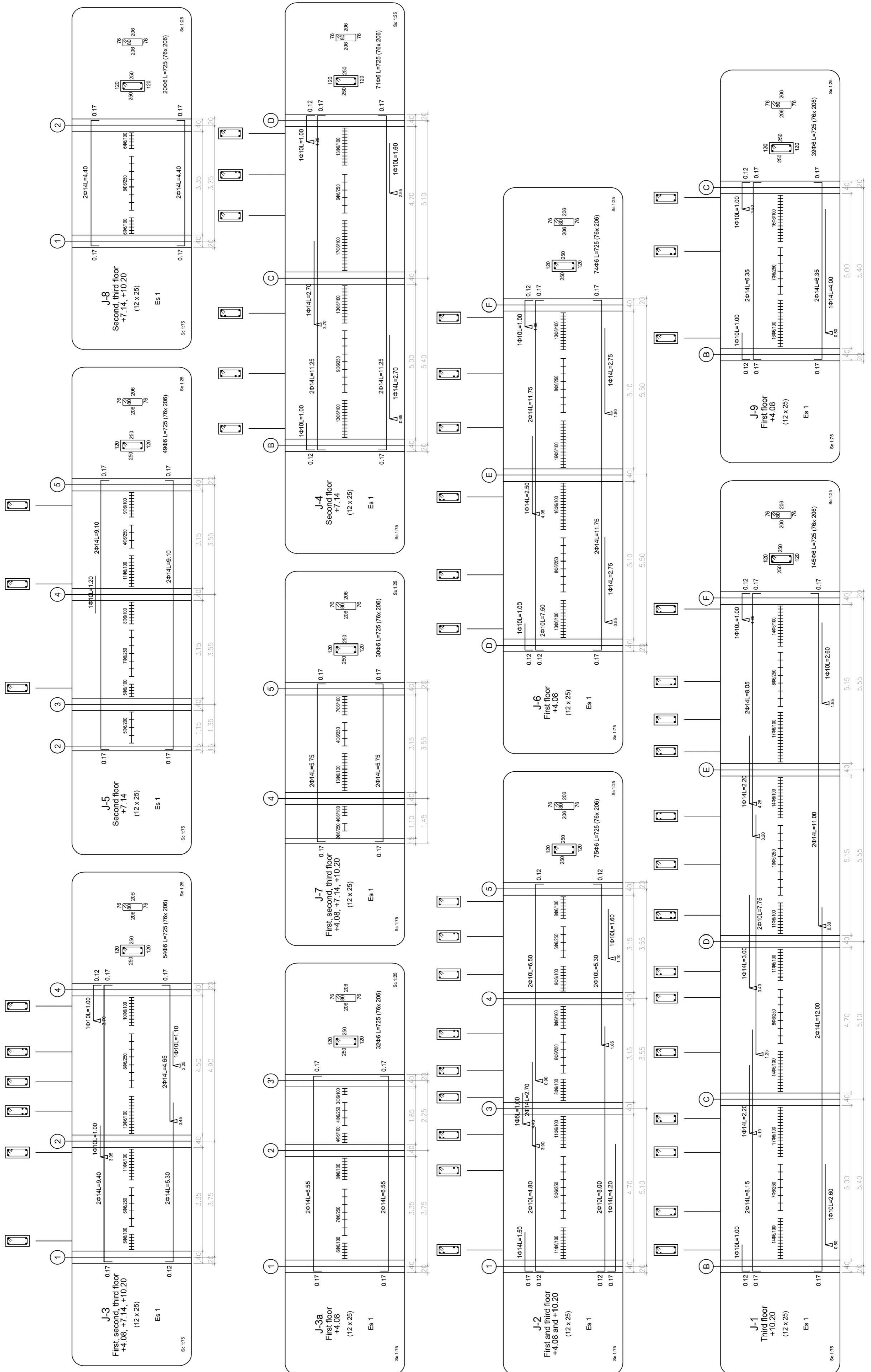

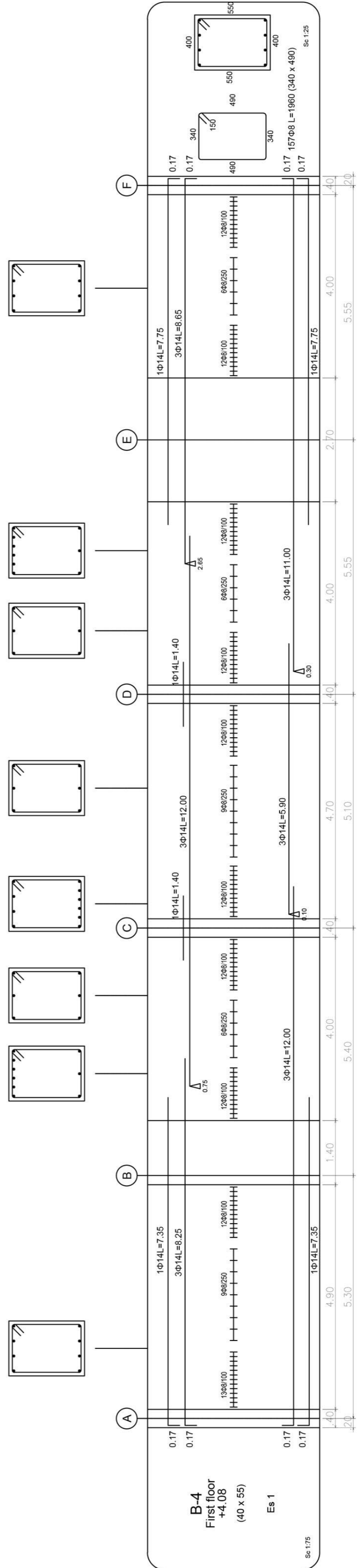
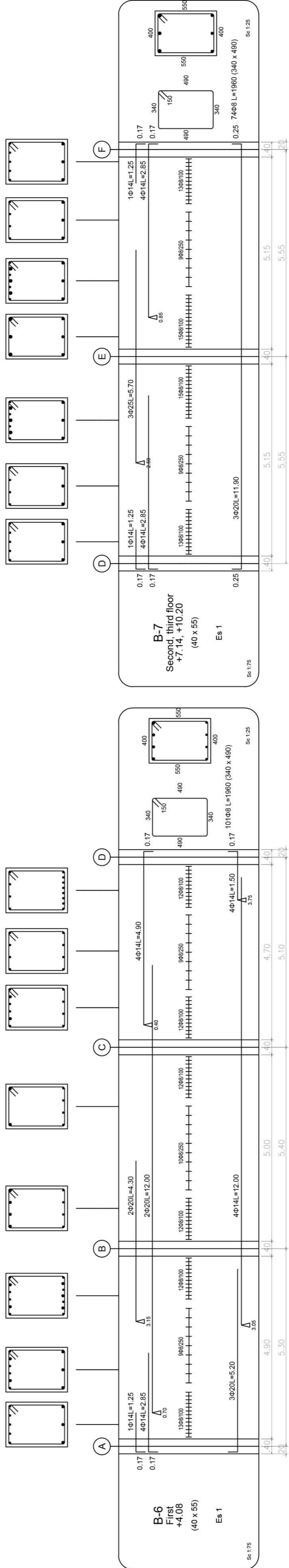
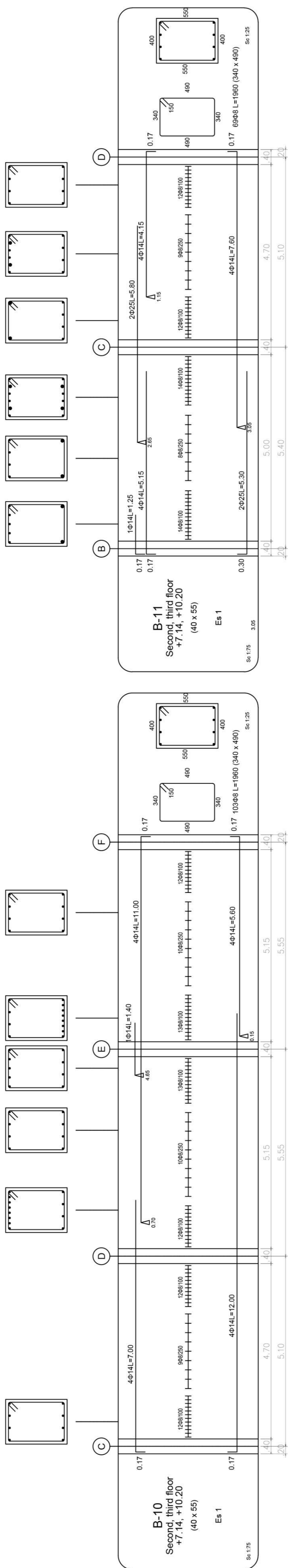

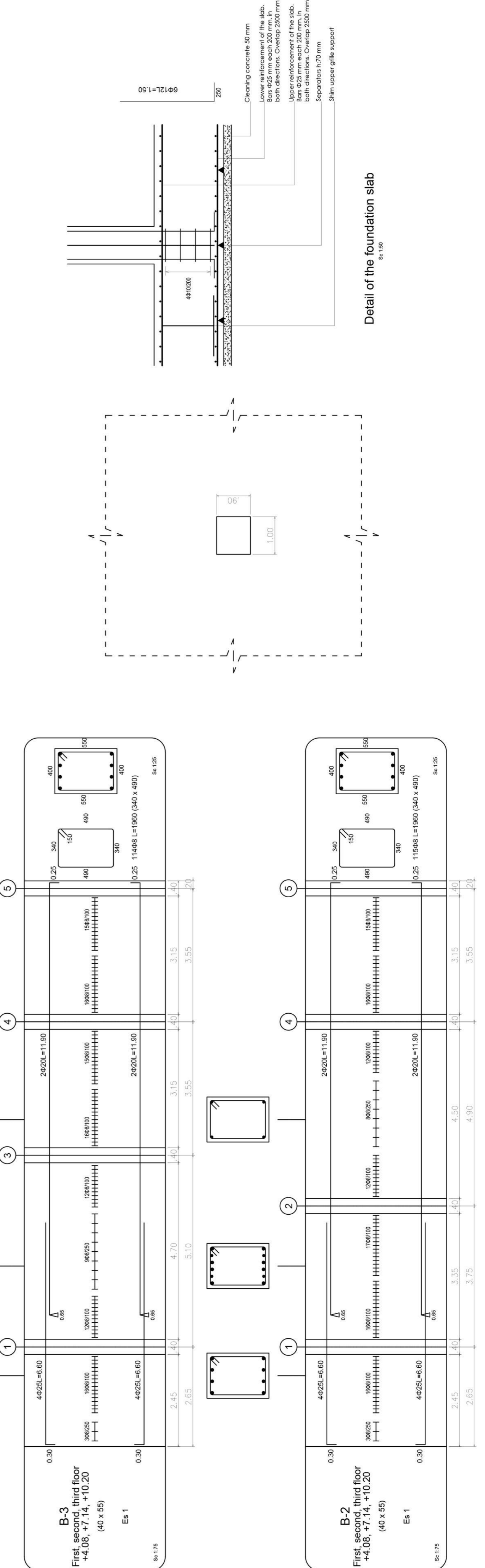
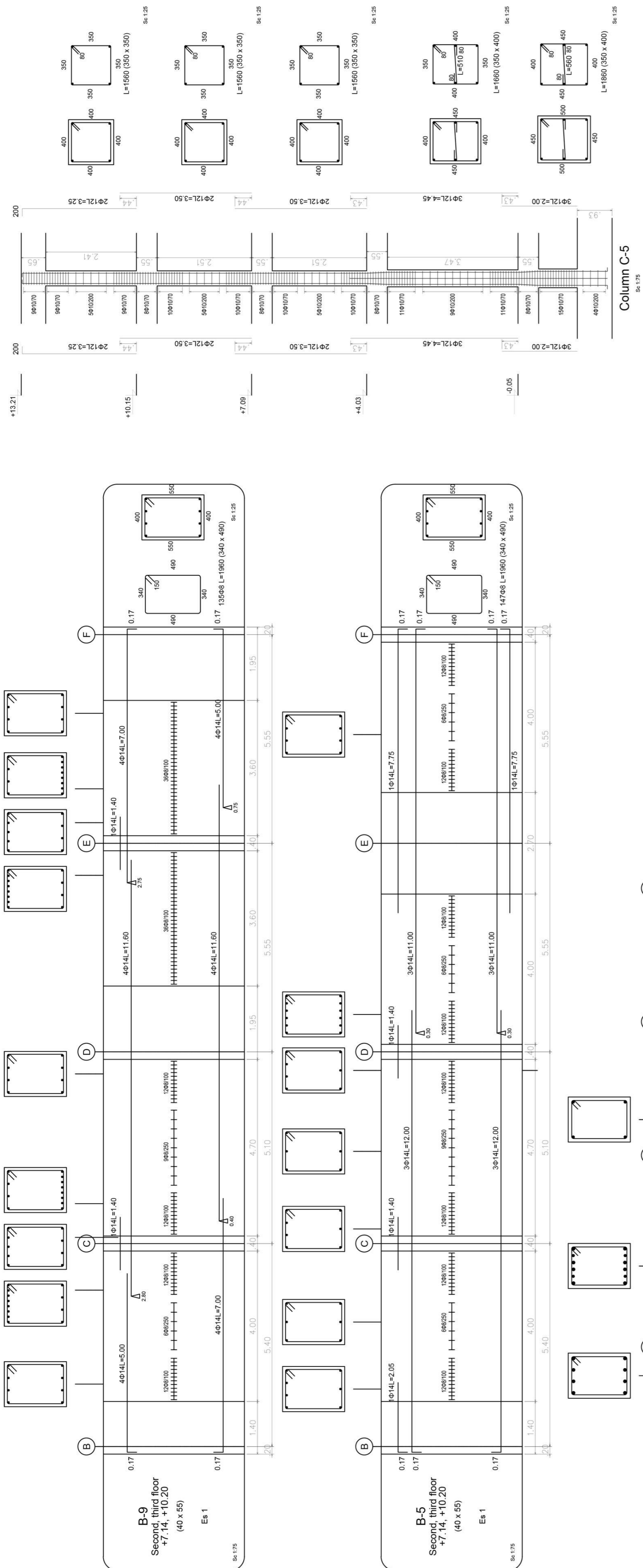

Detail of the foundation slab  
Sc. 1:50



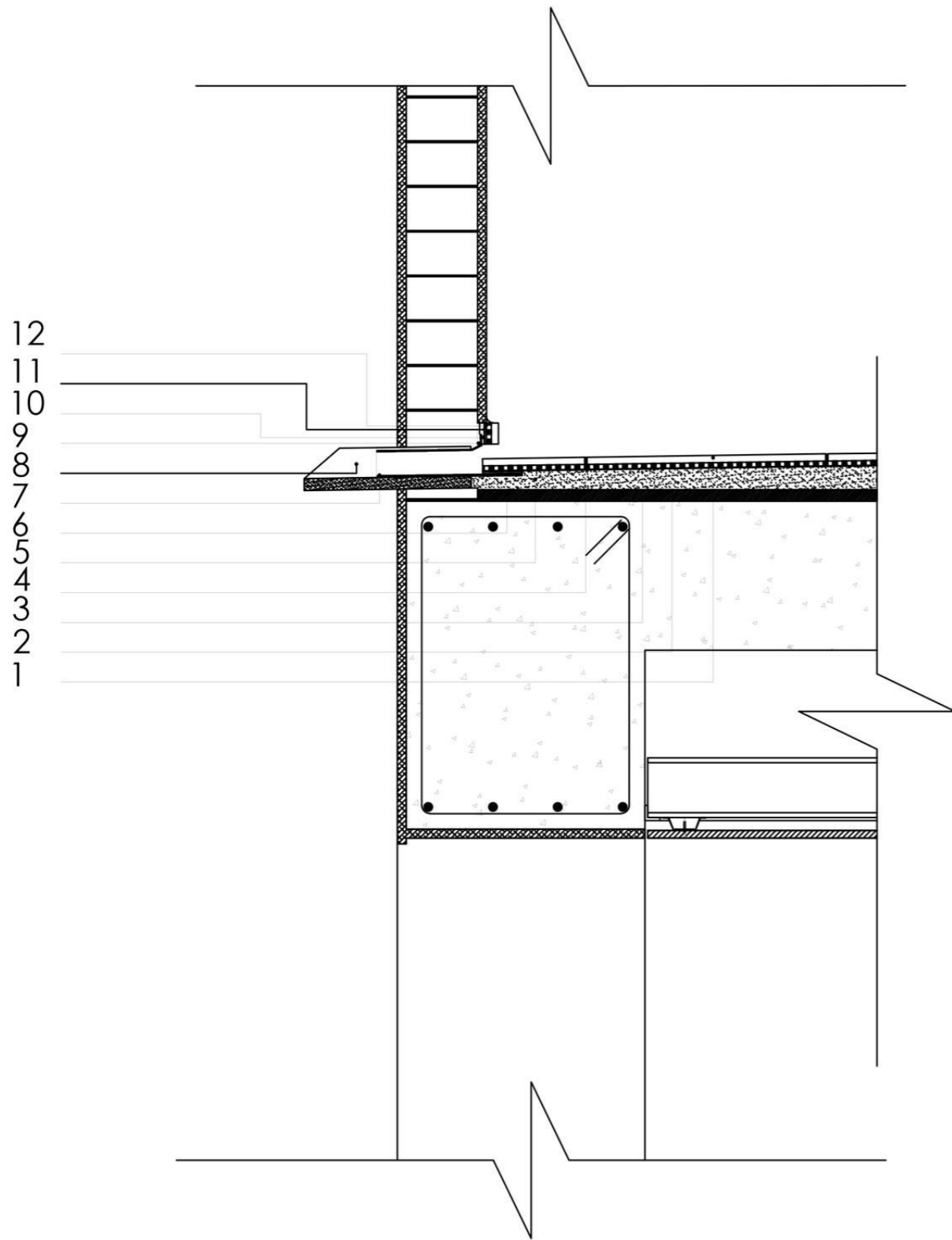

- 1.- Ceramic tile
- 2.- Cementitious adhesive applied with notched throwel 8 x 8 mm
- 3.- Mapelastic Aquadefense: Waterproof flexible liquid membrane
- 4.- 4.0 mm grout. High performance cementitious mortar modified with polymers
- 5.- Cementitious mortar, minimum 30 mm.
- 6.- Mapesilent panel: sound-proofing panel. 13 mm.
- 7.- Drain Front. Plastic TPE angular pipe union for balconies and terraces. 57x48x347 mm.
- 8.- Cement based gargoyle. 100x70x280 mm. Internal space: 60 mm.
- 9.- Glue the angular pipe with Adesilex PG4 Epoxy adhesive. 2 mm.
- 10.- Cover of the angular pipe with Adesilex PG4 Epoxy adhesive. 2 mm. sprinkled with a fine layer of 0.5 spheroid quartz ( remove the excess.
- 11.- Mapeband: Rubber tape with alkali resistant fabric for cementitious waterproofing systems.
- 12.- Cover of the rubber tape with Adesilex PG4 Epoxy adhesive. 2 mm

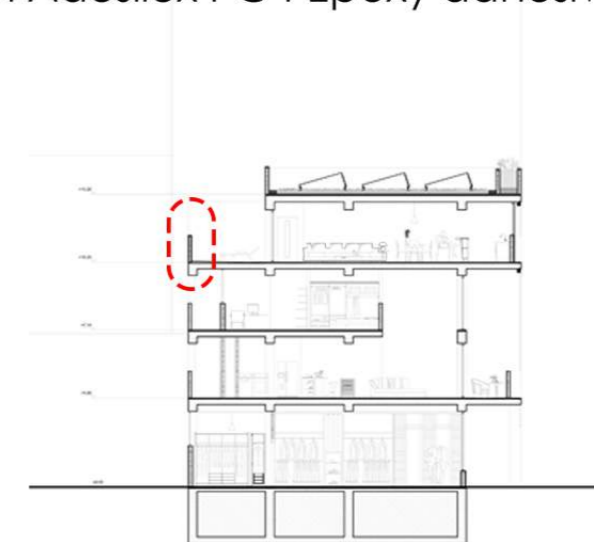

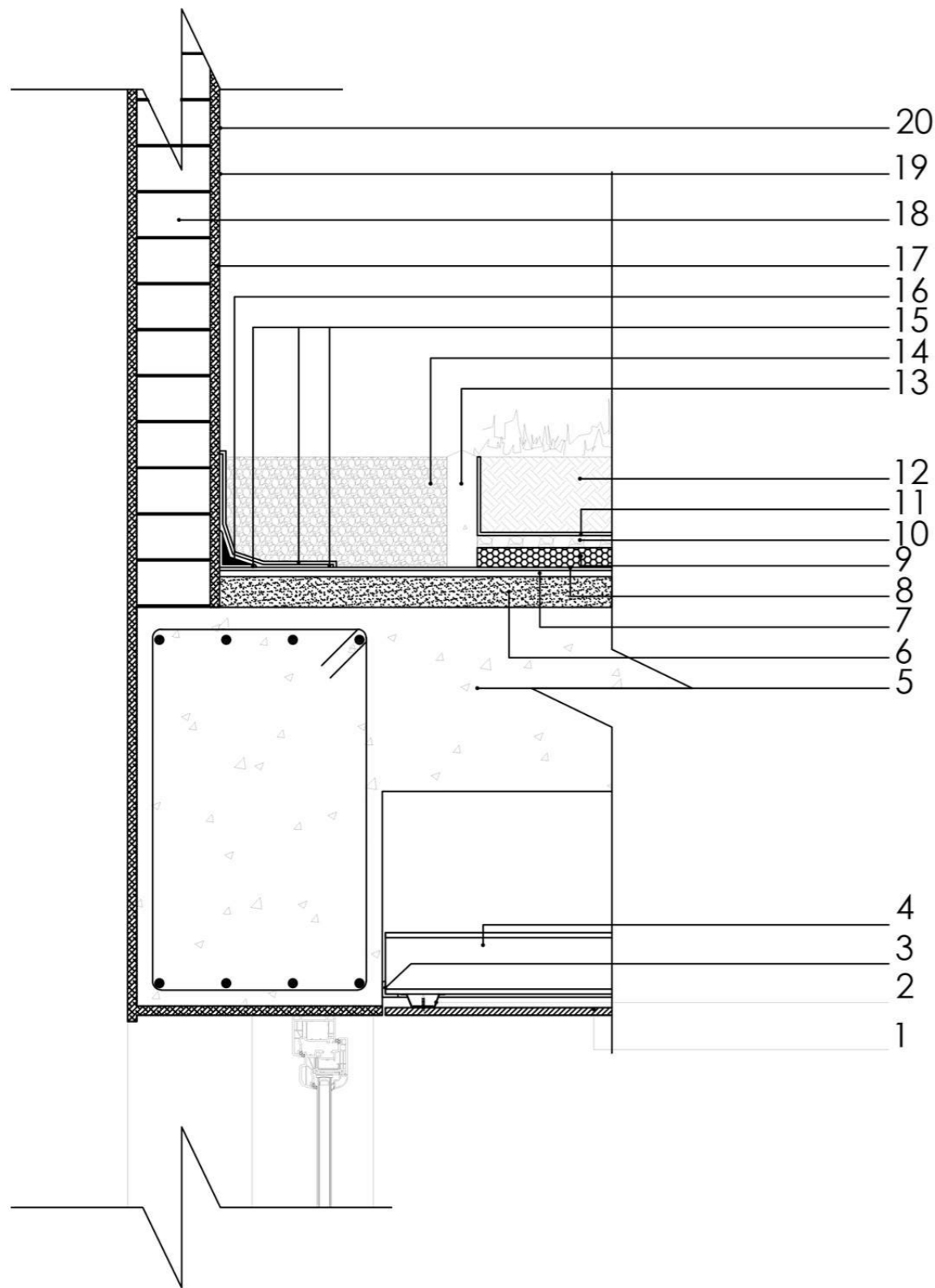

- 1.- Gypsum board for false ceiling. Thickness 12 mm.
- 2.- Furring channel. Cal. 26.
- 3.- Aluminum clamping angle. 1"
- 4.- Loading channels. Cal. 26, 4"
- 5.- Reinforced concrete slab
- 6.-Cementitious mortar, minimum 30 mm.
- 7.- Styrbase stick®. Bituminous waterproofing membrane. 10 mm.
- 8.- Sopralene Flam Jardin®. Anti-root bituminous membrane. 5 mm.
- 9.- Water-retention panel of rock-wool. 32 mm.
- 10.- Natural aggregate. 20 mm.
- 11.- Soprafiltre®. Polypropylene filtering layer. 5 mm.
- 12.- Composted sludge substrate. 120 mm.
- 13.- Prefabricated concrete dividing element.
- 14.- Separating gravel edge. 180 mm.
- 15.- Alsan Flasing Jardin® watertight bitumen-polyurethane resin.
- 16.- Reinforcement fleece
- 17.- Cementitious plaster.
- 18.- Problock®. Cementitious block (Thickness= 120 mm)
- 19.- Primer, base coat.
- 20.- Final painting coat.

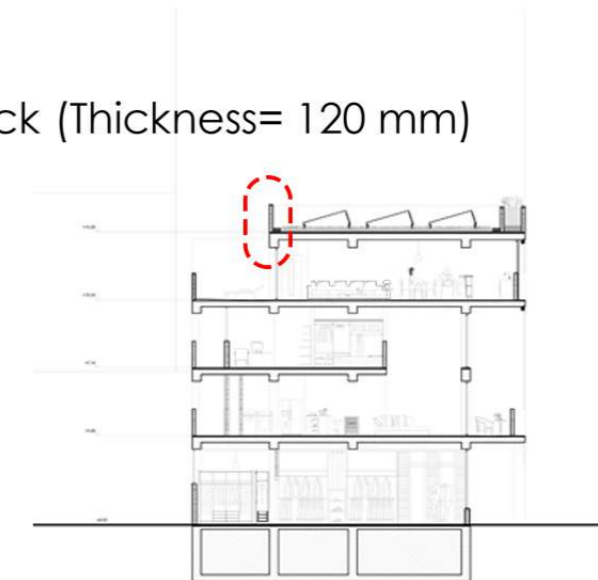

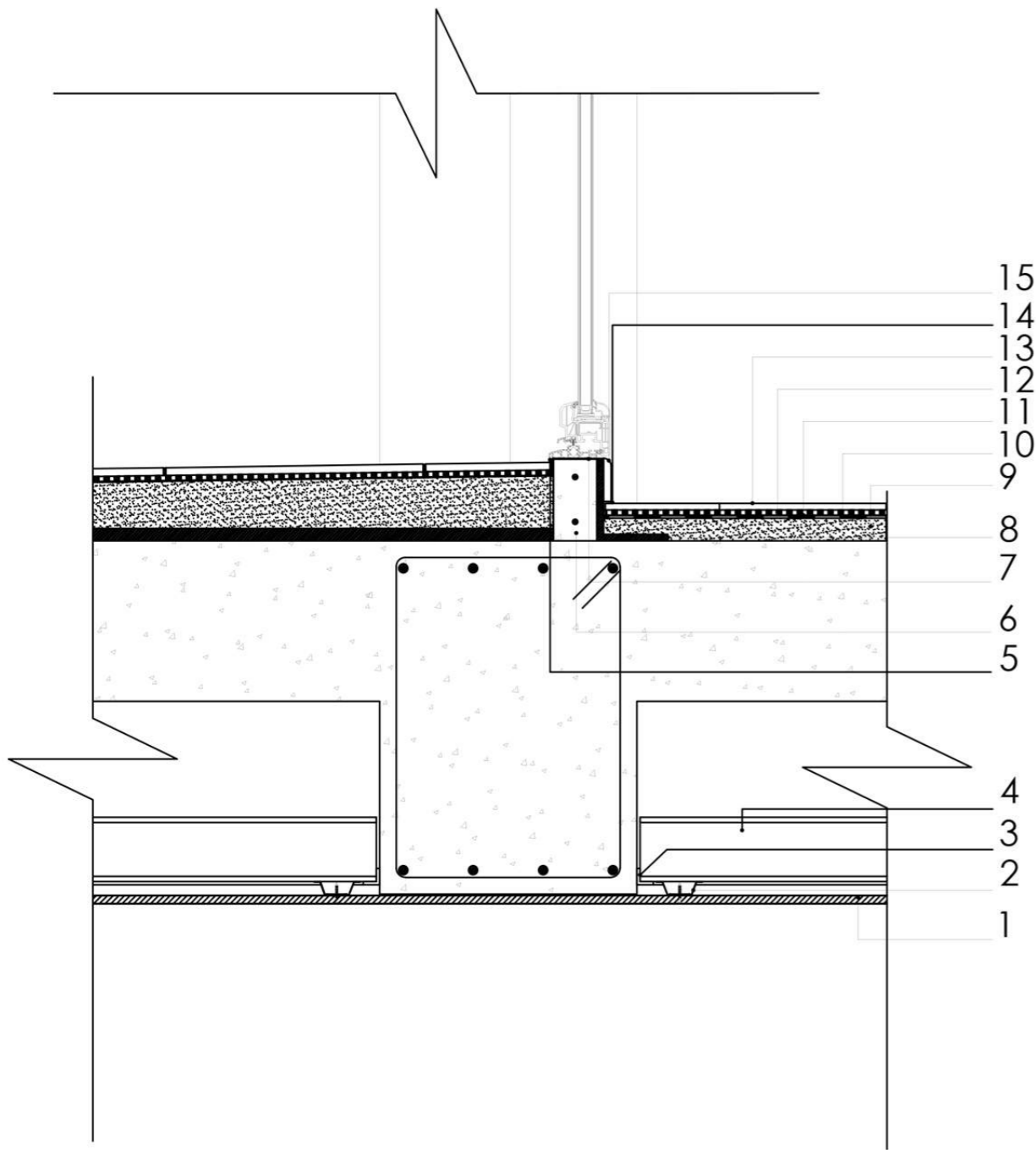

- 1.- Gypsum board for false ceiling. Thickness 12 mm.
- 2.- Furring channel. Cal. 26.
- 3.- Aluminum clamping angle. 1"
- 4.- Loading channels. Cal. 26, 4"
- 5.- Mapecil AC. Acetic cross-linking waterproof silicon sealant. 5 mm.
- 6.- Reinforced concrete member. 70x125 mm.
- 7.- Mapelastic Aquadefense: Waterproof flexible liquid membrane.
- 8.- Polyethylene acoustic insulating membrane in between the floor and wall. Overlap 70 mm.
- 9.- Cementitious mortar. Min 30 mm
- 10.- Mapesonic CR. Sound proofing insulating sheet or rubber and cork. Thickness 4 mm.
- 11.- Ultrabond Eco V4 SP. Acrylic adhesive.
- 12.- Cementitious adhesive applied with notched trowel 8 x 8 mm
- 13.- Ceramic tile.
- 14.- Sealant band. Thickness 6 mm.
- 15.- Skirting wood board. 67 mm

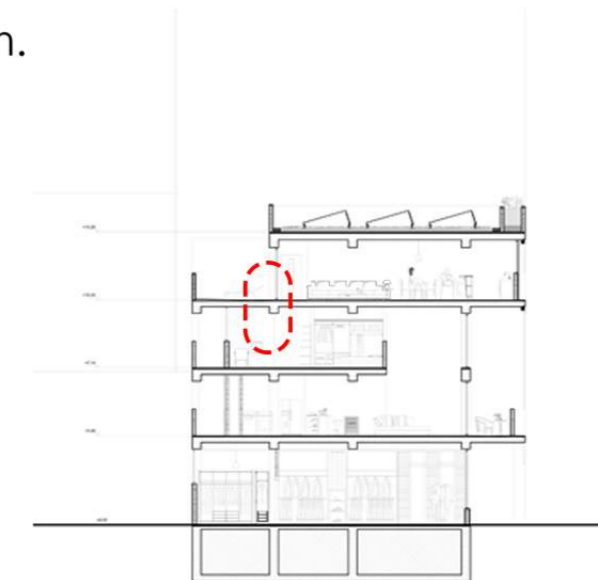

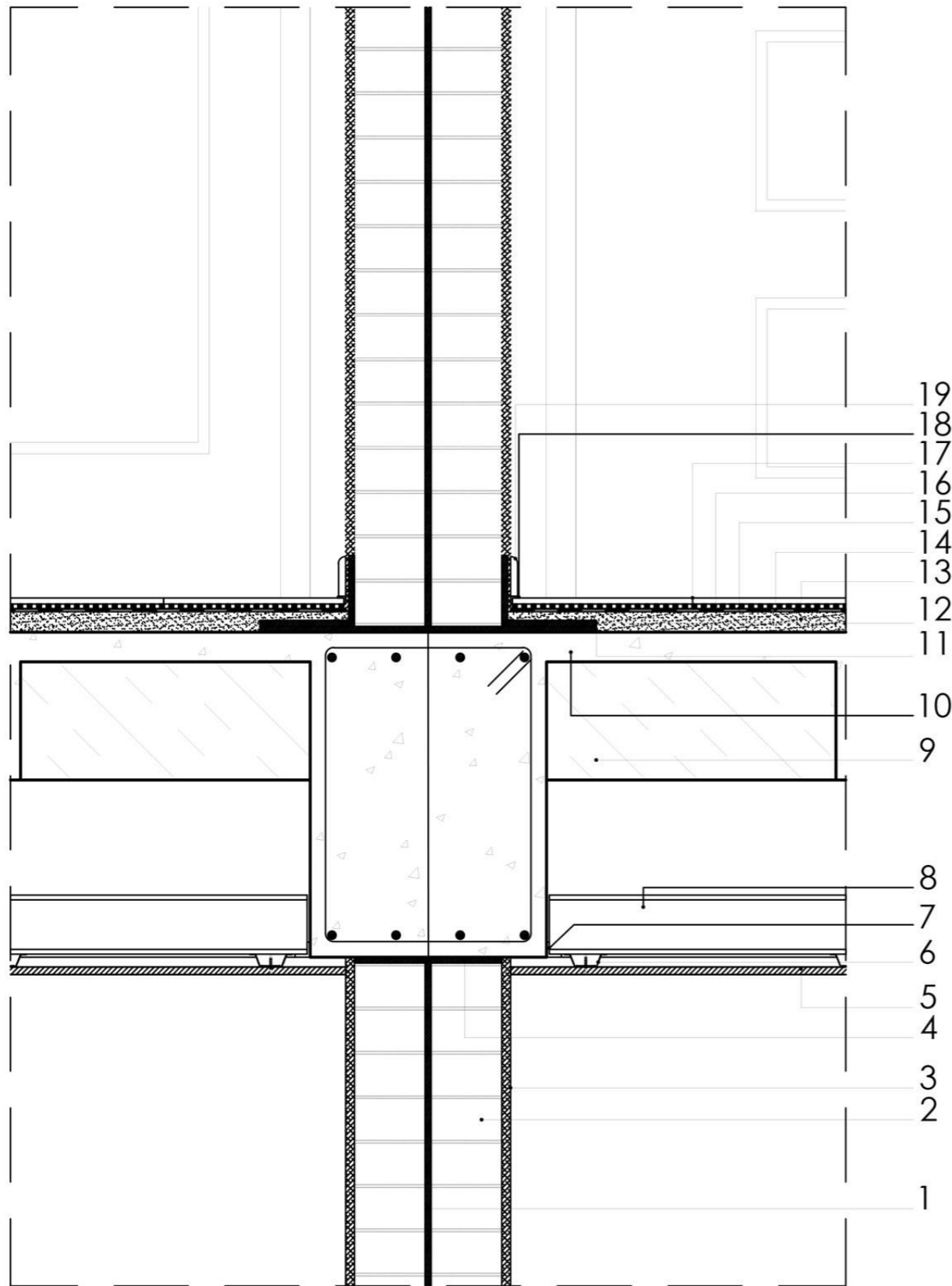

- 1.- Polyethylene acoustic insulating membrane in between walls. Thickness 10 mm.
- 2.- Cementitious block "Problock" (Thickness= 120 mm,  $\lambda = 0.145 \text{ w/mk}$ ,  $\rho = 1750 \text{ kg/m}^3$ ,  $c = 840 \text{ J/KgK}$ )
- 3.- Cementitious plaster (Thickness= 15 mm,  $\lambda = 0.9 \text{ w/mk}$ ,  $\rho = 1800 \text{ kg/m}^3$ ,  $c = 1000 \text{ J/KgK}$ )
- 4.- Polyethylene acoustic insulating membrane in the top of the wall. Thickness 10 mm.
- 5.- Gypsum board for false ceiling. Thickness 12 mm.
- 6.- Furring channel. Cal. 26.
- 7.- Aluminum clamping angle. 1"
- 8.- Loading channels. Cal. 26, 4"
- 9.- Expanded polystyrene for lightening the slab.
- 10.- Reinforced concrete slab 50 mm
- 11.- Polyethylene acoustic insulating membrane in the bottom of the wall. Thickness 10 mm.
- 12.- Polyethylene acoustic insulating membrane in between the floor and wall. Overlap 70 mm.
- 13.- Cementitious mortar. 30-40 mm
- 14.- Mapesonic CR. Sound proofing insulating sheet of rubber and cork. Thickness 4 mm.
- 15.- Ultrabond Eco V4 SP. Acrylic adhesive.
- 16.- Cementitious adhesive applied with notched trowel 8 x 8 mm
- 17.- Ceramic tile.
- 18.- Sealant band. Thickness 6 mm.
- 19.- Skirting wood board. 67 mm

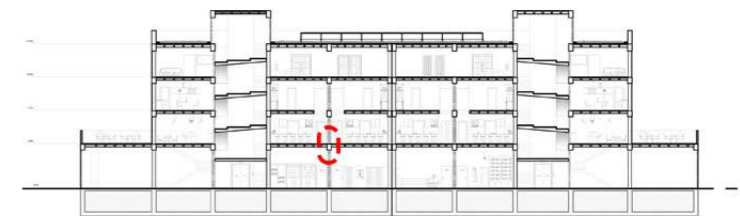

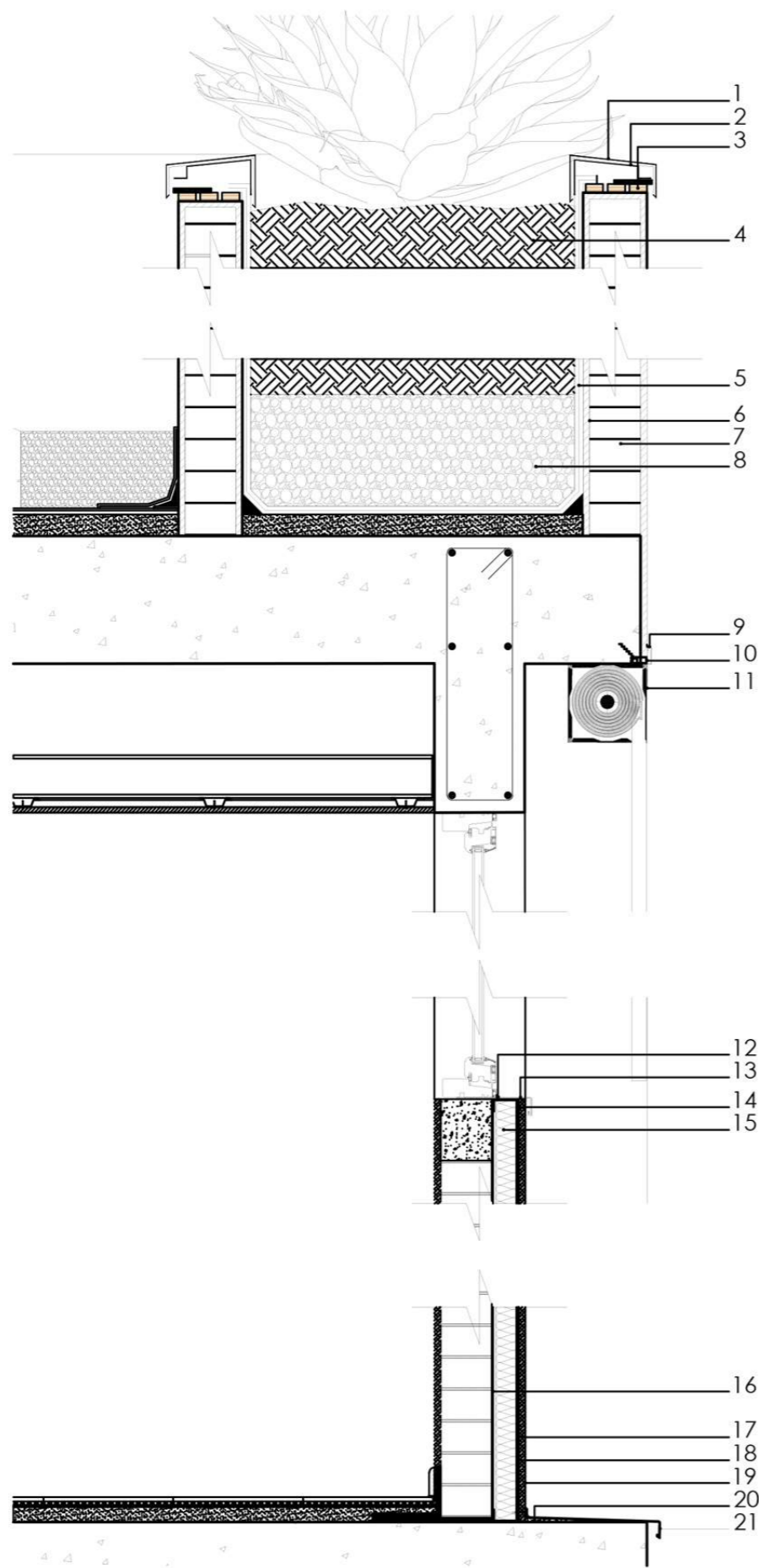

- 1.- Protective aluminium cap. Thickness 3 mm.
- 2.- Supportive element for steel cap.
- 3.- Wooden panels. Thickness 38 mm.
- 4.- Vegetal soil.
- 5.- Two layers of impermeable membrane.
- 6.- Cementitious plaster. Thickness 15 mm.
- 7.- Cementitious block "Problock".
- 8.- Drainage gravel layer.
- 9.- Capping.
- 10.- Subframe
- 11.- Aluminium case filled with poliurethane for curtain.
- 12.- Mapecil Ac. Acetic cross-linking waterproof silicon sealant. 5 mm.
- 13.- Rolled aluminium profile . Thickness 5 mm.
- 14.- Aluminium C profile.
- 15.- XPS Thickness 50 mm.
- 16.- Adhesive mortar.
- 17.- Adhesive mortar for reinforcement mesh embedding.
- 18.- Reinforcement glass fiber mesh.
- 19.- Rendering mortar. Mineral silicate based silicon based or acrylic.
- 20.- Rendering mortar. Mineral silicate based silicon based or acrylic to give the pendant to the aluminium profile.
- 20.- Rolled aluminium profile. Thickness 3 mm.

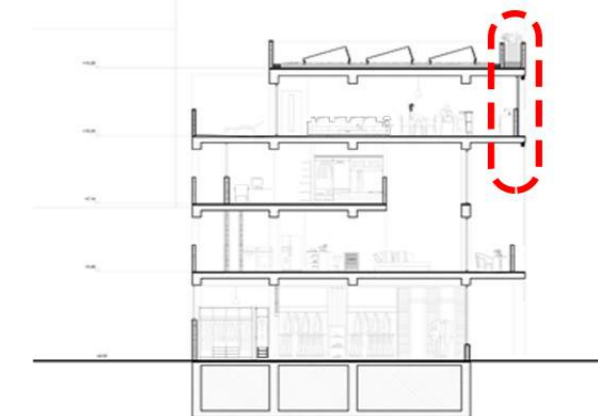

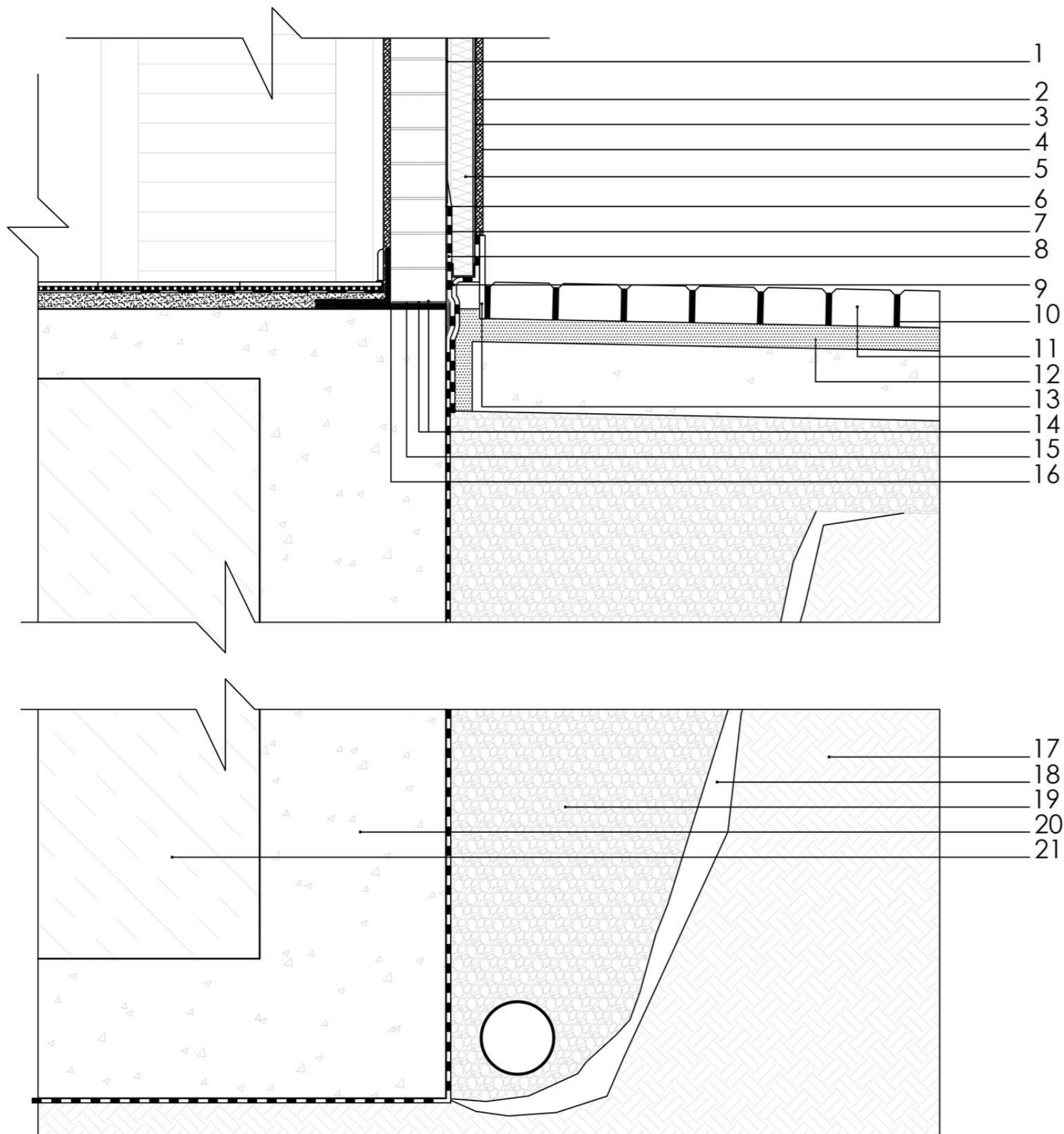

- 1.- Adhesive mortar.
- 2.- Adhesive mortar for reinforcement mesh embedding.
- 3.- Reinforcement glass fiber mesh.
- 4.- Rendering mortar. Mineral silicate based silicon based or acrylic.
- 5.- XPS Thickness 50 mm.
- 6.- Remmers Aida Kiesol Prime®. Water repelling silica acid composed liquid. Apply diluted 1:1 with water.
- 7.- 1 Coat of Remmers Sulfatex Grout®. Sulphate resistant cementitious layer.
- 8.- Styrbase stick®. Bituminous waterproofing membrane. 10 mm.
- 9.- Styrbase stick®. 10 mm.
- 10.- Grout.
- 11.- Precast concrete cobble. 80 mm.
- 12.- Layer of sand. 50 mm.
- 13.- Skirting cementitious board.
- 14.- 2 Coat of Remmers Sulfatex Grout®.
- 15.- Remmers Aida Kiesol Prime®.
- 16.- Acoustic insulating membrane.
- 17.- Natural soil.
- 18.- Lateral screen. Geo-textile.
- 19.- Granular base.
- 20.- Reinforced concrete foundation.
- 21.- Expanded polystyrene.

