

AGOPUNTURA URBANA

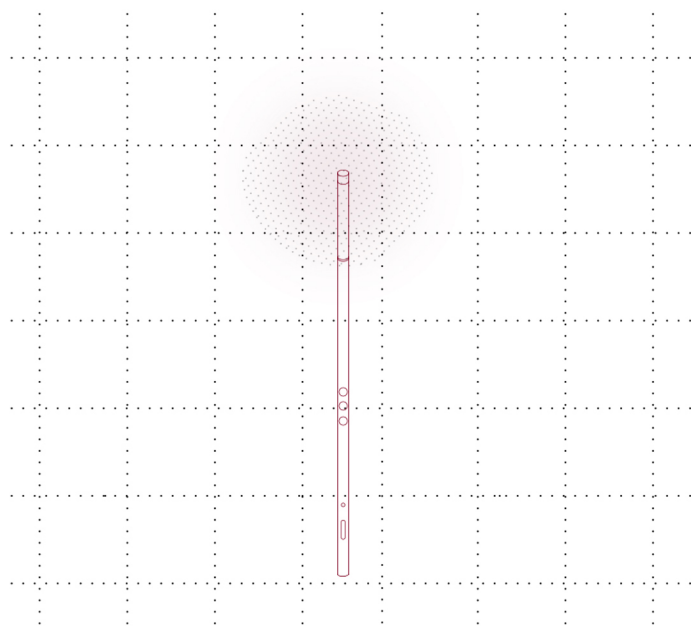

PALO CIRCOLARE IN ACCIAIO INOX PER L'ILLUMINAZIONE DI VIALI PEDONALI (H=4.50m , Ø 10 cm)



LAMPADA TIPO *BLENDED LIGHT* TIPO 100-160 W

DISPENSATORE DI CALORE E VAPORE FRESCO PER PAUSE CONFORTEVOLI DURANTE L'INVERNO E L'ESTATE

EMETTITORE DI SUONO

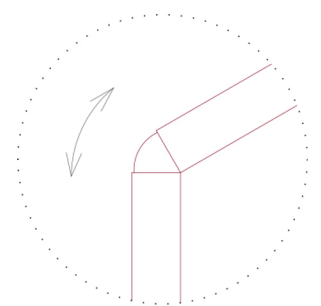

ESTREMITA' ROTEANTE

DISPLAY QR CODE PER ACCESSO A INFORMAZIONI

PRESA PER ENERGIA ELETTRICA

GENERATORE WI FI

FORO PER AURICOLARI

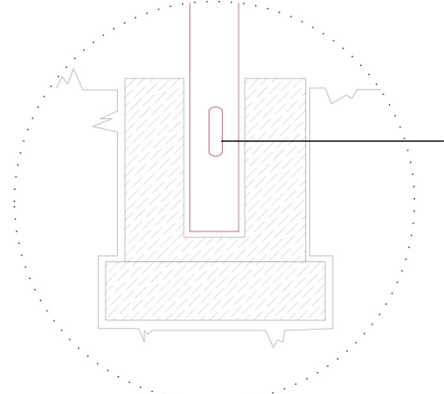
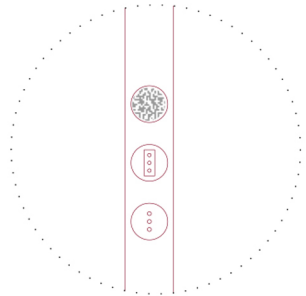
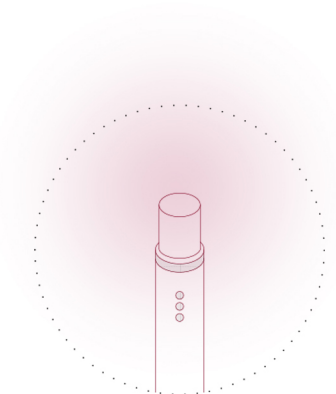

ASOLA ENTRATA CAVI

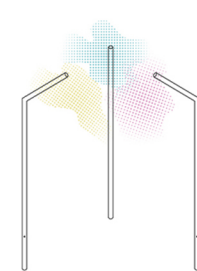

"lampioni robot"

"Luci in movimento"

POSSIBILI USI

"pause rinfrescanti"

Possibilità di allestire veicoli per lo street food

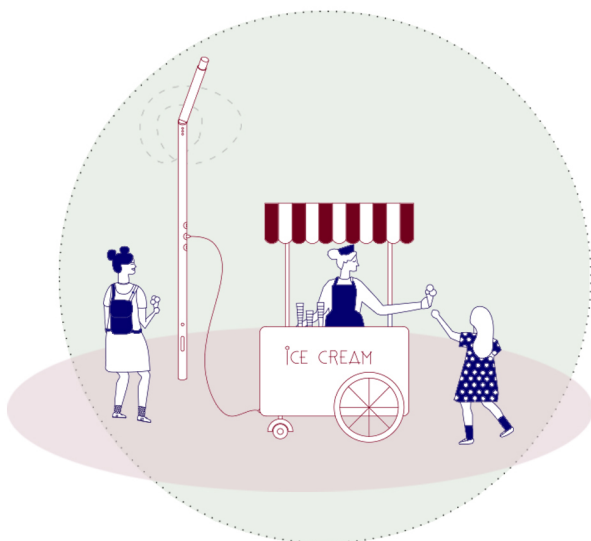

"il riparo"

Dispensatore di calore per pause confortevoli durante i mesi invernali



"lo svago"

Ascoltare la musica al chiaro di luna

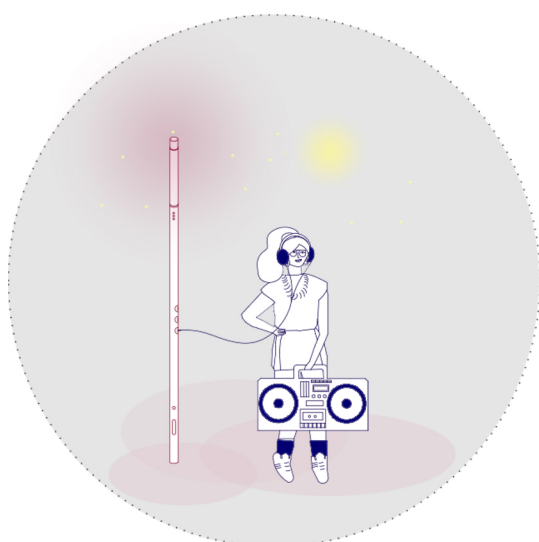

"quotidianità"

Prese per la corrente elettrica permettono il caricamento di smartpone, tablet, PC

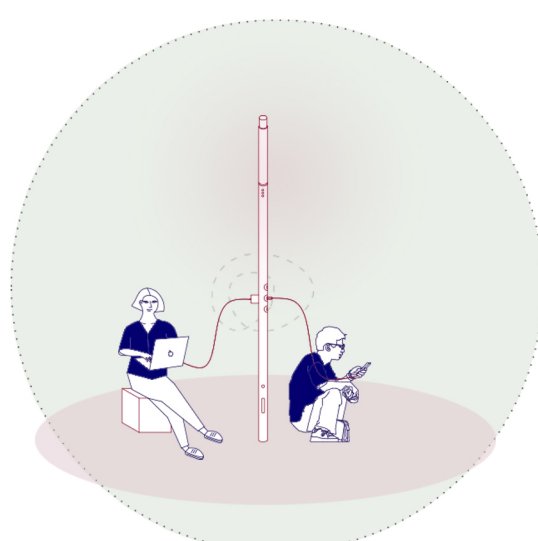

BOSCO MUSICALE

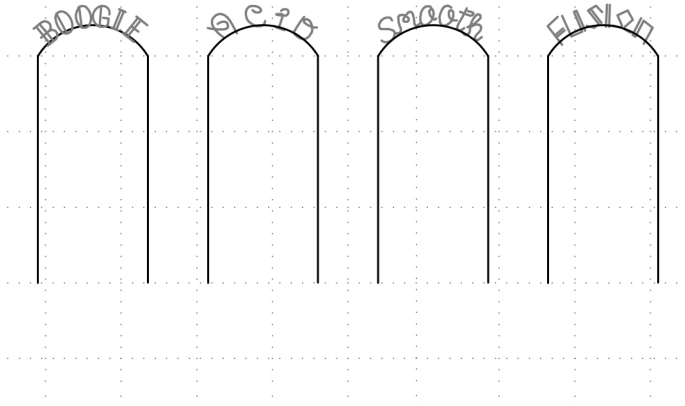

Acid jazz

Bebop

Cool Jazz

Free Jazz

Fusion

Hard Bop

Improvisation Jazz

Jazz rap

Jazz-funk

Jazz samba

Latin jazz

Post-bop

Punk Jazz

Scat

Shidaigu

Smooth Jazz

Soul Jazz

Swing



TUBO ZINCATO A CALDO PER SEGNALETICA STRADALE
DIAMETRO 48 mm

SCRITTA SAGOMATA NEON
ALTEZZA 50 cm

ASCOLTARE UNA CANZONE JAZZ AL CHIARO DI NEON,
RILASSARSI SUL MOLO O IMPROVVISARE UN BALLO

DISPOSITIVI COMPLEMENTARI



SEDUTA A SDRAIO



CHILL PILLS



PUFF GONFIABILE

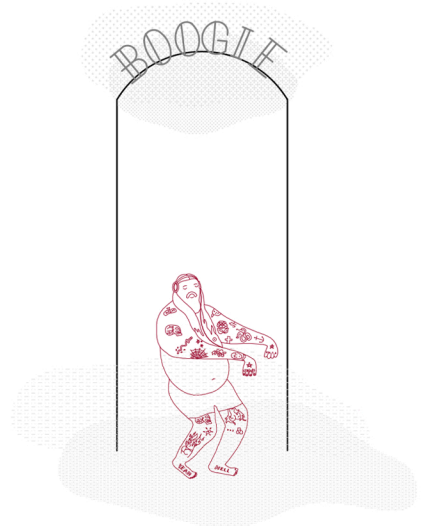

ATMOSFERA DIURNA



ATMOSFERA NOTTURNA

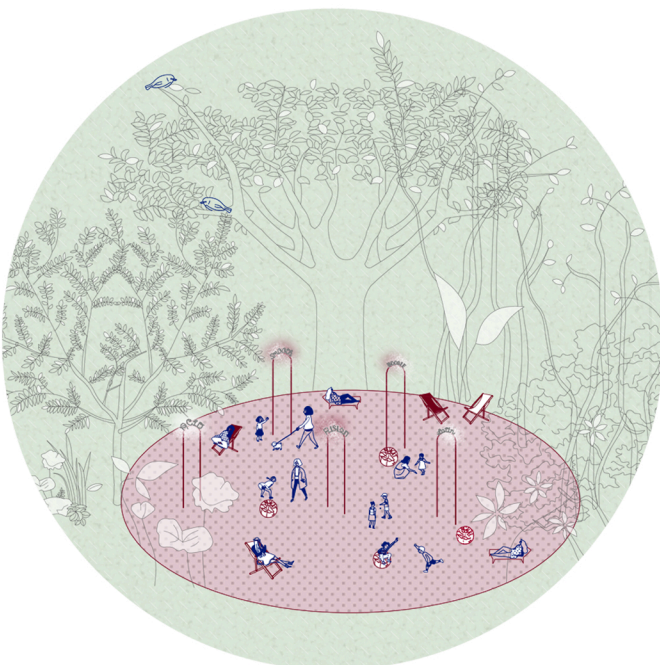

CORPO DI LUCE

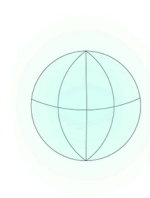
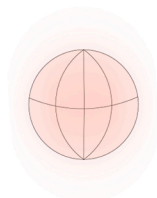
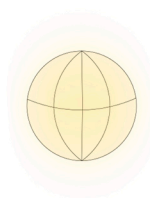
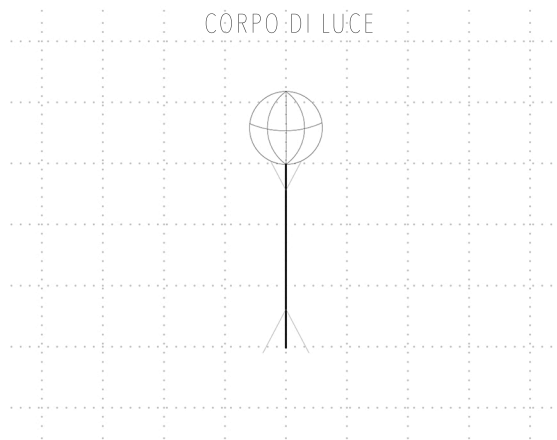

Nelle calde sere d'estate che colore sceglieresti?

In un pomeriggio uggioso?

Non ti piacerebbe fare un pic nic al chiaro di luna?

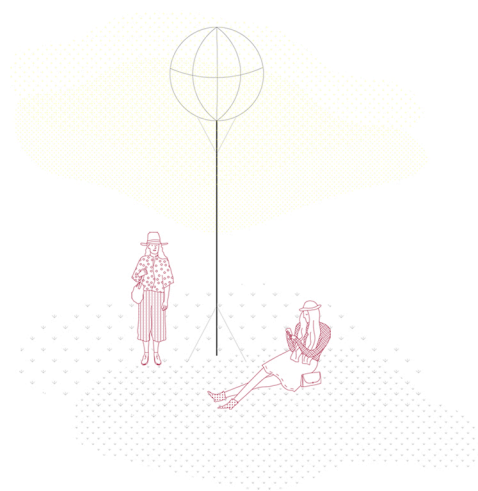

BAUSTELLE- UN ROMANTICO A MILANO

UNA GIUNGLA DI GIOCHI

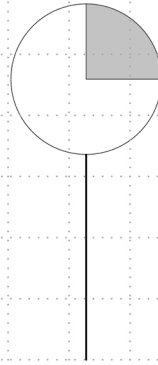

PIATTAFORME ATTEZZATE CON GIOCHI SONORI, TATTILI,
TRASFORMABILI NELLE STAGIONI INVERNALI IN PISTE DI PATTINAGGIO
O ARENE PER PUPAZZI DI NEVE

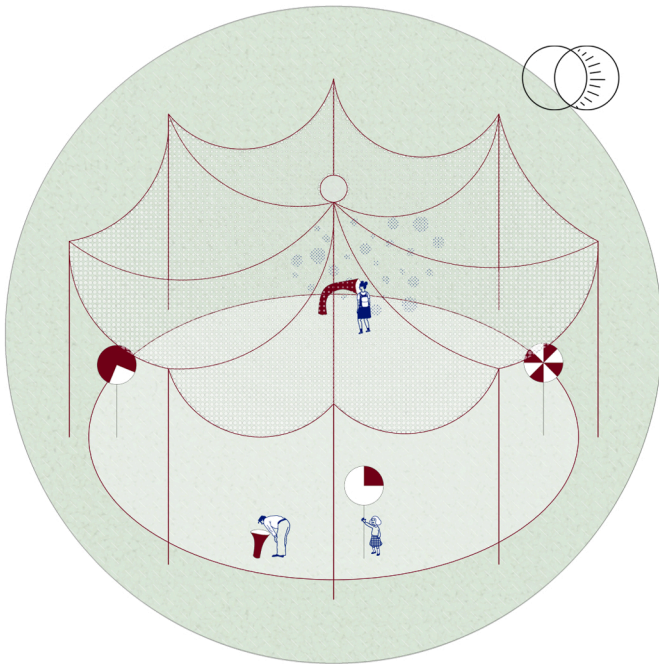

GIOCHI DI PRIMAVERA

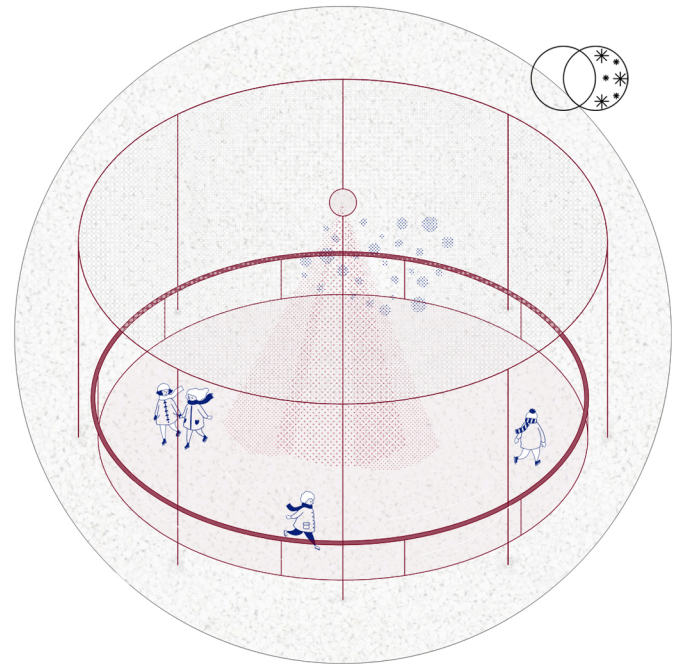

PATTINAGGIO SUL GHIACCIO

GEOGRAFI CONTEMPORANEI

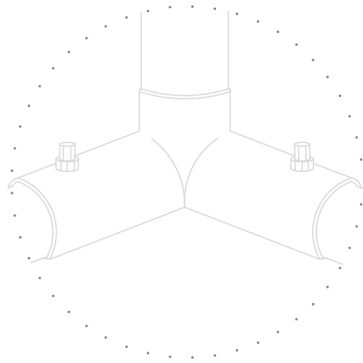
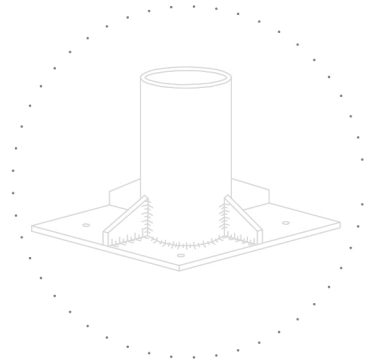
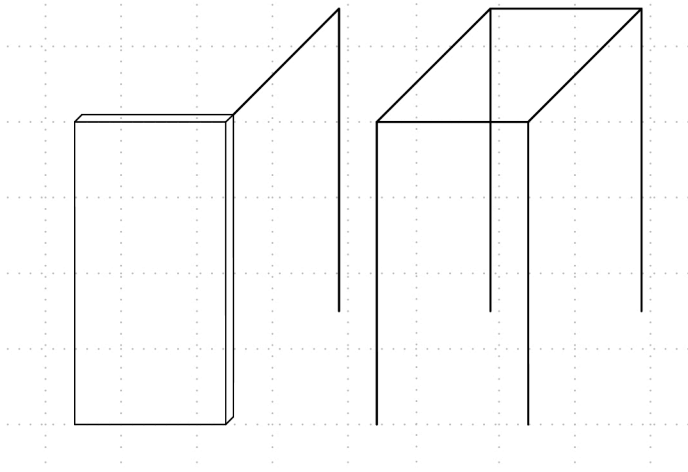

DISPOSITIVI COMPLEMENTARI

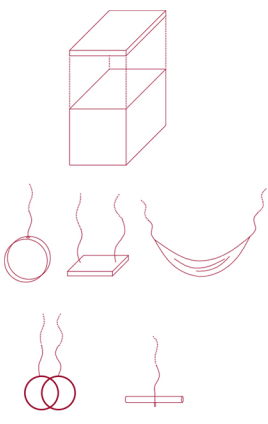

BANCARELLA-TAVOLO ASSEMBLABILE

CHILL PILLS

TRAINING PILLS

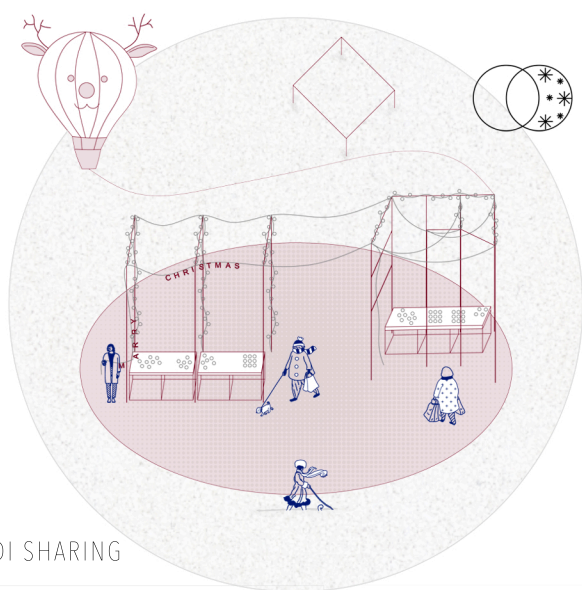
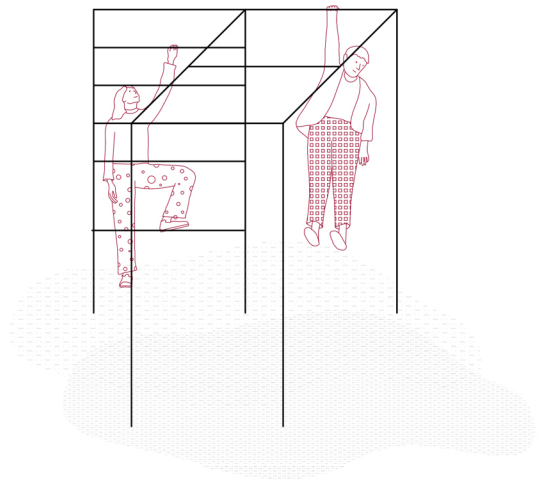

MERCATINI O EVENTI DI SHARING

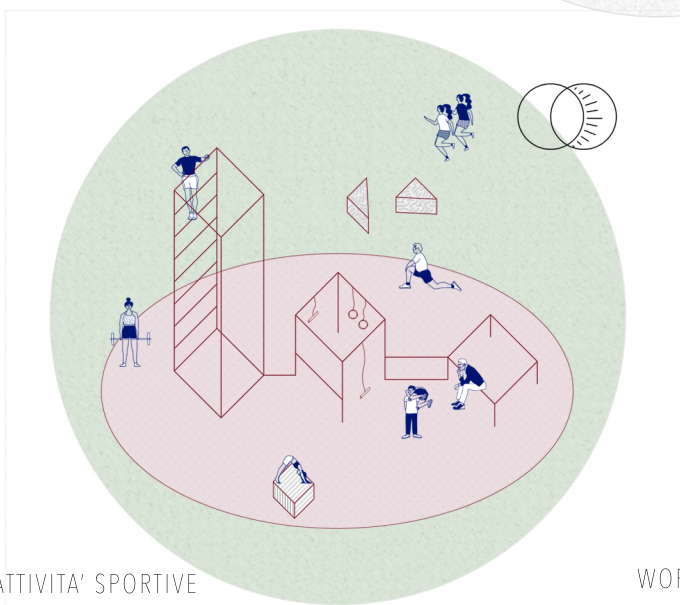

ATTIVITA' SPORTIVE

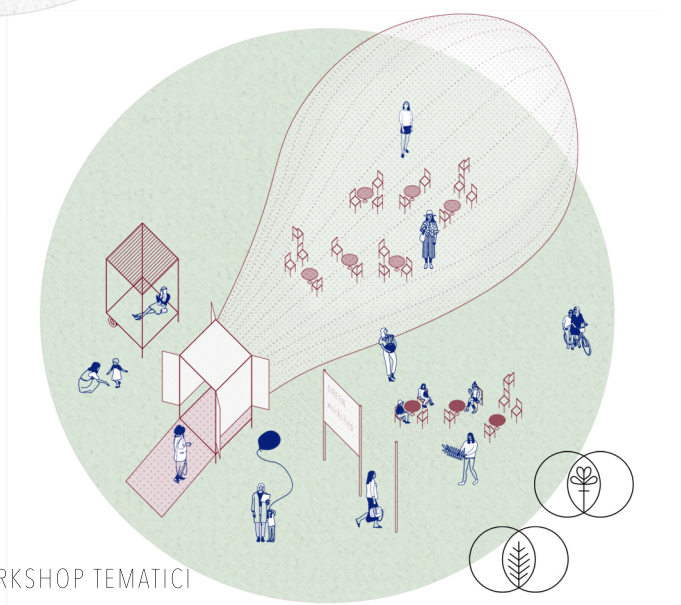

WORKSHOP TEMATICI