

Designing for Gen Z: A New Collective Space within the Historical Context of Lazzaretto, Milan

Site Analysis



Greenery Analysis



Functional Analysis



Urban Network Analysis

1:5000



Site Axonometry

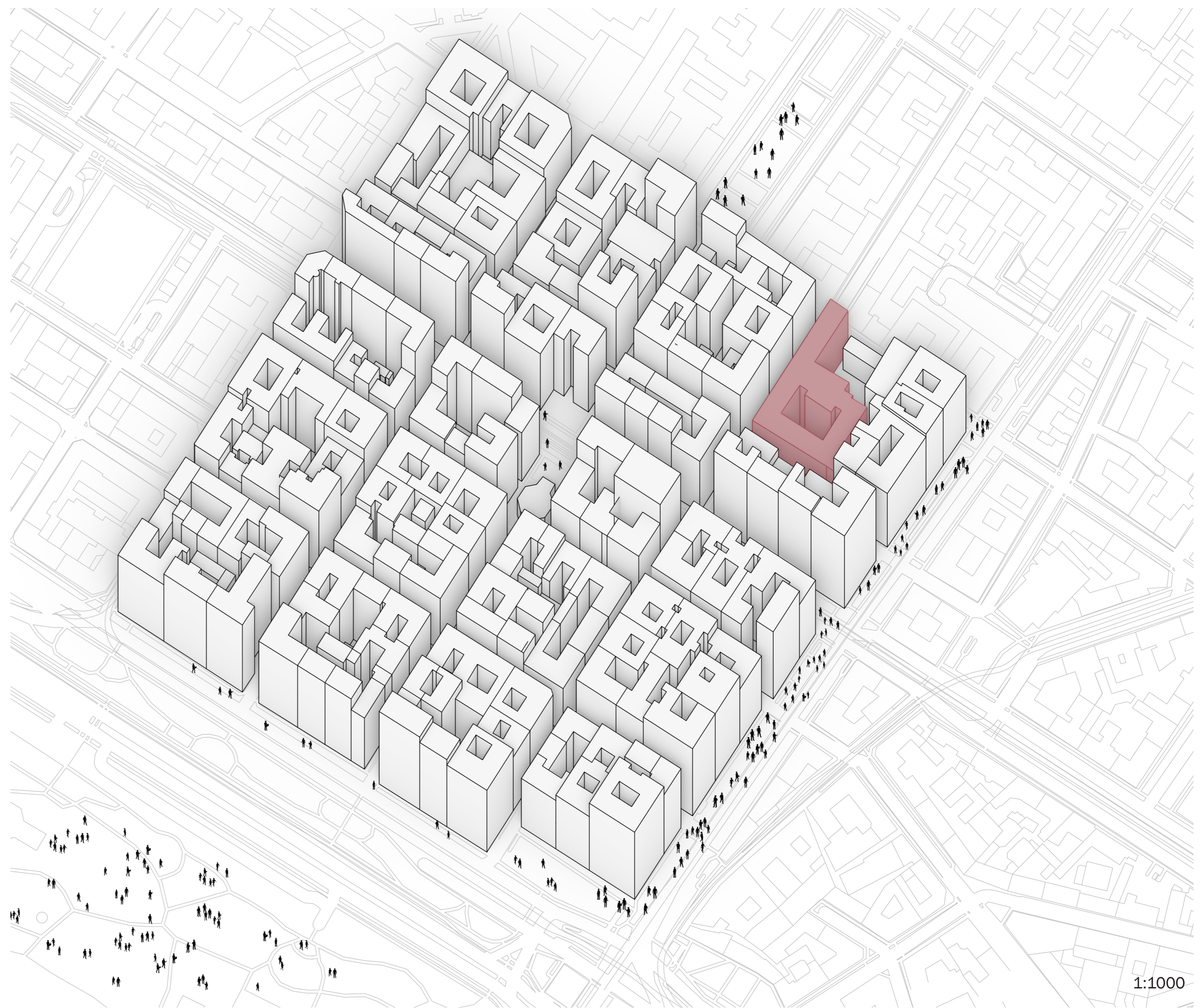

1:1000

Masterplan



1:500



Existing Building Axonometry

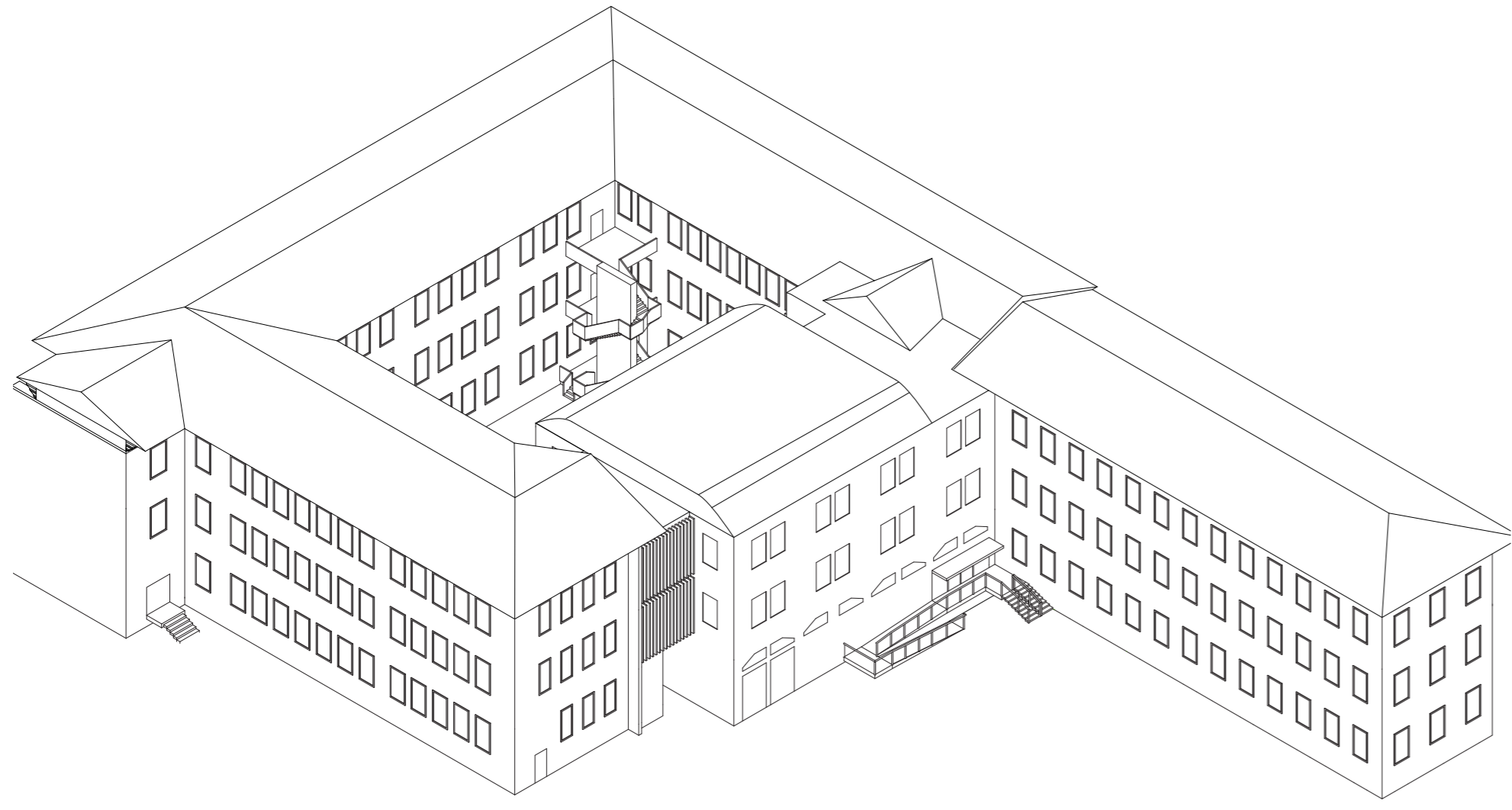

Existing Building Section

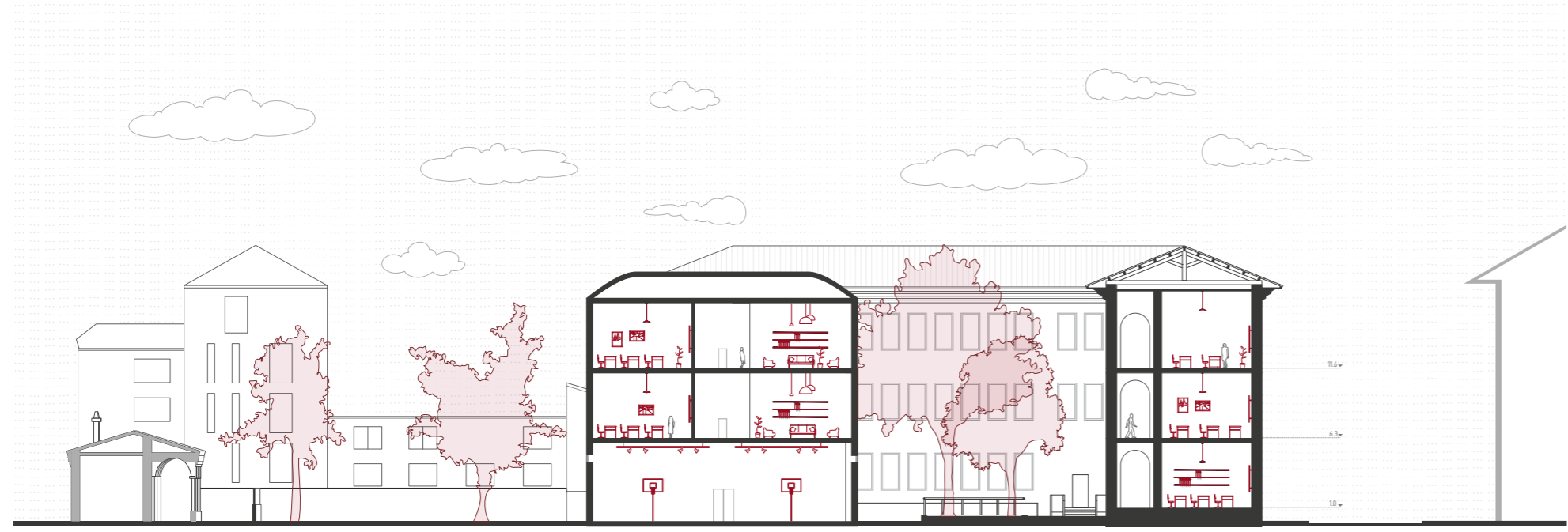

1:500

Building Evolution

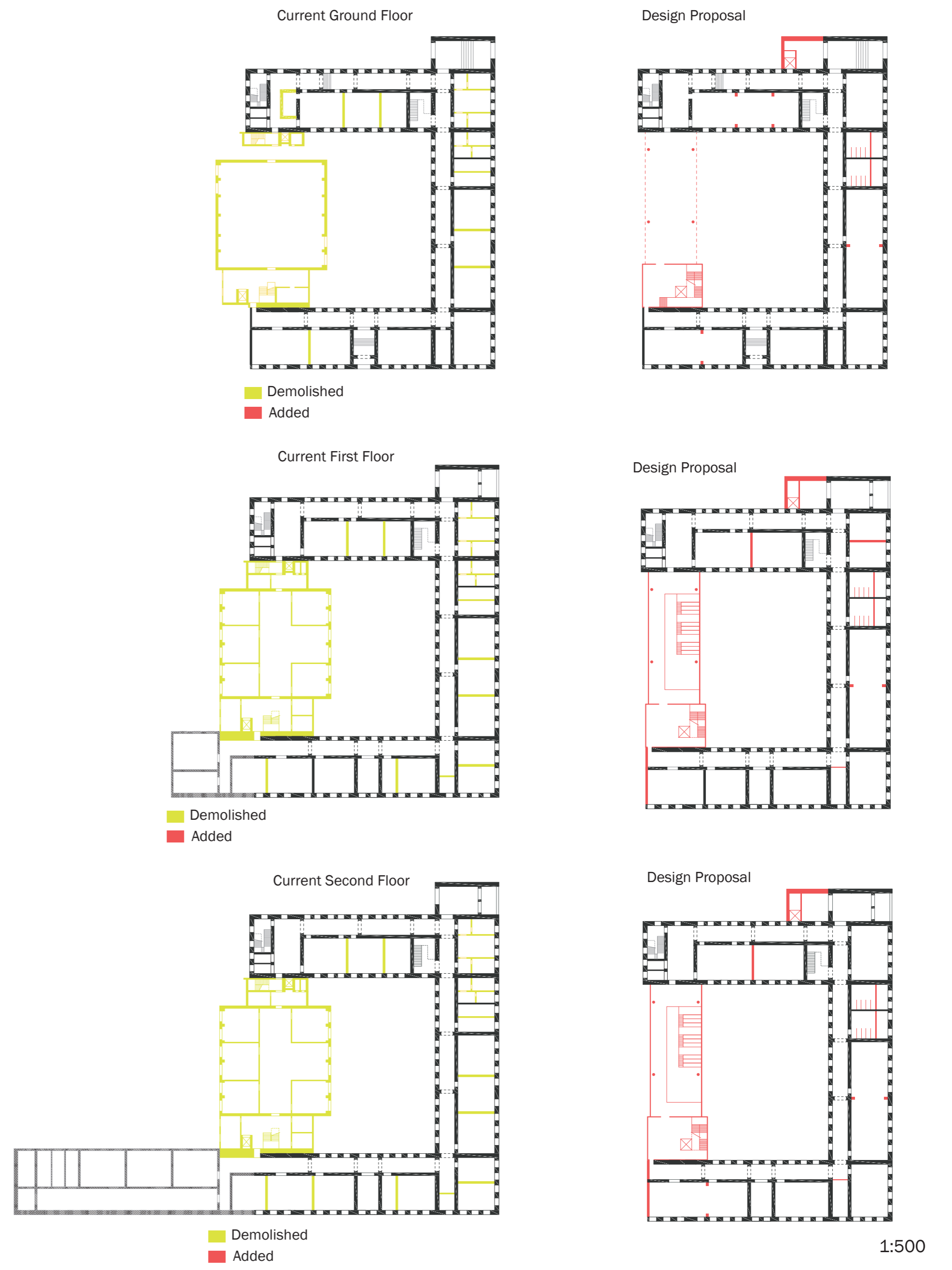

Building Axonometry

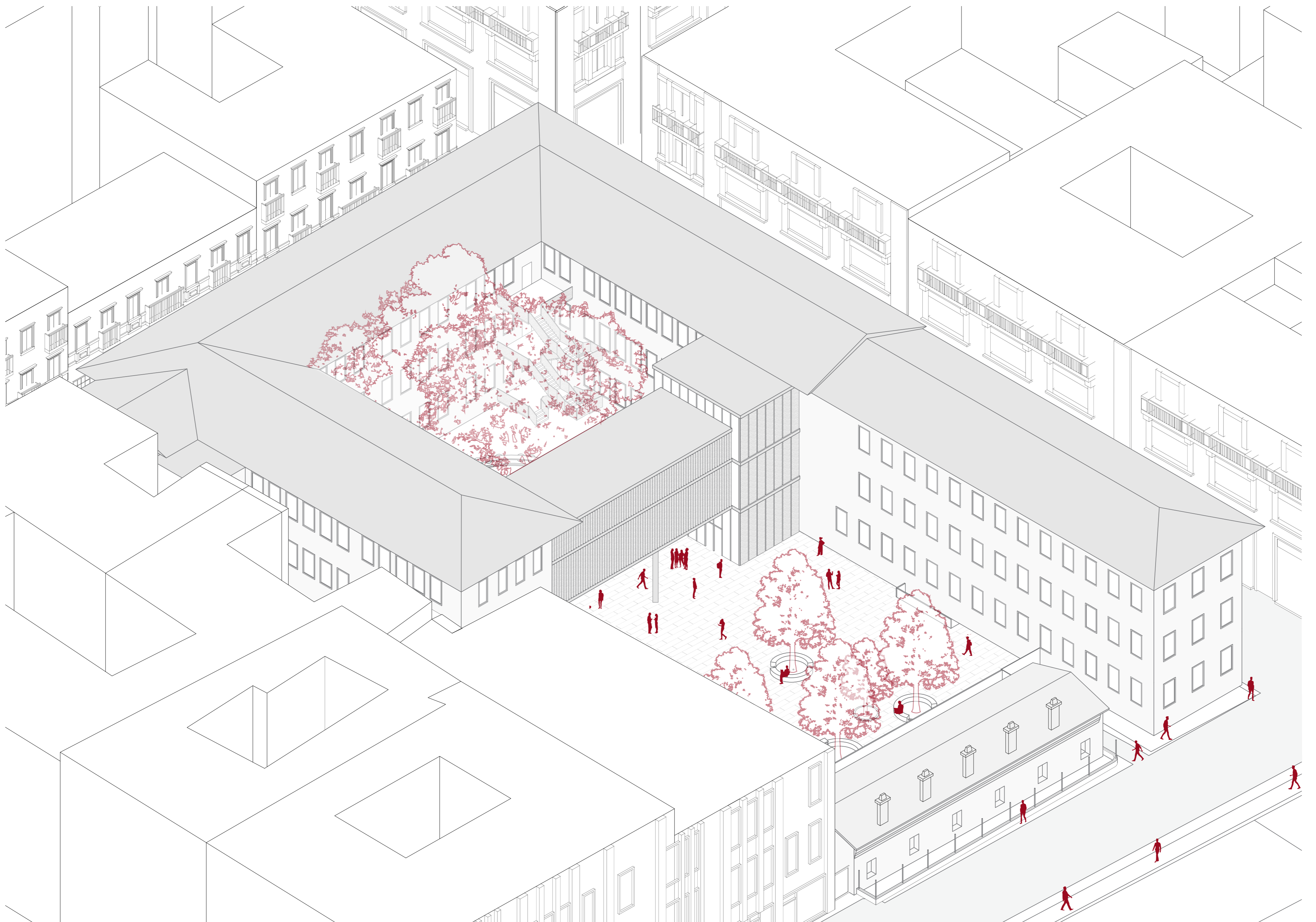

Floor Plans

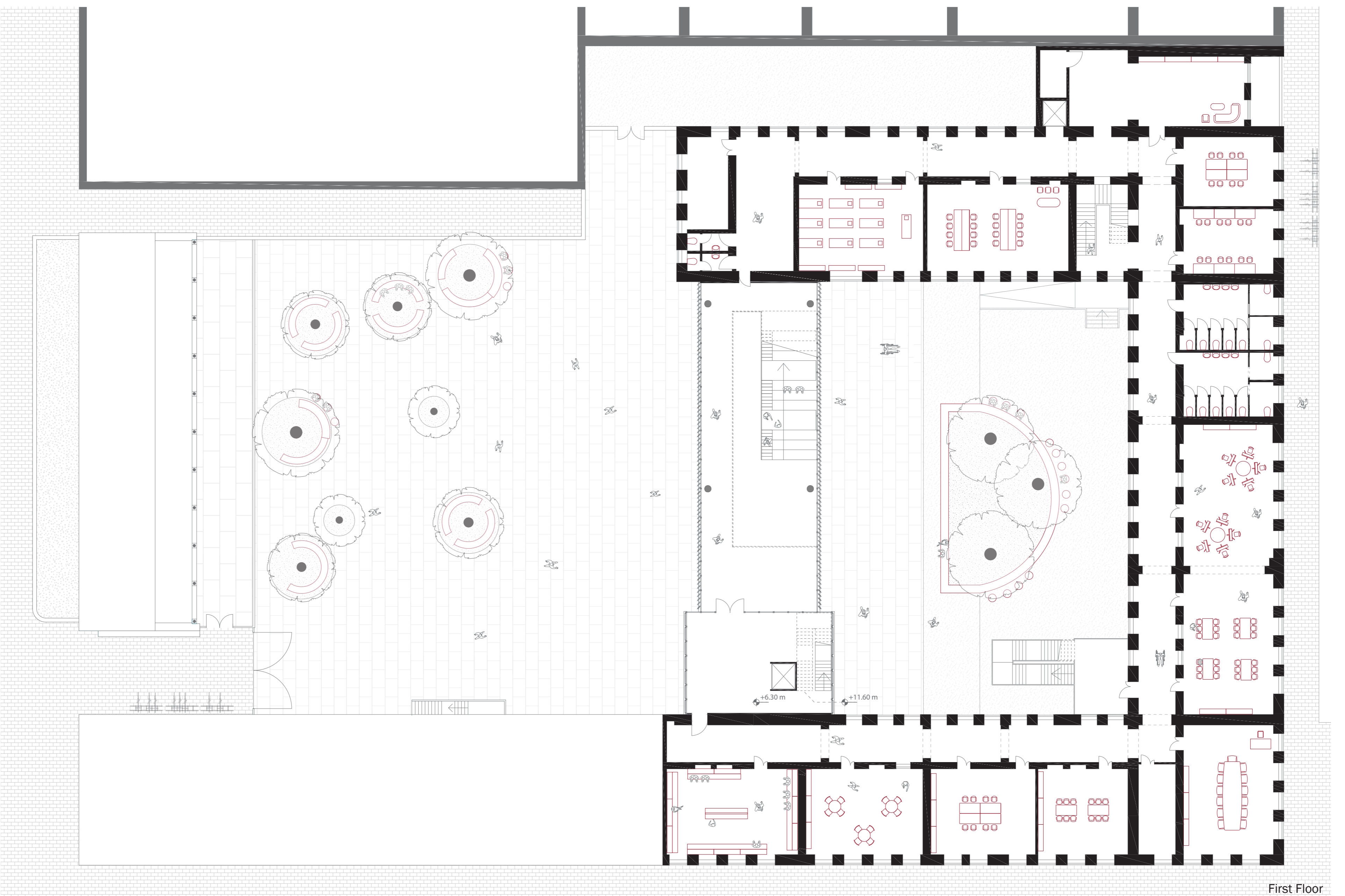
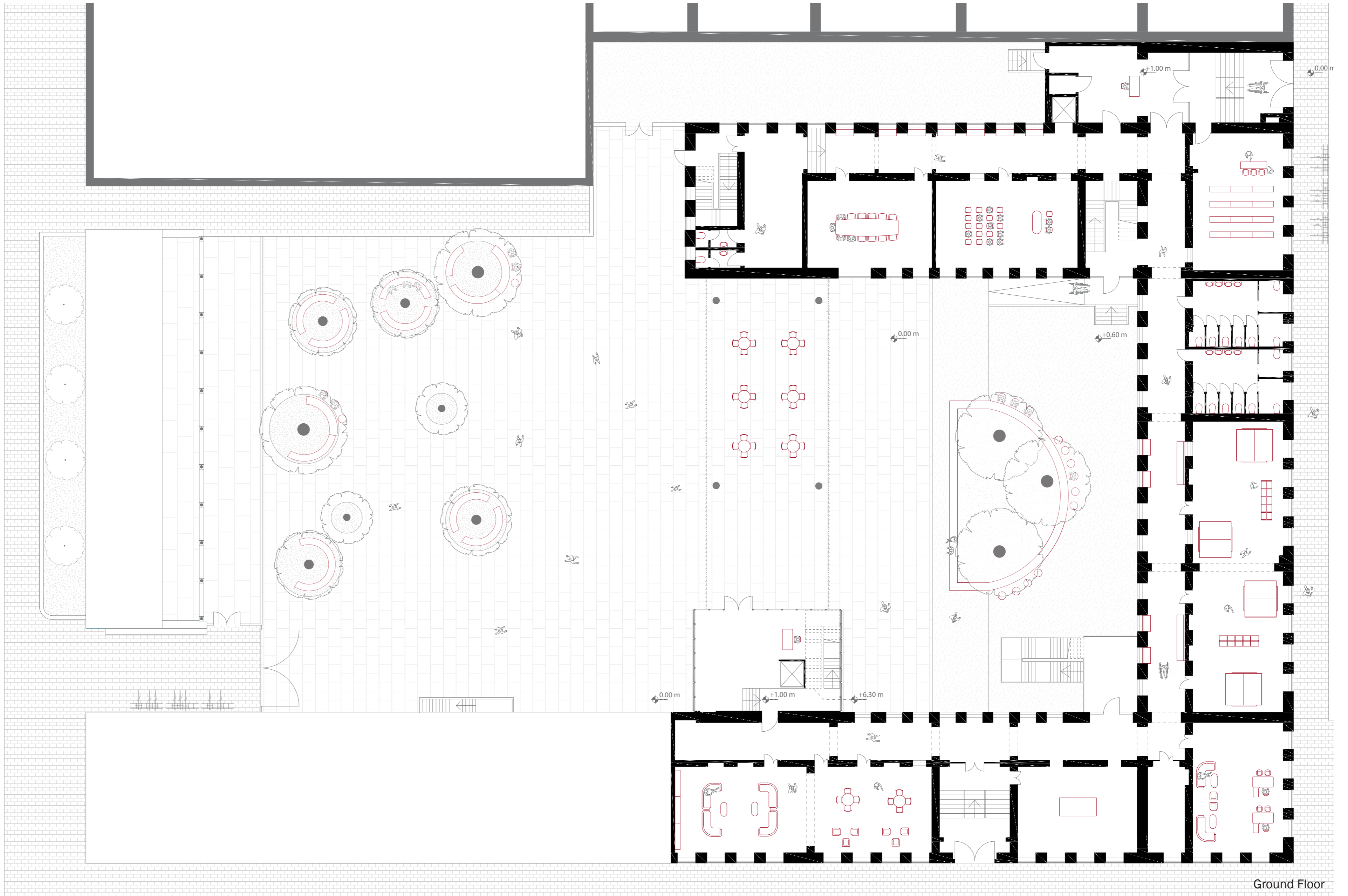

1:200



Authors: Deren Selcuk, Tamara Chamsi Bacha, Zeynep Kitapci

A.Y. 2024-2025
Supervisor: Professor Elena Montanari
M.Sc. Architecture - Built Environment Interiors
School of Architecture, Urban Planning, and Construction Engineering



POLITECNICO
MILANO 1863

Floor Plans

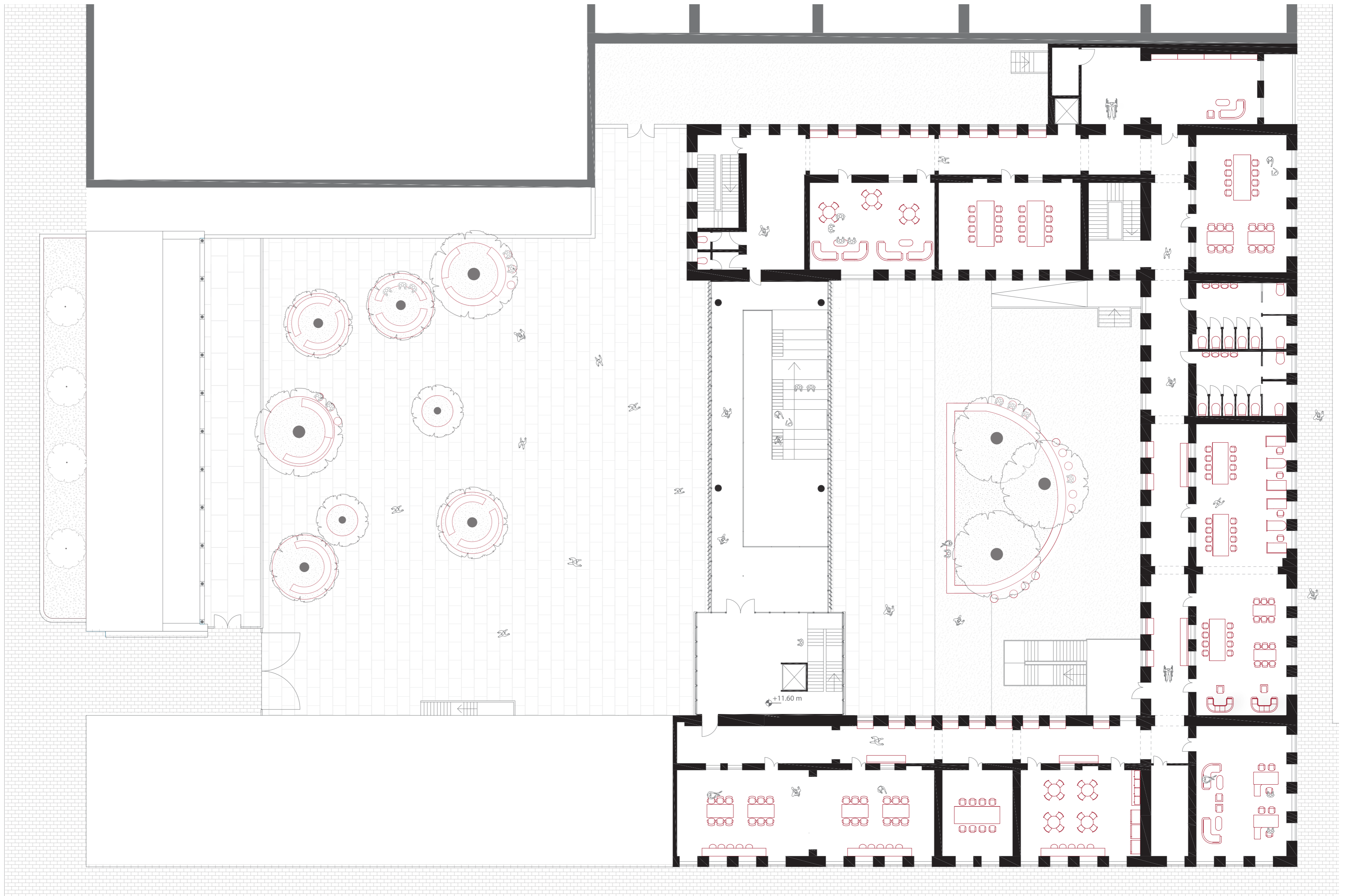

Second Floor
1:200



Program Axonometry

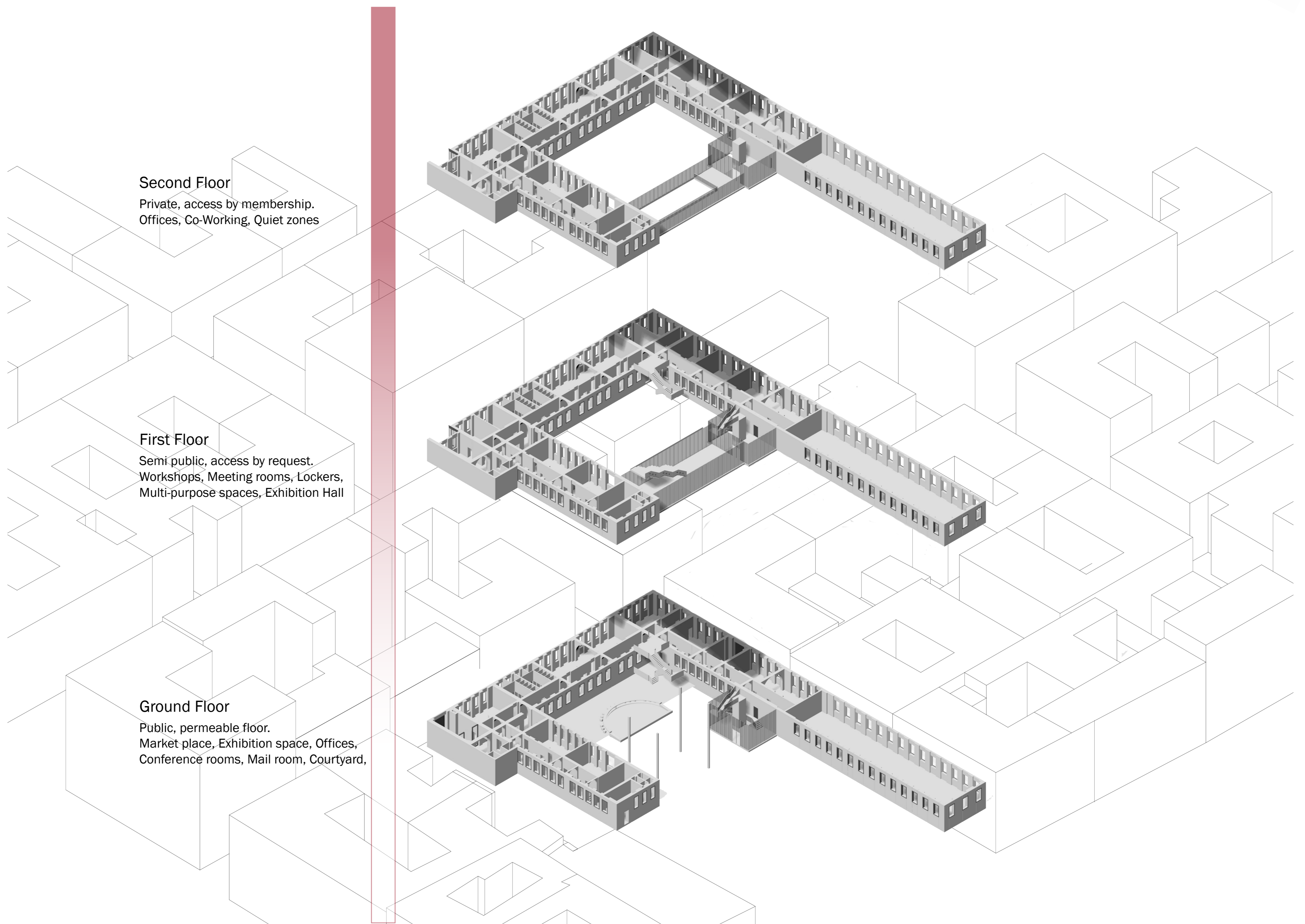

Second Floor
Private, access by membership.
Offices, Co-Working, Quiet zones

First Floor
Semi public, access by request.
Workshops, Meeting rooms, Lockers,
Multi-purpose spaces, Exhibition Hall

Ground Floor
Public, permeable floor.
Market place, Exhibition space, Offices,
Conference rooms, Mail room, Courtyard,

Sections & Elevations

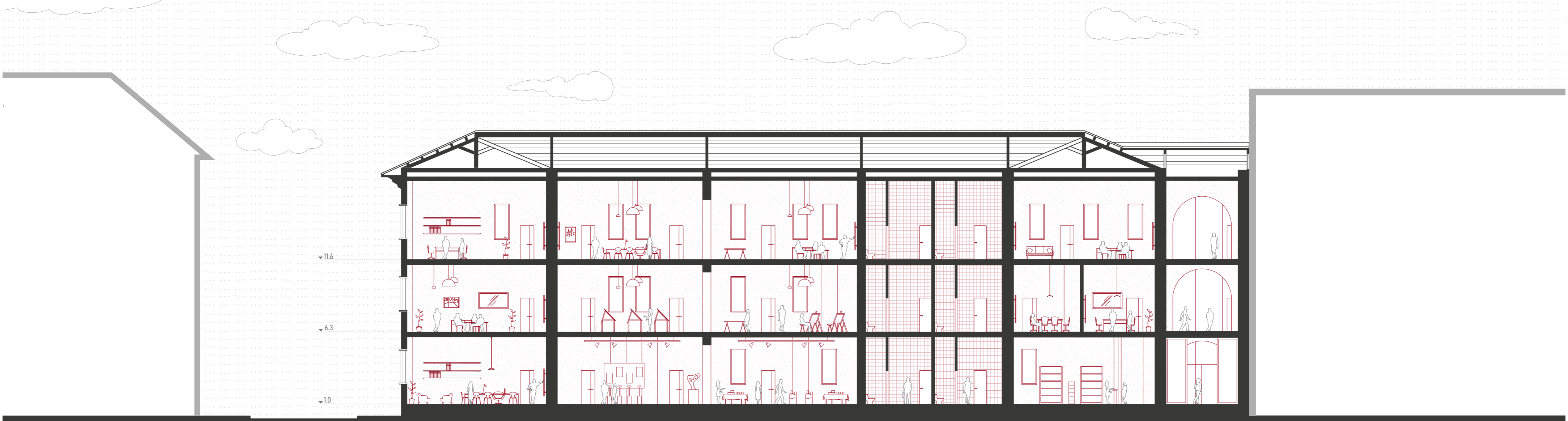
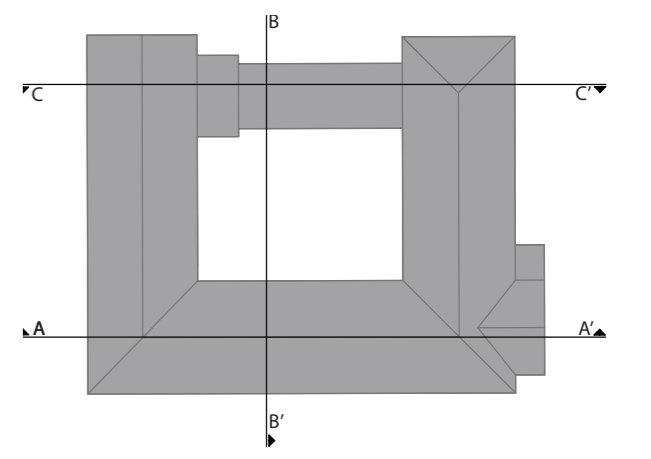

Section A-A'

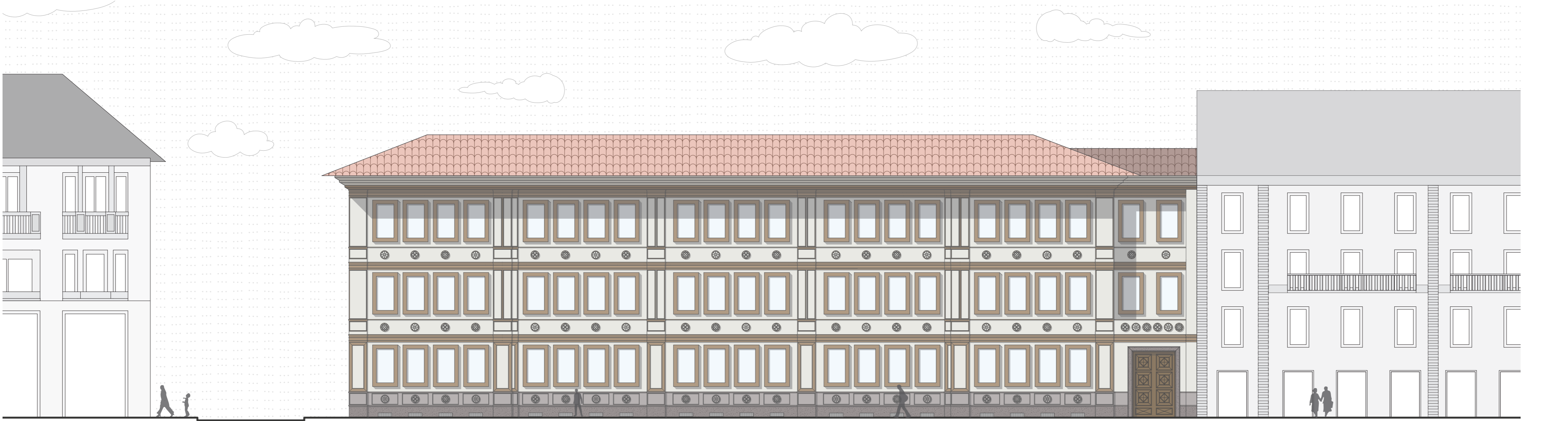

South-West Elevation

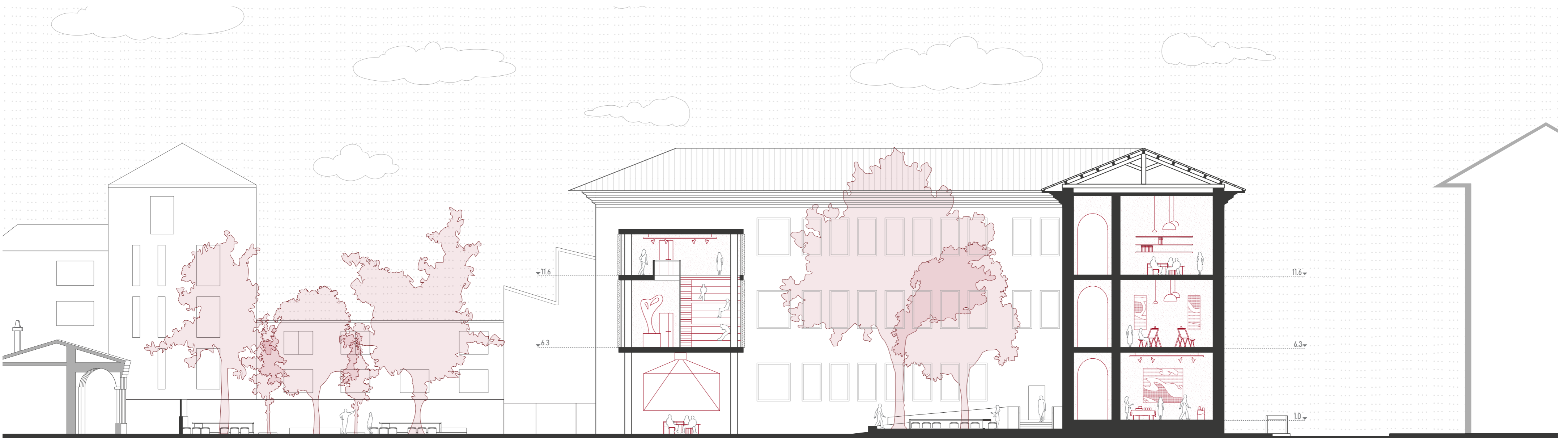

Section B-B'



North-West Elevation

1:200

Authors: Deren Selcuk, Tamara Chamsi Bacha, Zeynep Kitapci

A.Y. 2024-2025
Supervisor: Professor Elena Montanari
M.Sc. Architecture - Built Environment Interiors
School of Architecture, Urban Planning, and Construction Engineering

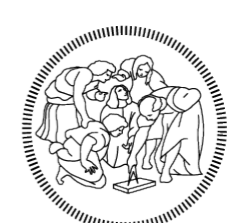

POLITECNICO
MILANO 1863

Sections & Elevations

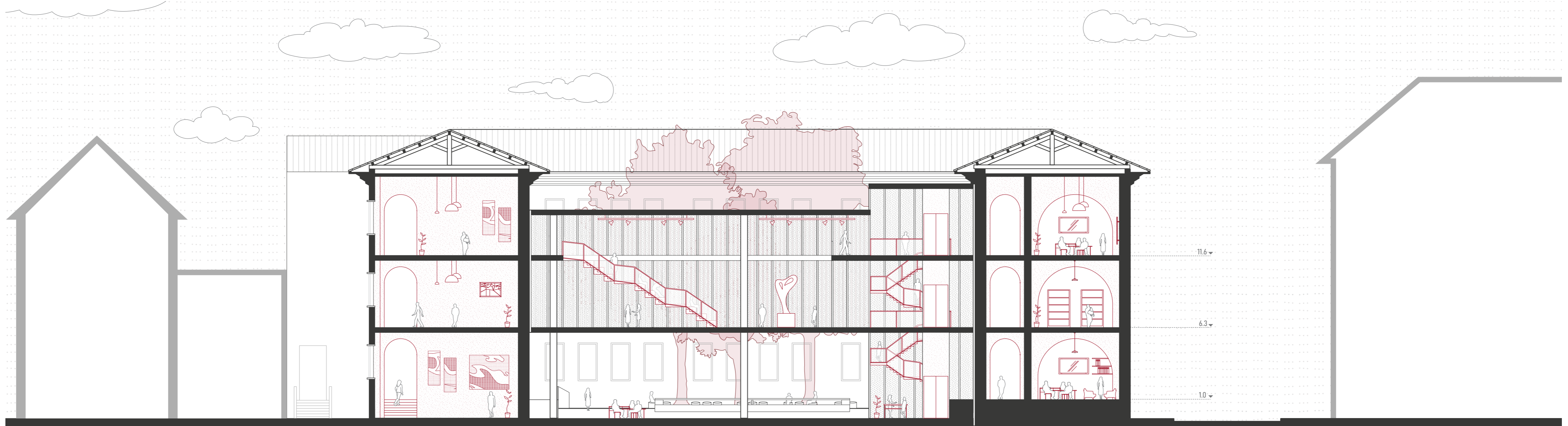

Section C-C'

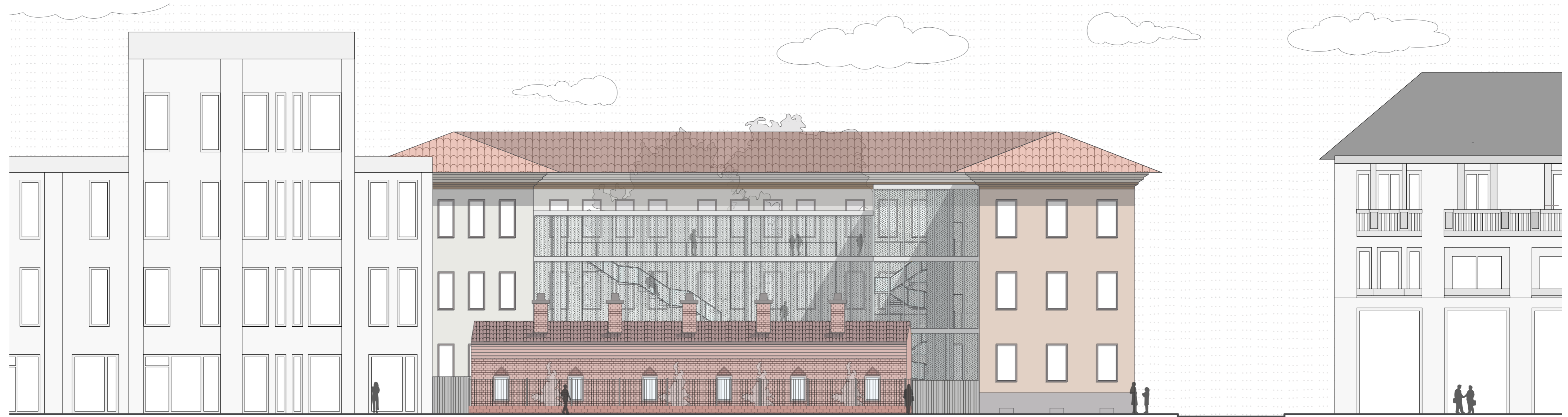

North-East Elevation

1:200

Bridge Facade

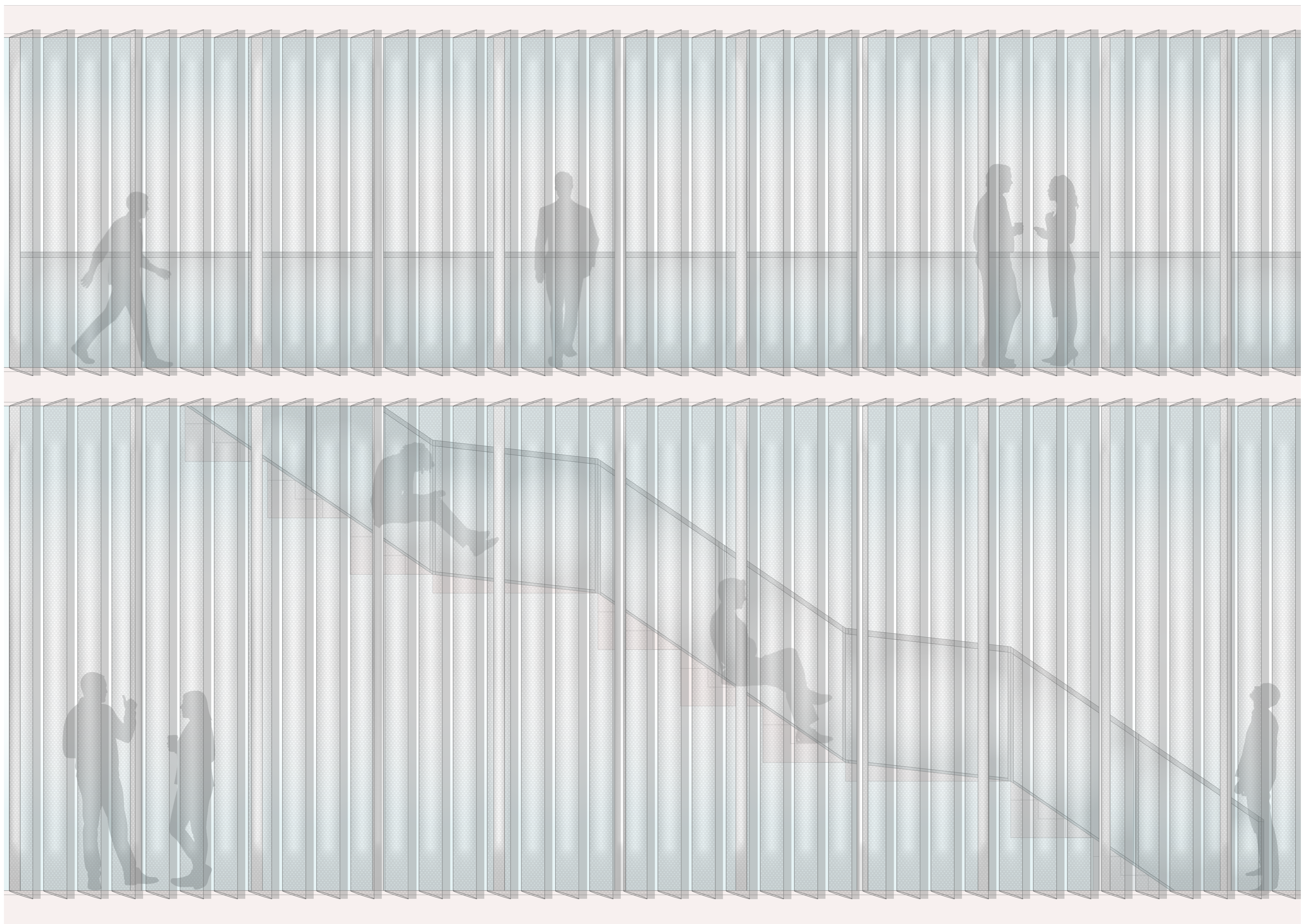

1:20

Authors: Deren Selcuk, Tamara Chamsi Bacha, Zeynep Kitapci

A.Y. 2024-2025
Supervisor: Professor Elena Montanari
M.Sc. Architecture - Built Environment Interiors
School of Architecture, Urban Planning, and Construction Engineering

Close-up Plans
Ground floor

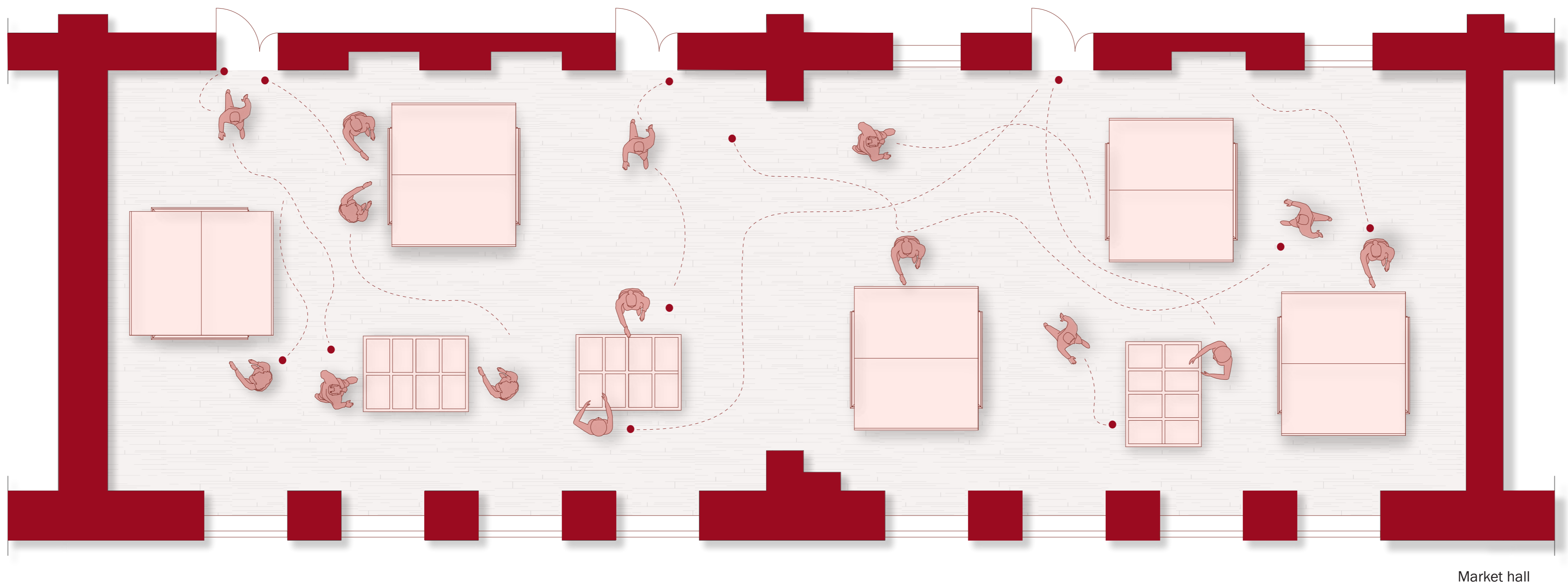

Market hall

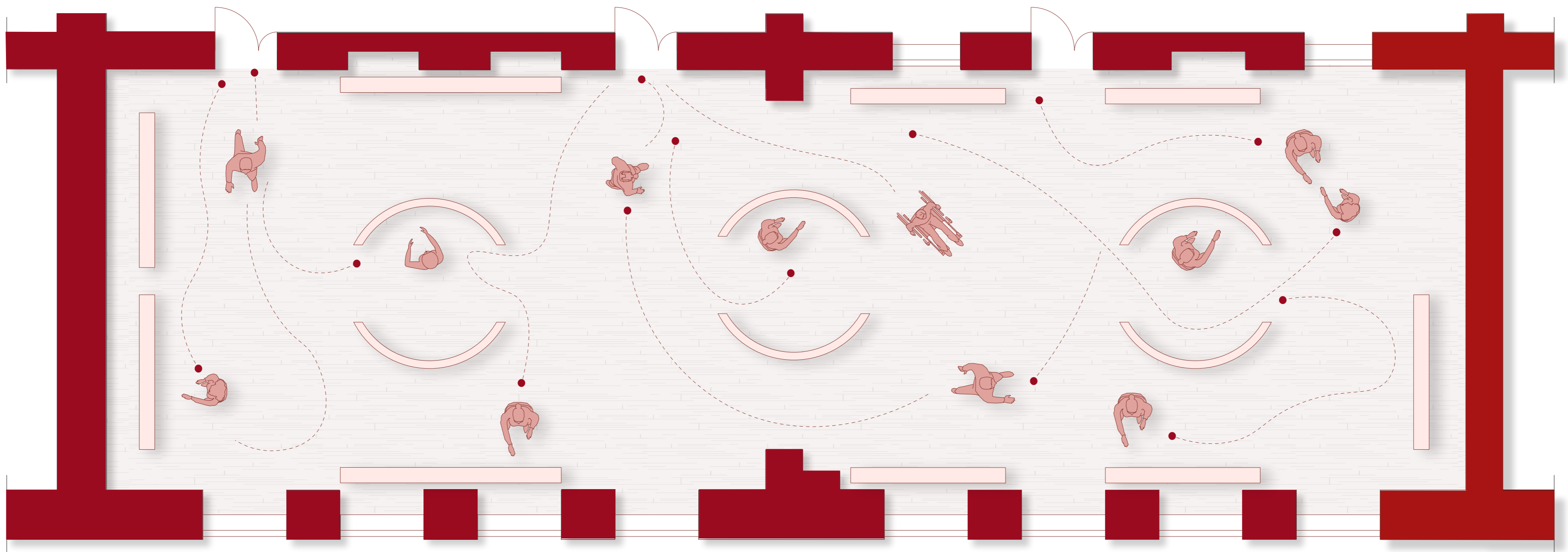

Exhibition Hall

Close-up Sections

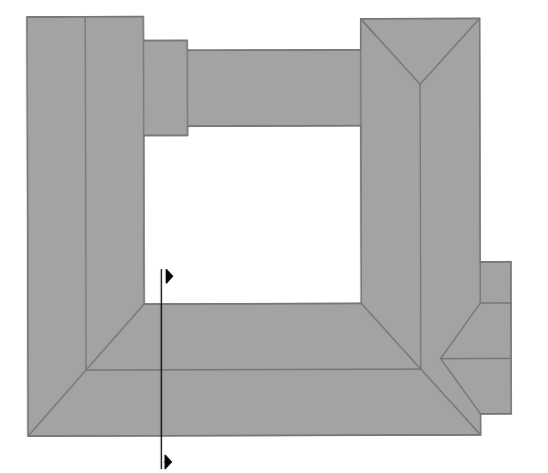

Market hall

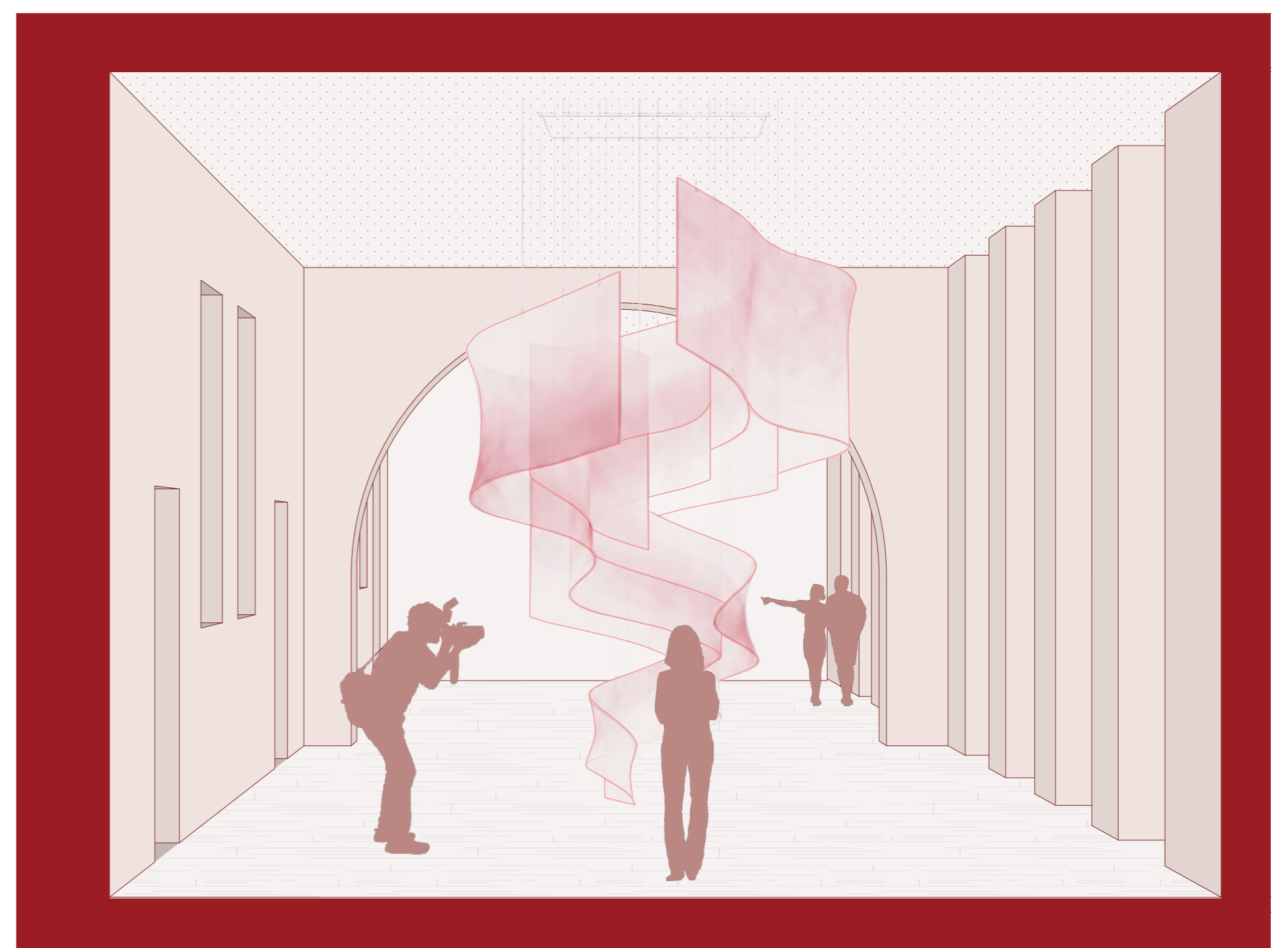

Exhibition Hall

1:50

Close-up Plans
First & Second Floor

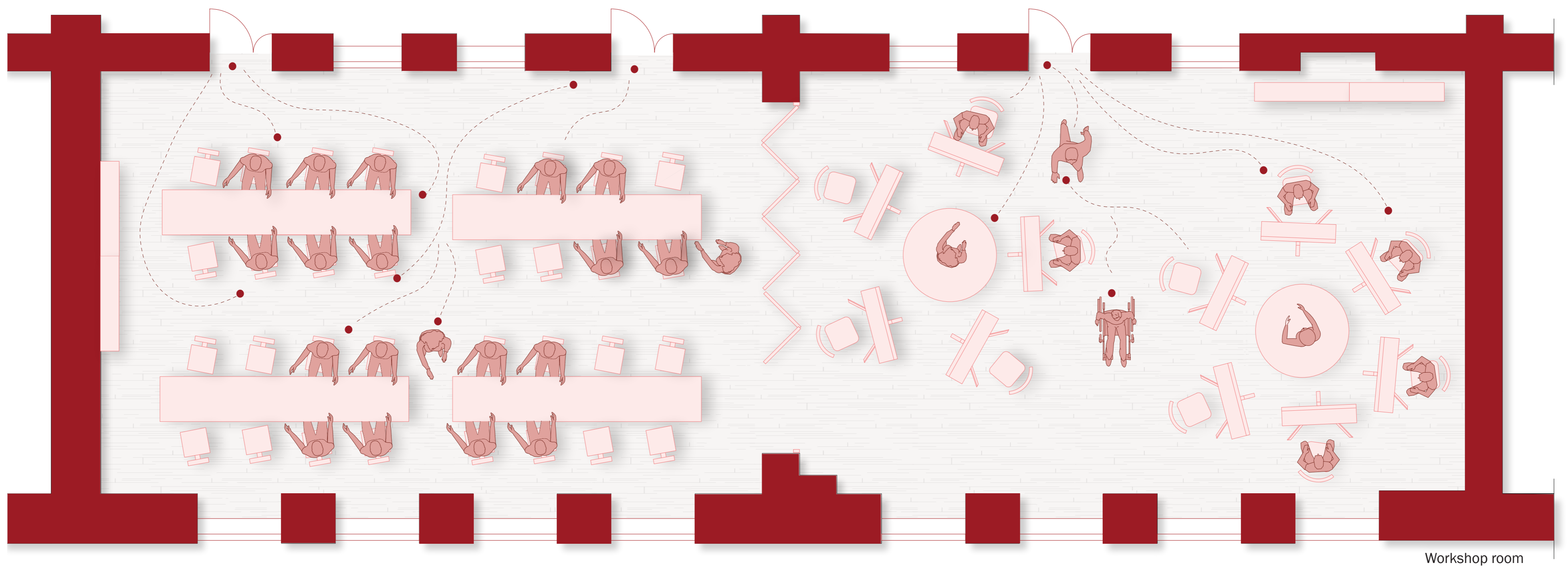

Workshop room

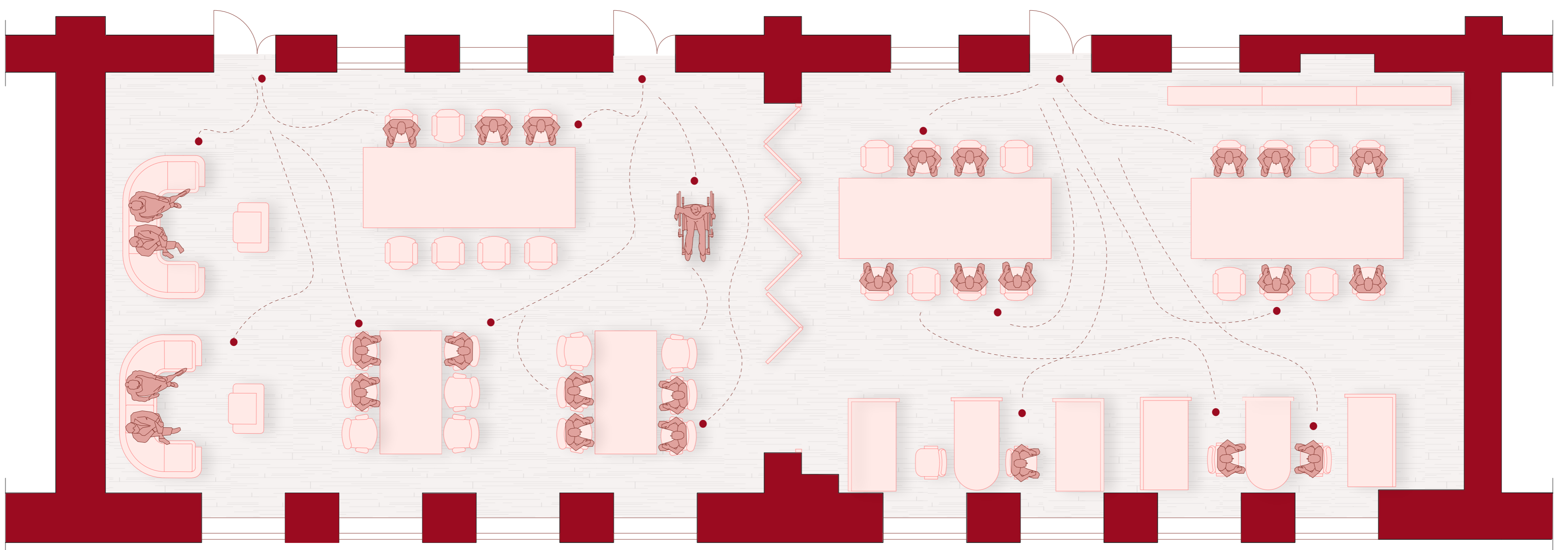

Co-working room

Close-up Sections

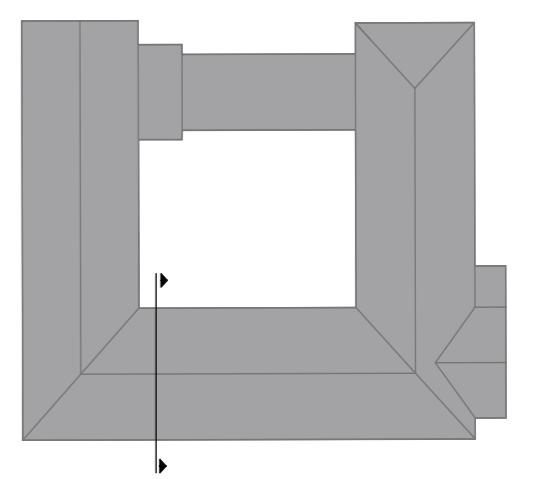

Workshop room



Co-working room

1:50

Collages & Partial Axonometries

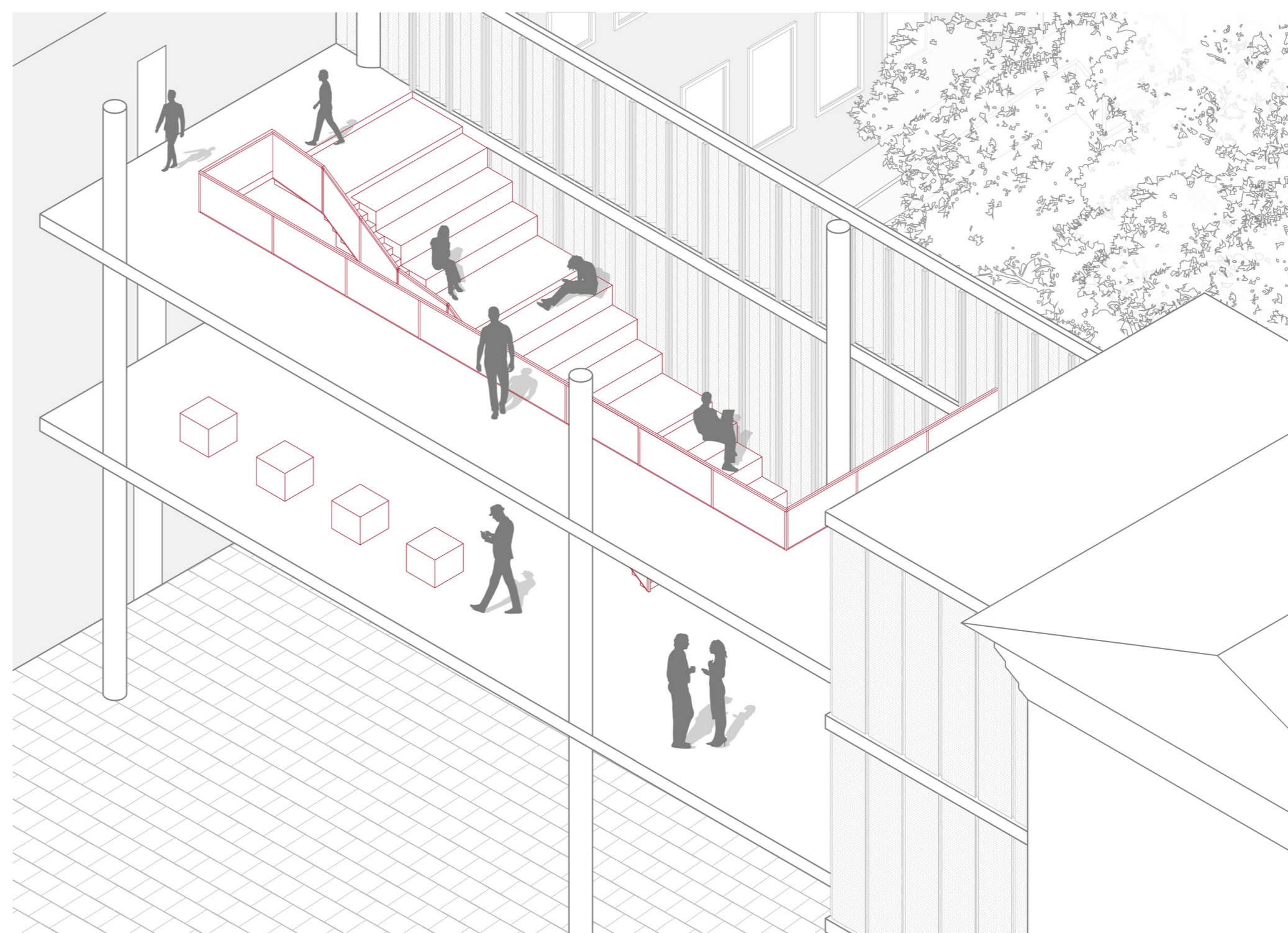

Bridge

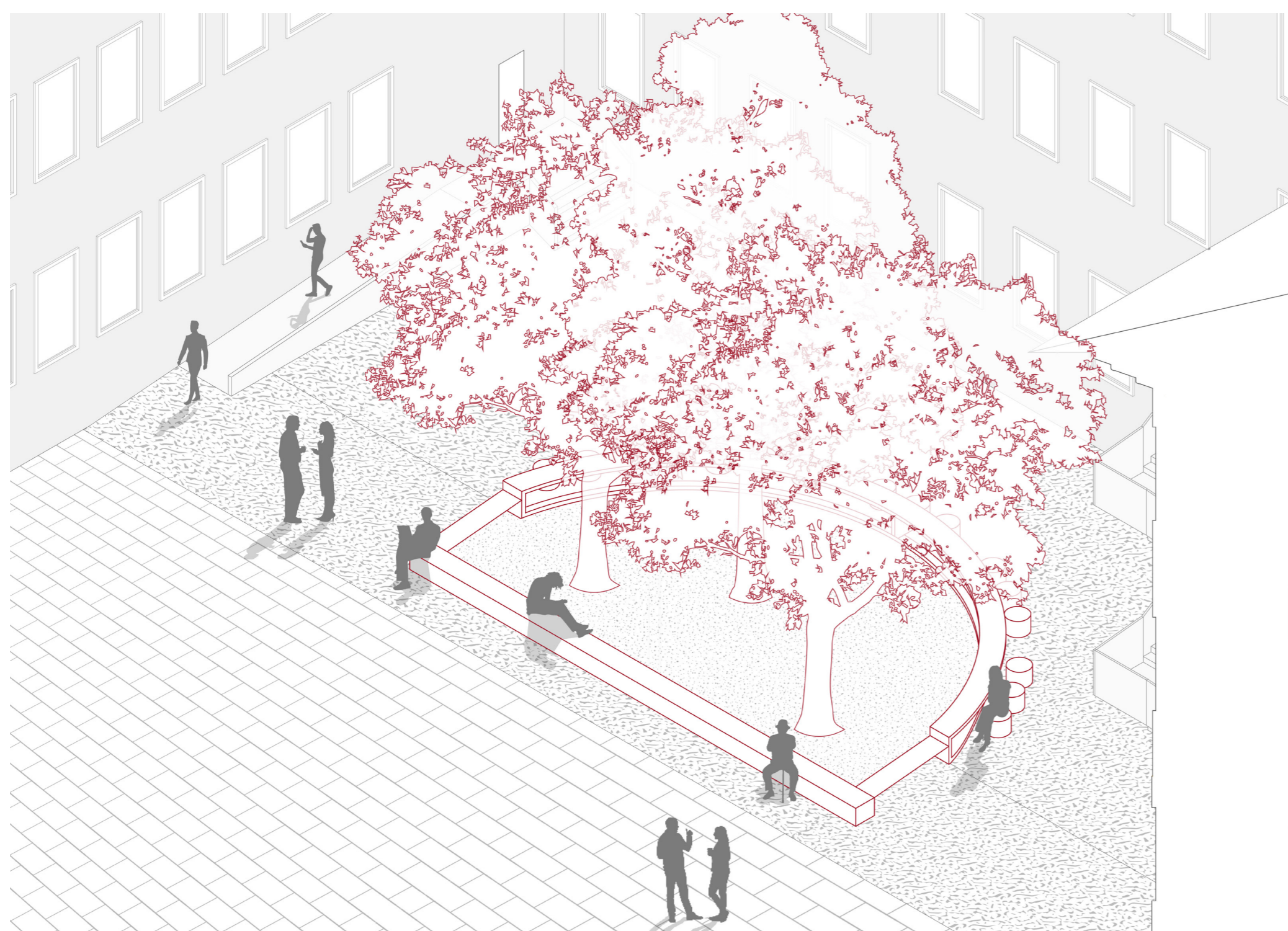

Courtyard

Indoor Collages & Outdoor Axonometries



Market Hall



Co-working room

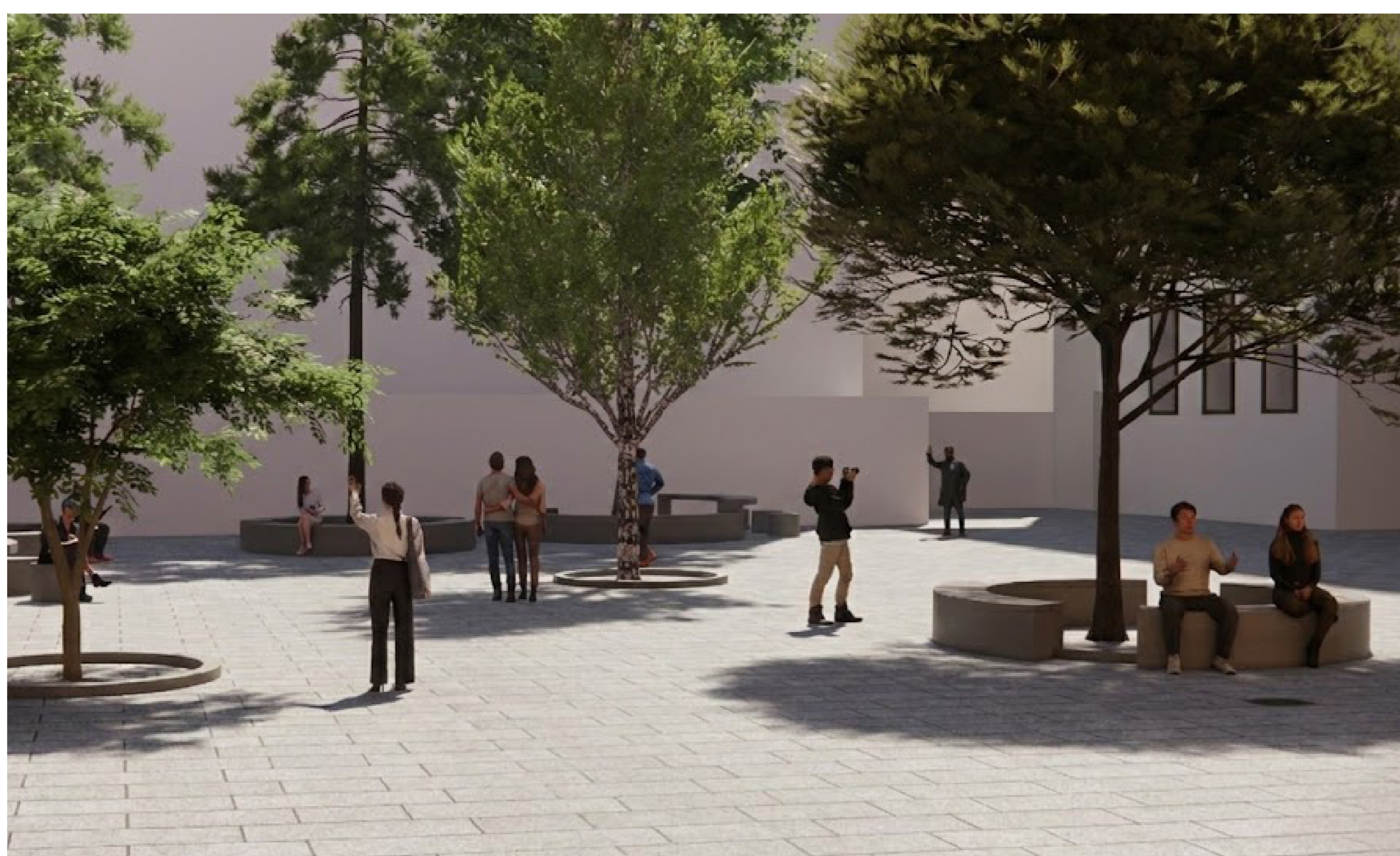

Outdoor Views