

swiveling wall

scale 1:100

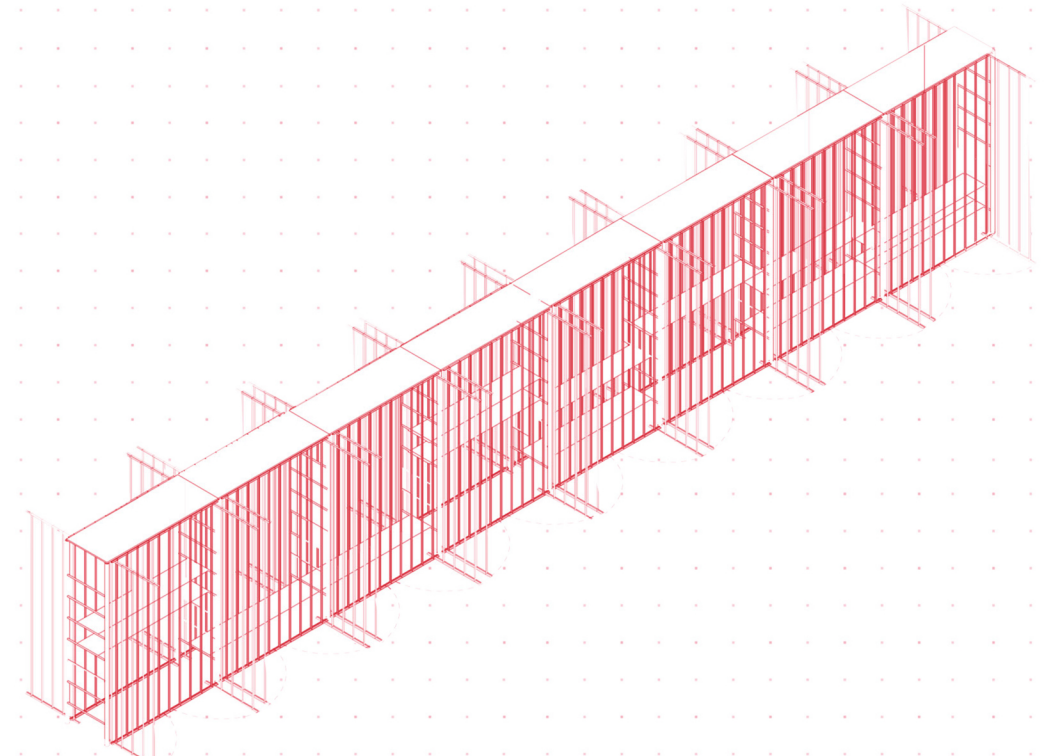

storage wall

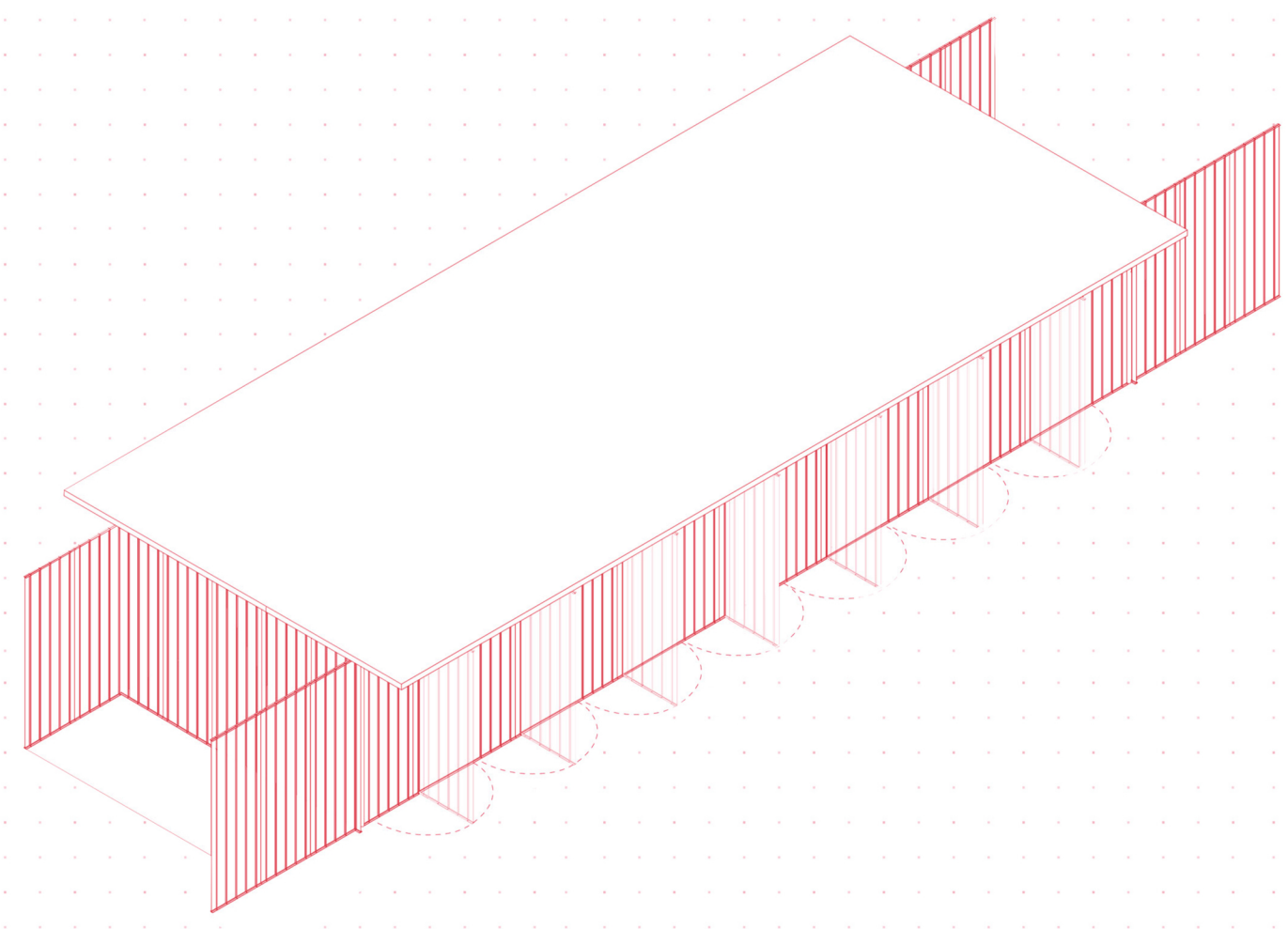

roofed wall

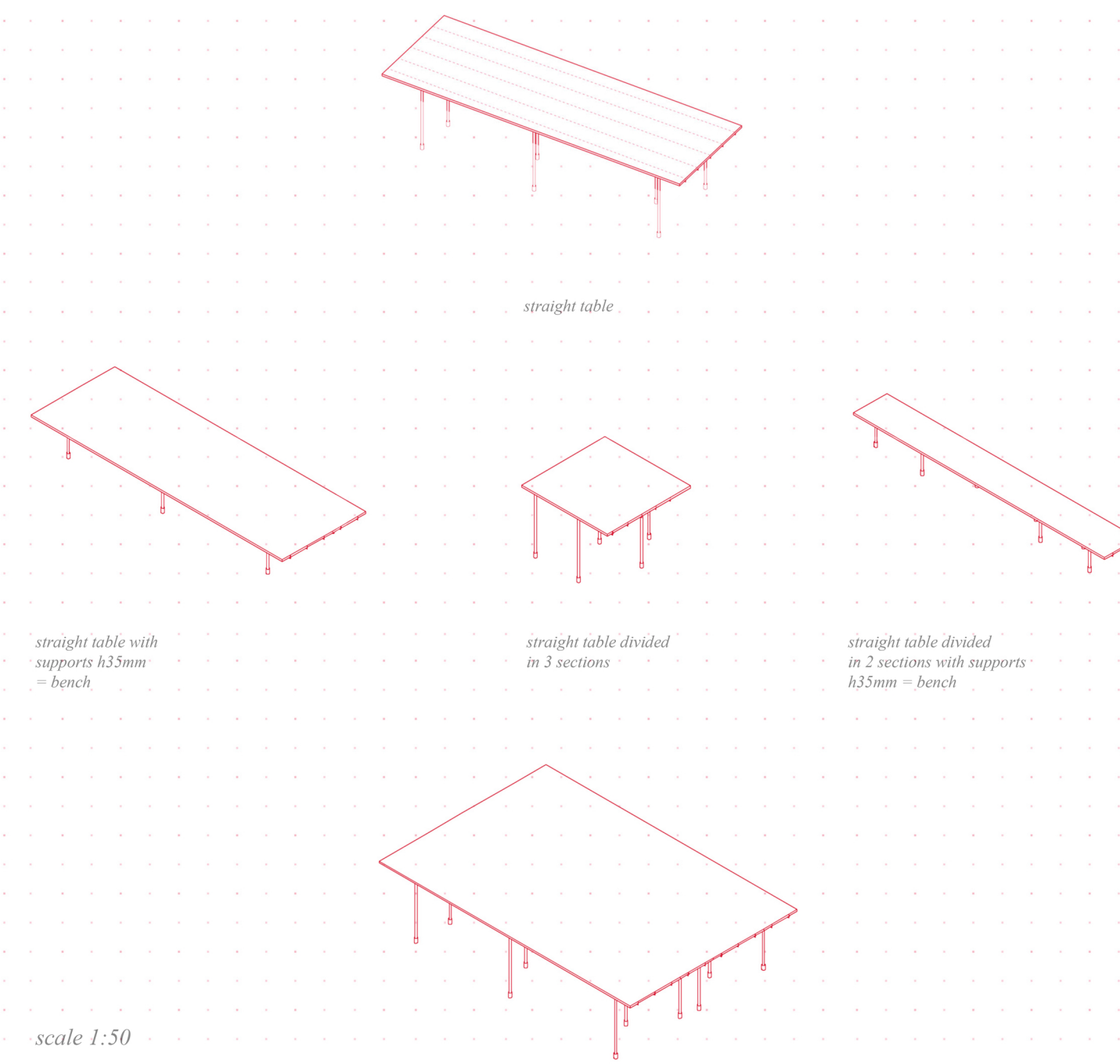

straight table

anklar table

straight table with supports h. 25mm - bench

straight table divided in 3 sections

straight table divided in 2 sections with supports h. 25mm - bench

anklar table with supports h. 25mm - bench

scale 1:50

Type A. module (permeable version)
basic module for swiveling doors

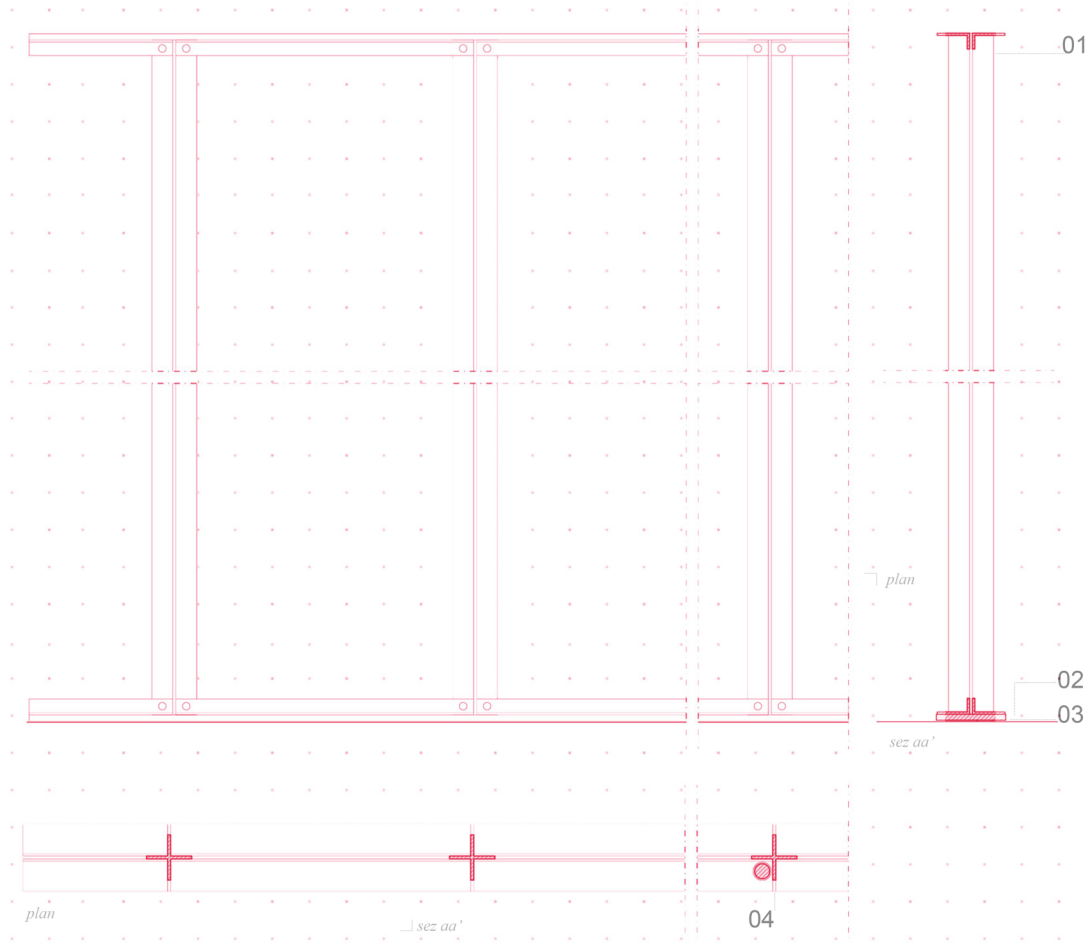

scale 1:5



Type B. module with milled wooden plank

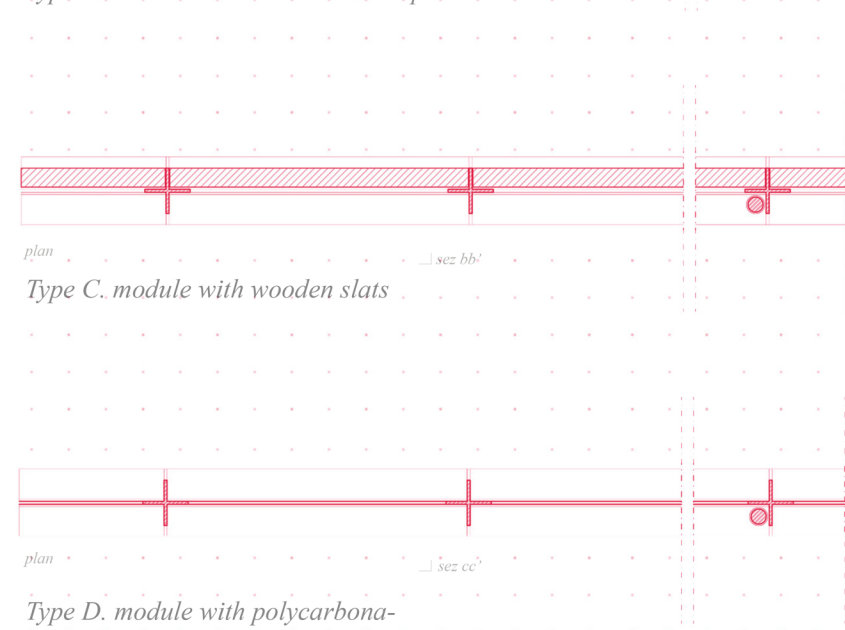

Type C. module with wooden slats



Type D. module with polycarbona-



-21

Storage wall

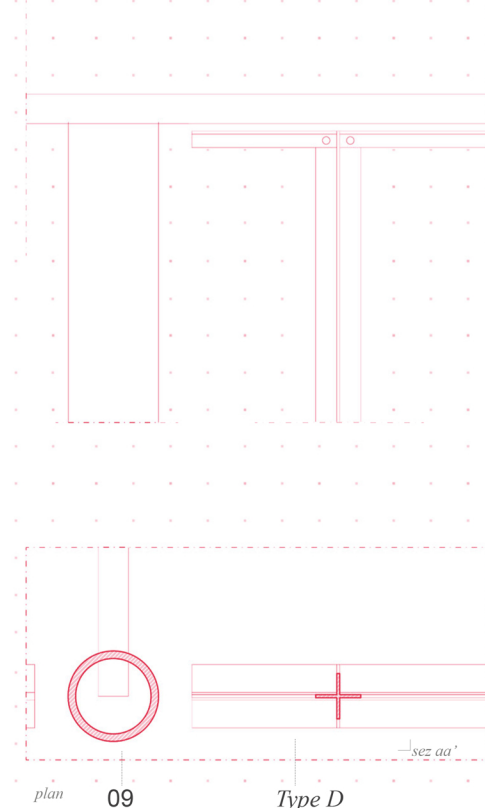

Type A



Type D



Type D

Roofed wall

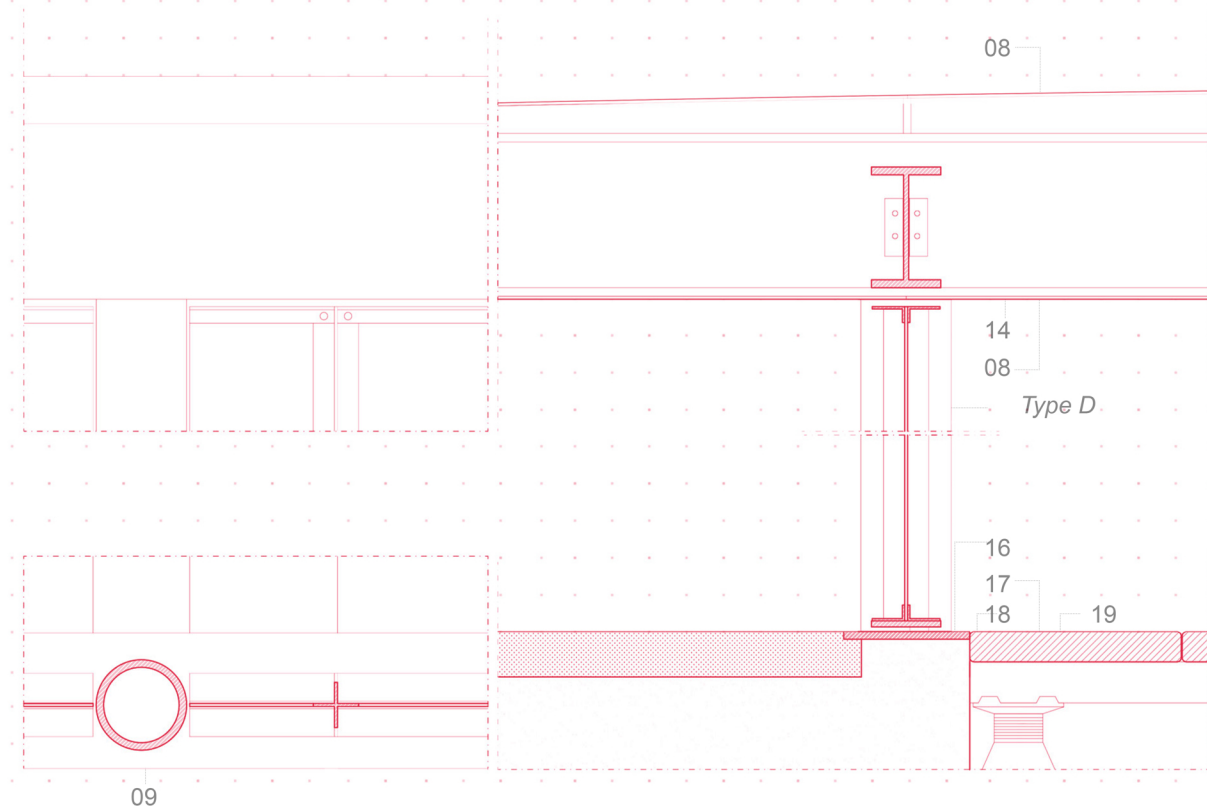

Type D

Furniture system

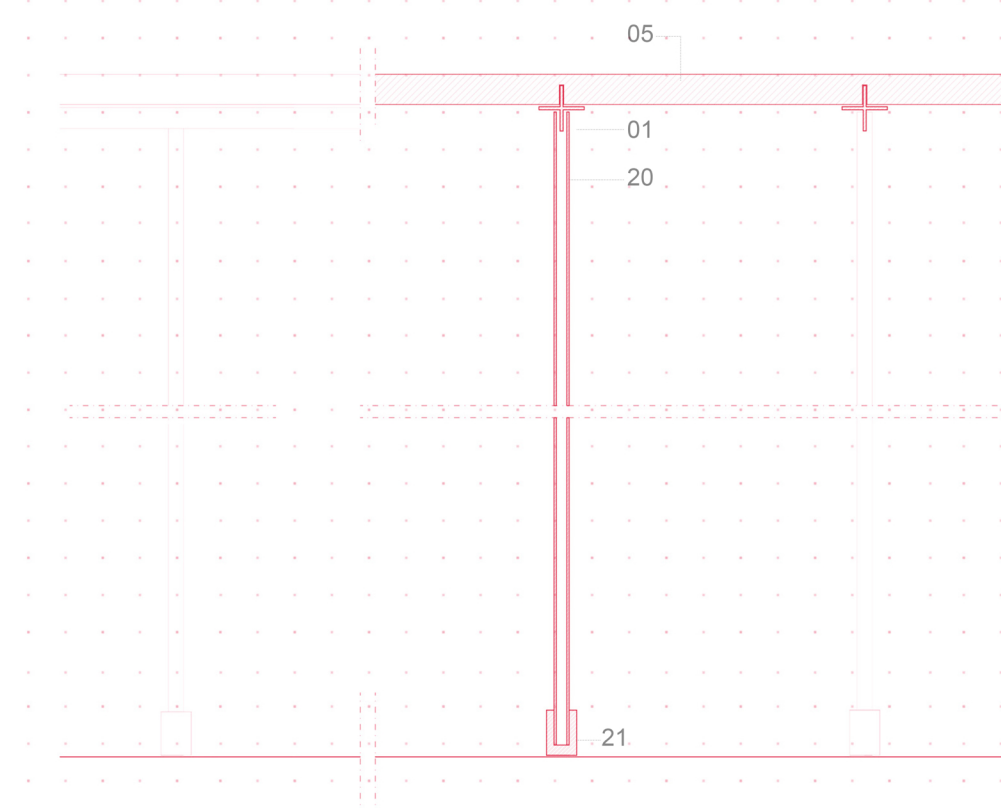

metal cross piece 01
metal L profile 02
metal plates 50mm 03

iron rod d. 15mm 04
milled MDF plank 05
MDF slats 06

polycarbonate sheets 07
metal sheets 2 mm 08
metal tube d. 60mm x 5mm 09

plank 10
screws 11
concrete screw 12

LPE 50mm 13
LPE 100mm 14
metal support 15

metal plate 10mm 16
larch plank long 2 x 4 17
larch subslat 18

metal tube d. 20mm x 2mm 19
metal tube d. 20mm x 2mm 20
metal tube d. 30mm x 5mm 21